

Quad-Band Combiner

KATHREIN

Antennen · Electronic

Preliminary Issue

380 – 960 MHz TETRA / DVB-H / CDMA 800 / GSM 900	1710 – 1880 MHz GSM 1800	1920 – 2200 MHz UMTS	2500 – 2690 MHz LTE 2600
--	------------------------------------	--------------------------------	------------------------------------

- Designed for co-siting purposes
- Enables feeder sharing
- Can be used as a combiner near the BTS or in a reciprocal function near the antenna
- Suitable for indoor or outdoor applications
- Wall or mast mounting
- Available as a single unit, or for XPol antennas as a double unit
- Built-in lightning protection
- External DC Stop available as an accessory

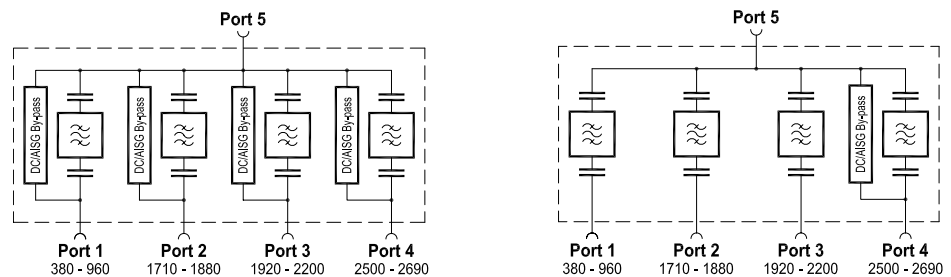
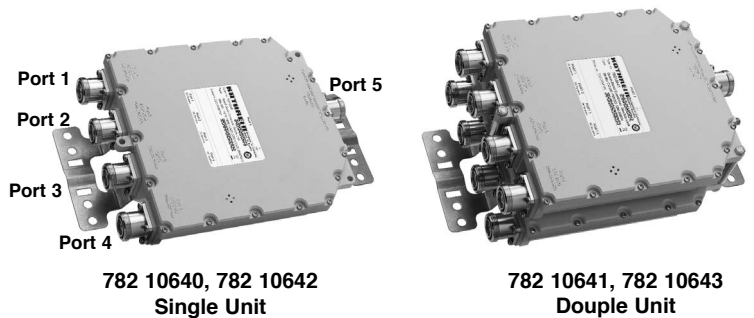

Technical Data

Type No.	782 10640 Single Unit	782 10642 Single Unit
	782 10641 Double Unit	782 10643 Double Unit
Pass band Band 1 (TETRA ... GSM 900) Band 2 (GSM 1800) Band 3 (UMTS) Band 4 (LTE 2600)	380 – 960 MHz 1710 – 1880 MHz 1920 – 2200 MHz 2500 – 2690 MHz	
Insertion loss Port 1 ↔ Port 5 Port 2 ↔ Port 5 Port 3 ↔ Port 5 Port 4 ↔ Port 5	< 0.2 dB (380 – 960 MHz) < 0.3 dB (1710 – 1880 MHz) < 0.3 dB (1920 – 2200 MHz) < 0.2 dB (2500 – 2690 MHz)	
Isolation Port 1 ↔ Port 2 Port 1 ↔ Port 3 Port 1 ↔ Port 4 Port 2 ↔ Port 3 Port 2 ↔ Port 4 Port 3 ↔ Port 4	> 45 dB (380 – 600 MHz) / > 50 dB (600 – 960 / 1710 – 1880 MHz) > 45 dB (380 – 600 MHz) / > 50 dB (600 – 960 / 1920 – 2200 MHz) > 45 dB (380 – 600 MHz) / > 50 dB (600 – 960 / 2500 – 2690 MHz) > 50 dB (1710 – 1880 / 1920 – 2200 MHz) > 50 dB (1710 – 1880 / 2500 – 2690 MHz) > 50 dB (1920 – 2200 / 2500 – 2690 MHz)	
VSWR	< 1.25 (380 – 960 / 1710 – 1880 / 1920 – 2200 / 2500 – 2690 MHz)	
Impedance	50 Ω	
Input power Band 1 / Band 2 / Band 3 / Band 4	< 700 W / < 300 W / < 300 W / < 200 W	
Intermodulation products	< -160 dBc (3 rd order; with 2 x 20 W)	
Temperature range	-40 ... +60 °C	
Connectors	7-16 female (long neck)	
Application	Indoor <i>or</i> outdoor (IP 66)	
DC/AISG transparency Port 1 ↔ Port 5 Port 2 ↔ Port 5 Port 3 ↔ Port 5 Port 4 ↔ Port 5	Max. 2500 mA By-pass By-pass By-pass By-pass	Max. 2500 mA Stop Stop Stop By-pass
Lightning protection	3 kA, 10/350 μs pulse	
Mounting	Wall mounting: With 4 screws (max. 8 mm diameter) / Mast mounting: With additional clamp set	
Weight	Single Unit: Approx. 4 kg / Double Unit: Approx. 8 kg	
Dimensions (w x h x d)	Single Unit: 214 x 228 x 52 mm / Double Unit: 214 x 228 x 108 mm (without connectors, without mounting brackets)	

936.A2634/b Subject to alteration.

Quad-Band Combiner

KATHREIN

Antennen · Electronic

Preliminary Issue

380 – 960 MHz TETRA / DVB-H / CDMA 800 / GSM 900	1710 – 1880 MHz GSM 1800	1920 – 2200 MHz UMTS	2500 – 2690 MHz LTE 2600
--	------------------------------------	--------------------------------	------------------------------------

Accessories (order separately)

Type No.	Clamp set suitable for mast diameter of
734 360	34 – 60 mm
734 361	60 – 80 mm
734 362	80 – 100 mm
734 363	100 – 120 mm
734 364	120 – 140 mm
734 365	45 – 125 mm



Type No.	Description
793 301	DC stop
784 10367	50-Ω load 1.5 W / indoor or outdoor



Typical Attenuation Curves

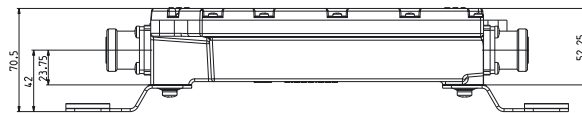
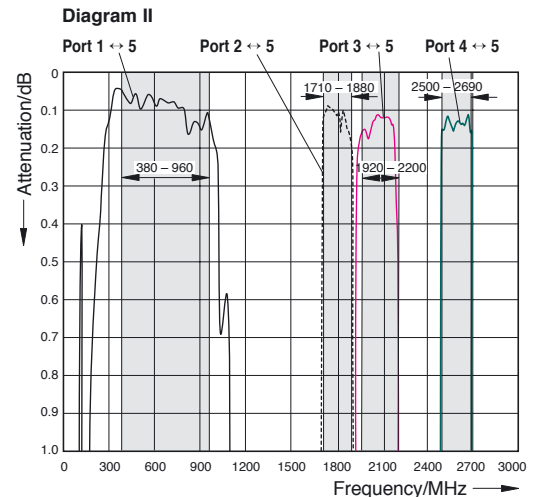
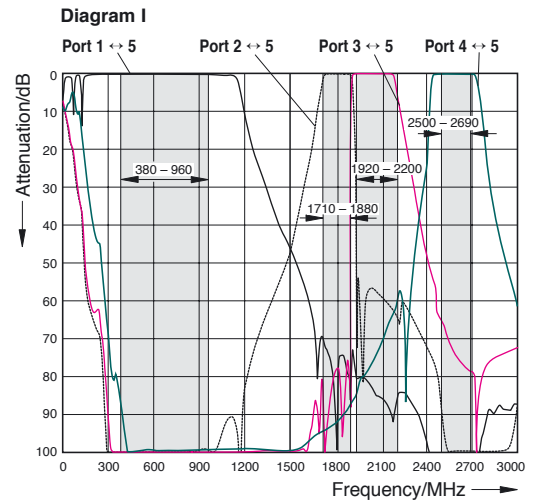

Side view
Single Unit

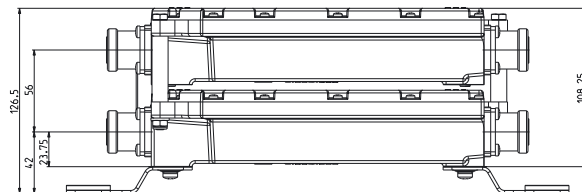

Side view
Double Unit

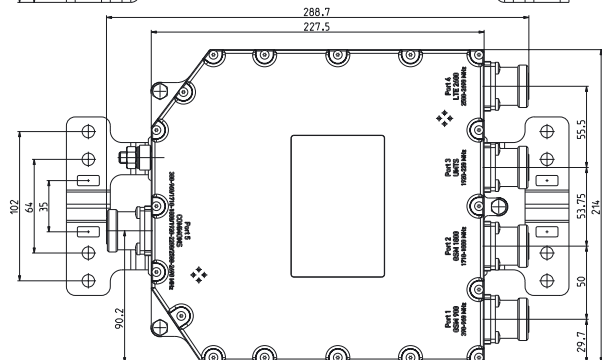

Top view
Single Unit,
Double Unit

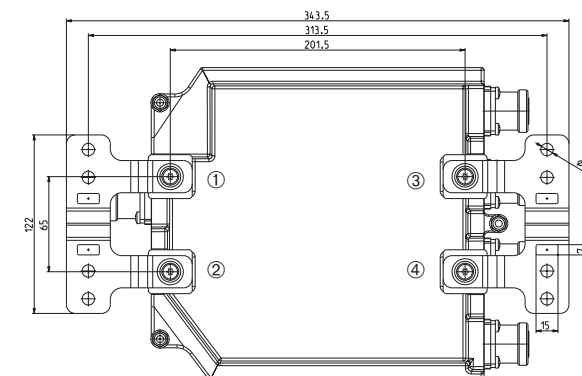

Bottom view
Single Unit,
Double Unit

Please note:

The mounting plates can be removed by loosening the screws ① to ④ (M5 x 12) and replaced with other means of mounting, always provided that the max. drilled depth of 7.5 mm is respected with the choice of replacement screws.

As a result of more stringent legal regulations and judgements regarding product liability, we are obliged to point out certain risks that may arise when products are used under extraordinary operating conditions.

Extraordinary operating conditions, such as heavy icing or exceptional dynamic stress (e.g. strain caused by oscillating support structures), may result in the breakage of a mast mounted device or even cause it to fall to the ground.

These facts must be considered during the site planning process.

The Quad-band Combiners are designed to operate under the environmental conditions as described in ETS 300 019-1-4 class 4.1 E and have passed environmental tests as recommended in ETS 300 019-2-4.

The installation team must be properly qualified and also be familiar with the relevant national safety regulations.

The details given in our data sheets have to be followed carefully when installing the antennas, filters, combiners, amplifiers and accessories.

The limits for the coupling torque of RF connectors, recommended by the connector manufacturers must be obeyed.

Terminate unused inputs with a suitable 50-Ω load, e.g. 784 10367.

Any previous datasheet issues have now become invalid.



Subject to alteration. 936.A2634/b