

ABC1200 / ABE1200 Series

1200 W AC-DC Power Supplies

The ABC1200 / ABE1200 Series of AC-DC power supplies provide a steady 1200 W of regulated DC power through 180-305 VAC and 1000 W through 85-137 VAC input voltage ranges in a single output of 24 or 48 VDC, offering 12 and 5 VSB standby outputs and a full set of protection features.

The ABC1200 / ABE1200 Series is available in three compact 1U height compatible packages. One is enclosed with a built-in front mounted pair of fans and two (available only 24 V variant), U-shaped chassis with or without protective cover, to facilitate system integration.

The ABC1200 / ABE1200 Series supports digital power management over the Power Management Bus communications protocol. Multiple units may be connected in parallel for redundancy and / or higher power, enabled with the internal OR-ing and current sharing functions.

The ABC1200 / ABE1200 Series complies with the latest international safety standards and displays the CE-Mark for the European Low Voltage Directive (LVD).



Key Features & Benefits

- Universal input voltage range (85 – 305 VAC)
- Input inrush current limiting
- 1200 W rated power
- High efficiency up to 94%
- Single 24 VDC or 48 VDC output voltages available
- Active PFC, EN61000-3-2 compliant (Class C, >25% load)
- Low earth / touch leakage current
- Fan speed control function
- 800 LFM airflow for ABC1200 models
- Over temperature, OV, OC and SC protections
- +12 V, 0.5 A; +5 V, 1 A Stand by outputs
- Built-in current sharing and OR-ing for parallel operation and N+1 redundancy
- Remote On / Off signal
- Power good and remote sense signals
- Power Management Bus communication protocol supported
- Safety approvals to IEC/EN/UL 62368-1
- LED lighting approval to UL 8750

Applications

- Video Wall Display, Entertainment Lighting
- LED Lighting Engine
- Industrial Control Systems
- Industrial Laser Applications



bel POWER SOLUTIONS & PROTECTION

a bel group

belfuse.com/power-solutions

1. MODEL SELECTION

MODEL NUMBER	PACKAGE & COOLING	INPUT VOLTAGE RANGE [VAC]	NOM. OUTPUT VOLTAGE [VDC]	MAX. OUTPUT POWER [W]	MAX. OUTPUT CURRENT [A]	DIMENSIONS
ABC1200-1T24-UCF	U-chassis, external air flow	85 - 305	24	1200	50	101.6 x 234.0 x 41.0 mm 4.00 x 9.21 x 1.61 in
ABC1200-1T24-PCF	Protective cover, external air flow	85 - 305	24	1200	50	101.6 x 234.7 x 41.0 mm 4.00 x 9.24 x 1.61 in
ABE1200-1T24	Enclosed, front mounted fan	85 - 305	24	1200	50	101.6 x 264.1 x 41.0 mm 4.00 x 10.4 x 1.61 in
ABE1200-1T48	Enclosed, front mounted fan	85 - 305	48	1200	25	101.6 x 264.1 x 41.0 mm 4.00 x 10.4 x 1.61 in

2. INPUT SPECIFICATIONS

PARAMETER	DESCRIPTION / CONDITION	MIN	NOM	MAX	UNIT
AC Input Voltage	PS starts at 85 V _{AC} at all load conditions Operating input voltage range ABC1200 / ABE1200 Series is designed to operate with a square or trapezoidal input voltage wave form (i.e. from UPS)	85	100-277	305	V _{RMS}
DC Input Voltage	Built in fuses safety certified up to 250 V _{DC} . Operating the 1200 Series above that limit up to 300 V _{DC} , does require an external fuse protection *	120	-	300	V _{DC}
Input Frequency	400 Hz (max 440 Hz) operation over 85 – 137 V _{AC} input range	47	50/60	63	Hz
Input Current	At 180 V _{AC} , maximum load, 50 / 60 Hz At 85 V _{AC} , 1000 W load, 50 / 60 Hz 163 V _{DC} , maximum load 120 V _{DC} , 1000 W	-	-	8.0 14.5 9.0 10.0	A _{RMS} A
Inrush Current	At power-on asserted Cold start, 25 °C ambient, full load Any point of the AC input sine	-	-	30 50	A
Fusing	High breaking, 16 / 20 A, 277 V _{AC} (250 V _{DC}) on each AC line.	-	-	16 / 20	A
Efficiency	At 120 V _{AC}	20% rated load	88	-	-
		50% rated load	92	-	-
		100% rated load	92	-	-
Efficiency	At 230 V _{AC}	20% rated load	90	-	-
		50% rated load	93	-	-
		100% rated load	94	-	-
Input Power Consumption	At power on, no load, 100-277 V _{AC} range (ABE1200-1T24 / -1T48) At power on, no load, 100-277 V _{AC} range (ABC1200-1T24-UCF / -PCF) Stand by, no load, nominal 100-277 V _{AC} range	-	7.0 6 4.0	-	W
Power Factor	Any nominal input line voltage, 50/60 Hz, from 50 to 100% maximum load	0.95	-	-	-
THDi	From 50 to 100% rated load, 100-277 V _{AC} , 50/60 Hz.	-	-	20	%
Harmonic Current Fluctuations and Flicker	Complies with EN 61000-3-2 at 230 V _{AC} , 50/60 Hz, Class A, D. Complies with EN 61000-3-2 Class C at 230 V _{AC} , 50/60 Hz, >300 W load. Complies with EN 61000-3-3 at nominal voltages and full load.				
Earth Leakage Current	Normal conditions				
	115 V _{RMS} , 60 Hz	-	130	-	μA
	230 V _{RMS} , 50 Hz	-	240	-	
Touch Leakage Current	264 V _{RMS} , 60 Hz (worst case)	-	-	400	
	264 V _{RMS} , 60 Hz				
	Normal Condition (NC)	-	-	100	μA
	Single Fault Condition (SFC)	-	-	500	

* Suggested fuse SIBA 5012434.16 and fuse holder SIBA 5105805.1

3. OUTPUT SPECIFICATIONS

PARAMETER	DESCRIPTION / CONDITION	MIN	NOM	MAX	UNIT
V1 Output Voltages	±0.5% set point accuracy RS+ closed on +V1, RS- closed on V1 RTN, at 6% load.	-	24 48	-	V
V1 Output Power Rating	85 – 137 V _{AC} ABC1200-1T24-UCF / -PCF (800 LFM); (120-163 V _{DC}) ABE1200-1T24 / ABE1200-1T48 180 – 305 V _{AC} ABC1200-1T24-UCF / -PCF (800 LFM); (163-300 V _{DC}) ABE1200-1T24 / ABE1200-1T48			1000 1200	W
V1 Output Current	85 – 137 V _{AC} ABC1200-1T24-UCF / -PCF; ABE1200-1T24 (120-163 V _{DC}) ABE1200-1T48 180 – 305 V _{AC} ABC1200-1T24-UCF / -PCF; ABE1200-1T24 (163-300 V _{DC}) ABE1200-1T48			41.7 20.8 50 20	A
V1 Voltage Adjustment Range	Manually by push up and down buttons	-	±5	-	%V1
V1 Line Regulation	V _{AC} : 85 – 305 V _{RMS}	-	-	±0.1	%V1
V1 Load-Line-Cross Regulation	V _{AC} : 85 – 305 V _{RMS} ; I ₁ : 0 – 100%	-	-	±2	%V1
V1 Ripple and Noise	Rated load, Peak-to-peak, 20 MHz BW. (100 nF ceramic, 10 µF tantalum at load)	-	-	1	%V1
Transient Response: V1, 12V _{SB} , 5V _{SB} Voltage Deviation	25% load changes at 1 A/µs 24 V at 1000 µF load / I _{OUT} > 2.5 A 48 V at 560 µF load / I _{OUT} > 1.25 A 12 V _{SB} , 5 V _{SB} at 0-2200 µF load	-	-	±5	%V1 %V _{SB}
V1 Start-up Rise Time	85 < V _{IN} < 305, any load conditions. At nominal V _{IN} , full load SEMI F47-0706 compliant at ≥208 V _{AC}	10 10	- -	150 -	ms
V1 Hold-up Time					
		50% sag (104 V) 30% sag (145 V) 20% sag (166 V)	200 500 1000	- - -	ms
V1 Current Sharing Accuracy	Parallel operation up to four units. Two units in parallel at I ₁ rated load. I-Share signals connected together. RS+, RS- signals connected together and to the load. Max load at start up 1200 W, operating 2000 W, 180 ÷ 305 V _{AC} . Max load at start up 1000 W, operating 1667 W, 85 ÷ 137 V _{AC} .	40	-	60	%I ₁
V1 Remote Sense	RS+ and RS- power path voltage loss compensation	-	-	0.36	V
Start-up Delay	V1 in regulation after de-asserting PS_Inhibit V1 in regulation after AC is applied (worst case: 85 V _{AC}) 5V _{SB} in regulation after AC is applied (worst case: 85 V _{AC})	- -	- -	1700 2200 500	ms
Turn-on Overshoot		- -	- -	10 10	%V1 %V _{SB}
Minimum Load	V1, 12V _{SB} , 5V _{SB}	0	-	-	A
Maximum Load Capacitance	V1: 24 V _{DC} V1: 48 V _{DC}	- -	- -	16000 8000	µF
V1 Over Current Protection	V1: 24 V _{DC} V1: 48 V _{DC}			75 37.5	A
12 V _{SB} Output Voltage	V _{SB} output voltage is referred to the same V1 output voltage return	-	12	-	V
12 V _{SB} Output Current	All models up to 70 °C	-	-	0.5	A
12 V _{SB} Ripple & Noise	Peak-to-peak			120	mV
12 V _{SB} Line Cross Regulation	V _{AC} : 85 – 305 V _{RMS} ; I _{SB} : 0 – 100%	-	-	±5	%V _{SB}
5 V _{SB} Output Voltage	V _{SB} output voltage is referred to the same V1 output voltage return	-	5	-	V
5 V _{SB} Output Current	All models up to 70 °C	-	-	1	A
5 V _{SB} Ripple & Noise	Peak-to-peak			50	mV
5 V _{SB} Load, line cross Regulation	V _{AC} : 85 – 305 V _{RMS} ; I _{SB} : 0 – 100%	-	-	±5	%V _{SB}



Asia-Pacific
+86 755 298 85888

Europe, Middle East
+353 61 49 8941

North America
+353 61 49 8941

3.1 OUTPUT POWER DE-RATING CURVES

Front Fan (Models ABE1200-1T24 / ABE1200-1T48)
Any orientation, V1 nominal

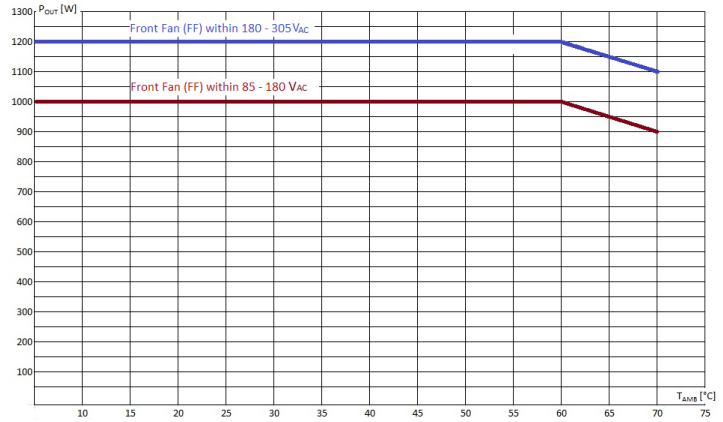
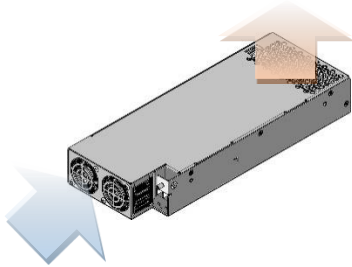

U-Chassis and Perforated Cover
Forced Air Cooling (Models ABC1200-1T24-UCF / -PCF)
Air flow from top, V1 nominal

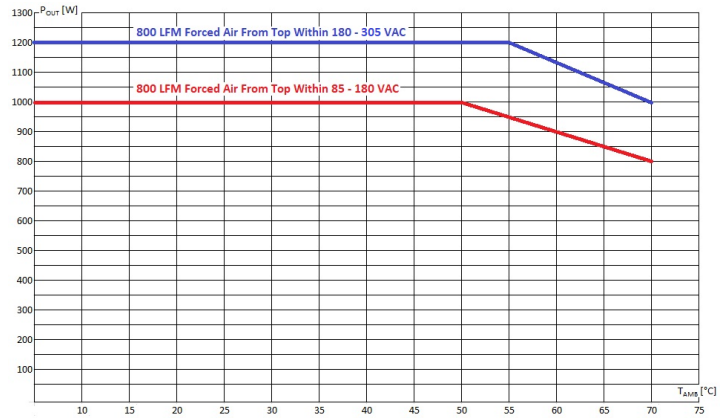
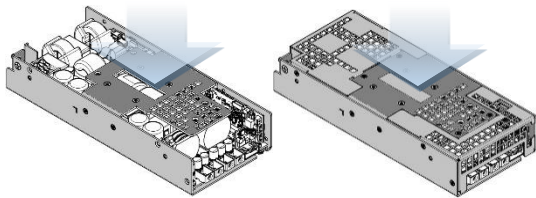

U-Chassis and Perforated Cover
Forced Air Cooling (Models ABC1200-1T24-UCF / -PCF)
Air flow from AC side, V1 nominal

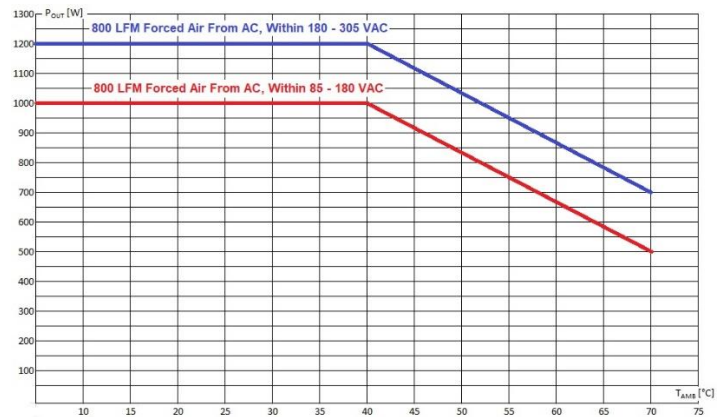
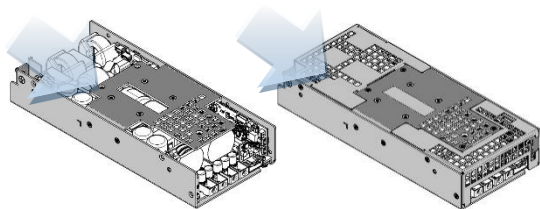

4. POWER MANAGEMENT BUS

The ABC1200 / ABE1200 Series does support communication according to the Power Management Bus 1.2 protocol via SDA, SCL and #SMBALERT signals as defined in the SMBus Specification version 2.0.

The power supply shall not load the SMBus if it has no input power (SCL & SDA lines should go to High-Z).

The pull-up resistors (2.2 kΩ) for these signals shall be external to the power supply and referenced to an external +3.3 V bus voltage.

The DSP circuits inside the power supply are powered by the standby output.

The Power Management Bus is active whatever input power is applied to the power supply or a parallel redundant power supply in the system, provided that their 12V_{SB} are connected in parallel.

Maximum speed of SMBus is 100 kHz.

The ADDR0 and ADDR1 signals, are inputs to the power supply that control the Power Management Bus address assigned to the power supply.

On the system side, the ADDR0 and ADDR1 signals will either be connected to return through a 1 kΩ pull-down resistor or connected to +3.3 V external bus voltage through a 1 kΩ pull-up resistor.

The address shall be derived from the logic of this pin as indicated on Outline Drawing and Connections section.

The power supply is a slave only on SMBus device.

For a comprehensive description of ABC1200 / ABE1200 Series Power Management Bus management, do refer to the application note, "ABC1200 / ABE1200 Series Power Management Bus Mgt". Examples of 1200 W Series parameters available through communication bus are:

- Input voltage status
- Output voltages +V1 measured value
- Output current on +V1 measured value
- Current sharing status
- Thermal health measured value
- Fan health status
- Power-On / Working hours
- Product information
- Status information

Failures shall be reported by Power Management Bus for all failure types:

- Fan fault
- Protections failure (OV, OC, OT)
- Voltages out of specification

5. SIGNALING & CONTROL SPECIFICATIONS

Base signals and controls are accessible from signal connector P204.

SIGNAL	DESCRIPTION / CONDITION	MIN	NOM	MAX	UNIT
+PS_Inhibit (Active High)	Input low voltage ($I_{IN} = 0 \mu A$)	0	-	0.8	V
	Input high voltage ($I_{IN} = 500 \mu A$ at 5.5 V) V1 disabled when PS_Inhibit is pulled high V1 enabled when PS_Inhibit is floating or low 5V _{SB} and 12V _{SB} not affected by PS_Inhibit	2.5	-	5.5	
-PS_Inhibit (Active Low)	Input low voltage ($I_{IN} = -800 \mu A$ at 0 V)	0	-	0.8	V
	Input high voltage ($I_{IN} = -200 \mu A$ at 2.5 V) ($I_{IN} = 700 \mu A$ at 5.5 V) V1 disabled when -PS_Inhibit is pulled low V1 enabled when -PS_Inhibit is floating or high 5V _{SB} and 12V _{SB} not affected by -PS_Inhibit	2.5	-	5.5	
Power_OK * (PS_OK)	Logic level low (<10 mA sinking)	-	-	0.7	V
	Logic level high (200 μA sourcing)	2.4	-	3.45	
	Low to high time after V1 in regulation Power down warning time	150 2	- -	350 -	
I_Share	The I_SHARE signals shall be daisy chained among power supplies operating in parallel. On a single power supply operating it provides current measurement on V1 output. On multiple power supplies operating in parallel, it provides current measurement on master V1 output.				
SDA, SCL, #SMBALERT, ADDR0, ADDR1	These are signals which support Power Management Bus communication protocol as specified in the application note ABC1200 / ABE1200 Series Power Management Bus Mgt.				
RSVD RX, RSVD TX	Mainly intended for internal use, these RX and TX signals - available at the output signal connector P204 - may be used to access some DSP functions (monitoring, threshold settings, debug functions). These signals work as an UART Rx/Tx port and can also work as a RS-232 Rx/Tx port by building in the "RS-232 LINE DRIVERS/RECEIVERS" IC				
5V _{SB} Output **	Active and in regulation after an $85 < V_{AC} < 305$ is applied Not affected by PS_Inhibit. Available on P204, pin#4	-	-	500	ms
12V _{SB} Output ***	Active and in regulation after an $85 < V_{AC} < 305$ is applied Not affected by PS_Inhibit. Available on P204, pin#16	-	-	500	ms

* When V1 is On, a P_OK low may indicate V1 under voltage condition. When two 1200 W models operate in parallel, P_OK low in one unit indicates that it is not sharing the expected amount of current (current sharing fault). A 3.3 k Ω internal pull up to a 3.3 V internal reference voltage is used; do not add any other external pull up.

** The 5V_{SB} outputs of two or more 1200 W models operating in parallel, cannot be connected in parallel in turn, since doing so results in power supplies damage.

*** The 12V_{SB} outputs of two or more 1200 W models operating in parallel can be connected in parallel in turn, taking into account that the maximum available power will not be higher of a single operating power supply one.

5.1 BASE SIGNALS / CONTROLS TIMING

AC/DC INPUT OFF-TO-ON AND ON-TO-OFF TIMINGS

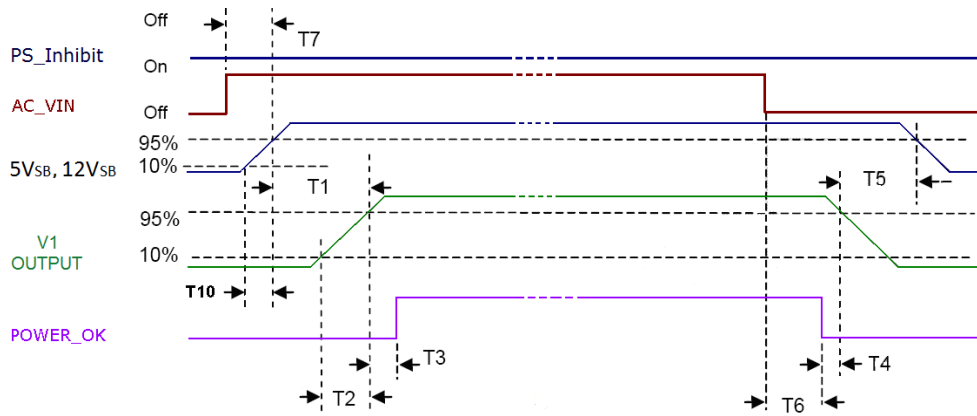

12V _{SB} /5V _{SB} On to V1 On	250 ms ≤ T1 ≤ 1700 ms
V1 rise time	10 ms ≤ T2 ≤ 150 ms
12V _{SB} /5V _{SB} rise time	3 ms ≤ T10 ≤ 150 ms
V1 On – POWER_OK delay	150 ms ≤ T3 ≤ 350 ms
Power down warning	T4 ≥ 2 ms
V1 Off to 12V _{SB} /5V _{SB} Off	T5 ≥ 0.5 s (V1 load > 25 W)
AC Off to POWER_OK low	T6 ≥ 8 ms
AC_On to 12V _{SB} /5V _{SB} On	T7 ≤ 500 ms

PS_INHIBIT OFF-TO-ON AND ON-TO-OFF TIMINGS

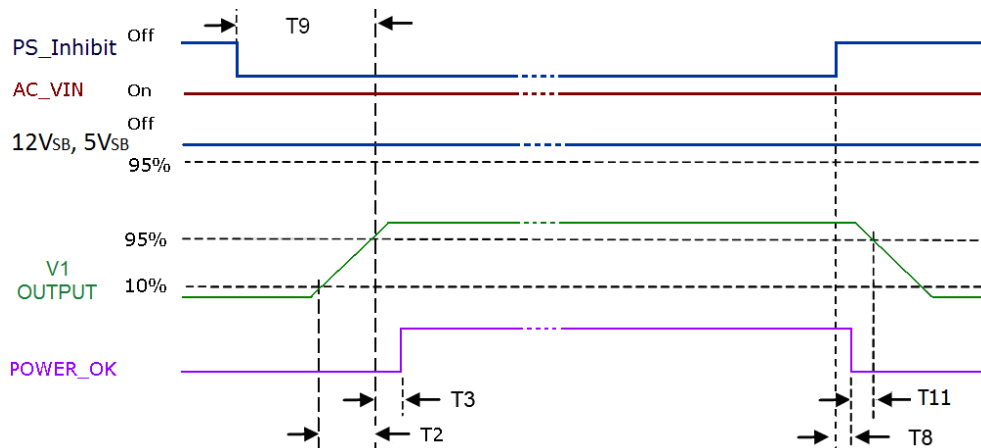

V1 rise time	10 ms ≤ T2 ≤ 150 ms
V1 On – POWER_OK delay	150 ms ≤ T3 ≤ 350 ms
Turn-Off warning	T11 ≥ 1 ms
PS_Inhibit – POWER_OK low delay	T8 ≤ 3 ms
PS_Inhibit – V1 On delay	T9 ≤ 1700 ms

6. PROTECTION SPECIFICATIONS

PARAMETER	DESCRIPTION / CONDITION	MIN	NOM	MAX	UNIT
Input Under Voltage	Auto-recovering, hiccup mode.	58	75	82	V _{AC}
Input Fuse	High breaking, 16 / 20 A, 277 V _{AC} (250 V _{DC}) on each AC lines.	-	-	16/20	A
Over Current	At nominal input voltages	-	-	150	%I _{Rated}
	V1: Hiccup mode, auto-recovering	-	-	-	A
	5V _{SB} : Auto-recovering	-	-	-	A
	12V _{SB} : Hiccup mode, auto-recovering	-	-	-	A
Short Circuit	See Output Ratings Table section	-	-	-	-
	At nominal input voltages	-	-	-	-
	V1: Hiccup mode or latch	-	-	-	-
	5V _{SB} : Auto-recovering	-	-	-	-
Over Voltage	12V _{SB} : Hiccup mode, auto-recovering.	116	-	145	%V _{NOM}
	V1, Power shut down, latch off.	-	-	150	-
Over Temperature (ambient)	Hiccup mode, auto-recovering.	70	-	-	°C
Over Temperature (on secondary side)	Hiccup mode, auto-recovering.	-	-	-	°C
Fan Fault Protection	Relevant to the ABE1200-1T24 / ABE1200-1T48 models. The DSP monitors the signals (frequency generator) provided by both fans. If one fan fails, the DSP asserts maximum speed the other fan and provides an alarm indication through Power Management Bus. If both fans fail, the DSP provides an alarm indication through LED and through Power Management Bus and after 20 s, does shut down V1. PS INHIBIT or AC/DC input have to be cycled to resume operations, after removed the fault.	-	-	-	-
Isolation: Primary-to-Secondary	Reinforced	5660	-	-	V _{DC}
		4000	-	-	V _{AC}
Isolation: Input-to-Earth	Basic Production tested at 2642 V _{DC}	2642	-	-	V _{DC}
		1865	-	-	V _{AC}
Isolation: Output-to-Earth	Basic	1500	-	-	V _{AC}
Equipment Protection Class	Class I	-	-	-	-

7. ENVIRONMENTAL SPECIFICATIONS

PARAMETER	DESCRIPTION / CONDITION	MIN	NOM	MAX	UNIT
Operating Temperature Range	No derating up to 60 °C (ABE1200) and up to 55 °C (ABC1200) See derating curves above 1200 W starts at -40 °C upon warm up delay	-20	-	60	°C
Operating Temperature Range with Derating	See derating curves and conditions in the Output Specifications section	-	-	70	°C
Storage Temperature	As per IEC/EN 60721-3-1 Class 1K4	-40	-	85	°C
Transportation Temperature	As per IEC/EN 60721-3-2 Class 2K4	-	-	-	-
Humidity	RH, Non-condensing Operating.	-	-	90	%
	Non-operating	-	-	95	%
Operating Altitude	Power derating above 1800 m	-	-	5000	m
Shock	EN 60068-2-27	-	-	-	-
	Operating: Half sine, 30 g, 18 ms, 3 axes, 6x each (3 positive and 3 negative). Non-Operating: Half sine, 50 g, 11 ms, 3 axes, 6x each (3 positive and 3 negative).	-	-	-	-
Vibration	EN 60068-2-64	-	-	-	-
	Operating: Sine, 10 – 500 Hz, 1 g, 3 axes, 1 oct/min., 60 min. Random, 5 – 500 Hz, 0.02 g ² /Hz, 1 g _{RMS} , 3 axes, 30 min.	-	-	-	-
	Non-Operating: 5 – 500 Hz, 2.46 g _{RMS} (0.0122 g ² /Hz), 3 axes, 30 min.	-	-	-	-
MTBF	Full load, 25 °C ambient, 100% duty cycle,	700000	-	-	Hours
	Full load, 40 °C ambient, 75% duty cycle Telcordia SR-332 Issue 2	600000	-	-	-
Useful Life	Nominal V _{IN} , 80% load, 40 °C ambient (IPC9592)	-	7	-	Years

8. ELECTROMAGNETIC COMPATIBILITY (EMC) – EMISSIONS

PARAMETER	DESCRIPTION / CONDITION	STANDARD	PERFORMANCE CLASS
Conducted	115, 230, 277 V _{RMS} , Maximum load	EN 55032 EN 55011 (ISM) FCC Part 15	B
Radiated		EN 55032 EN 55011 (ISM) FCC Part 15	B *
Line Voltage Fluctuation & Flicker	At 20%, 50% and 100% maximum load Nominal input voltages	EN 61000-3-3	
Harmonic Current Emission	230 VAC input voltage, 50 / 60 Hz 230 VAC 50 / 60 Hz, >300 W load	EN 61000-3-2 EN 61000-3-2	A, D C

* Performance referred to the enclosed package with additional HF chokes on input, output power and signal cables. Radiated emission relevant to the UCF and PCF package variants, should be assessed at system level.

9. ELECTROMAGNETIC COMPATIBILITY (EMC) – IMMUNITY

PARAMETER	DESCRIPTION / CONDITION	STANDARD	TEST LEVEL	CRITERIA
	Reference standard for ITE Reference standard for Industrial/IMS equipment	EN 55024 EN 61000-6-2		
ESD	15 kV air discharge, 8 kV contact, at any point of the system.	EN 61000-4-2	4	A
Radiated Field	10 V/m, 20-2700 MHz, 1 KHz, 80% AM.	EN 61000-4-3	3	A
Electric Fast Transient	±2 kV on AC power port for 1 minute	EN 61000-4-4	3	A
Surge	±2 kV line to line; ± 4 kV line to earth on AC power port	EN 61000-4-5	4	A
Conducted RF Immunity	10 V _{RMS} , 0,15-80 MHz, 1 kHz, 80% AM	EN 61000-4-6	3	A
Dips and Interruptions	200 – 277 V _{AC} : Drop-out to 0% for 10 ms Dip to 40% for 5 cycles (100 ms) Dip to 70% for 25 cycles (500 ms) Drop-out to 0% for 5 s	EN61000-4-11 EN61000-4-11 EN61000-4-11 EN61000-4-11		A* A (derate to 900 W) A B
	100 – 127 V _{AC} : Drop-out to 0% for 10 ms Dip to 40% for 5 cycles (100 ms) Dip to 70% for 25 cycles (500 ms) Drop-out to 0% for 5 s	EN 61000-4-11 EN 61000-4-11 EN 61000-4-11 EN 61000-4-11		A* A (derate to 400 W) A (derate to 700 W) B

* Performance referred to +5VSB, +12VSB and V1 (PS_OK goes to low level after 8 ms as per timing described at page 8)

10. SAFETY AGENCIES APPROVALS

CERTIFICATION BODY	SAFETY STANDARDS	CATEGORY
CSA / UL	CSA C22.2 No. 60950-1, UL 60950-1, UL 62368-1; UL8750, CSA22.2 No. 250.13	Audio Video and Information Technology Equipment
IEC IECCE CB Certification	IEC/EN 62368-1	LED Lighting Audio Video and Information Technology Equipment
CE	Directive 2014/35/EU: Electrical Safety: Low Voltage electrical equipment (LVD) Directive 2014/30/EU: Electromagnetic Compatibility (EMC) Directive 2015/863/EU: RoHS 3	Audio Video and Information Technology Equipment
Meets all essential requirements of the standard IEC/EN/UL/CSA 61010-1 2nd edition		



Asia-Pacific
+86 755 298 85888

Europe, Middle East
+353 61 49 8941

North America
+353 61 49 8941

11. CONNECTIONS AND PIN DESCRIPTION

CONNECTIONS	CONNECTOR	REFERENCE	FUNCTION
AC Input Connections	P1: AMTEK TB25C-B02P-13-00A-L M4 GROUND STUD	1	Line 1
		2	Line 2
		3	Protection Earth
DC Input Connections	P200, P201, P202, P203: BRASS M4 THREADED TERMINALS (tight to 0.8 – 1 Nm, max. deep screws 7 mm)		24 V Optional 24 / 48 V
		P200	+V1 +V1
		P201	+V1 -
		P202	V1 RTN V1 RTN
		P203	V1 RTN -
Signal Connector	P204: MOLEX 501876-1640	1	RMT (-)
		2	RMT (+)
		3	I-SHARE
		4	+5V _{SB}
		5	PS_INHIBIT
		6	PS_OK
		7	SCL
		8	SDA
		9	#SMBALERT
		10	ADDR0
		11	-PS_INHIBIT
		12	ADDR1
		13	RSVD_RX (OUT)
		14	RSVD_TX (OUT)
		15	RTN
		16	+12V _{SB}
Additional Control Functions	SW600	V1_ADJ (UP)	
	SW601	V1_ADJ (DOWN)	
	DL600	Bi-colour LED	
	Off	No AC/DC input power provided	
	Blinking Green	Input power good, standby active, V1 inhibited	
	Steady Green	V1 Active	
	Steady or Blinking red	Power Supply Fault	

12. MECHANICAL SPECIFICATIONS

PARAMETER	DESCRIPTION / CONDITION
Weight	1150 g (2.53 lb) – ABC1200-1T24-UCF
	1250 g (2.75 lb) – ABC1200-1T24-PCF
	1550 g (3.42 lb) – ABE1200-1T24 / ABE1200-1T48
Overall Dimensions	101.6 x 234.0 x 41.0 mm (4.00 x 9.21 x 1.61 in) – ABC1200-1T24-UCF
	101.6 x 234.7 x 41.0 mm (4.00 x 9.24 x 1.61 in) – ABC1200-1T24-PCF
	101.6 X 264.1 x 41.0 mm (4.00 x 10.4 x 1.61 in) – ABE1200-1T24 / ABE1200-1T48



12.1 OUTLINE DRAWING & CONNECTIONS – U-CHASSIS FORCED AIR COOLING (ABC1200-1T24-UCF)

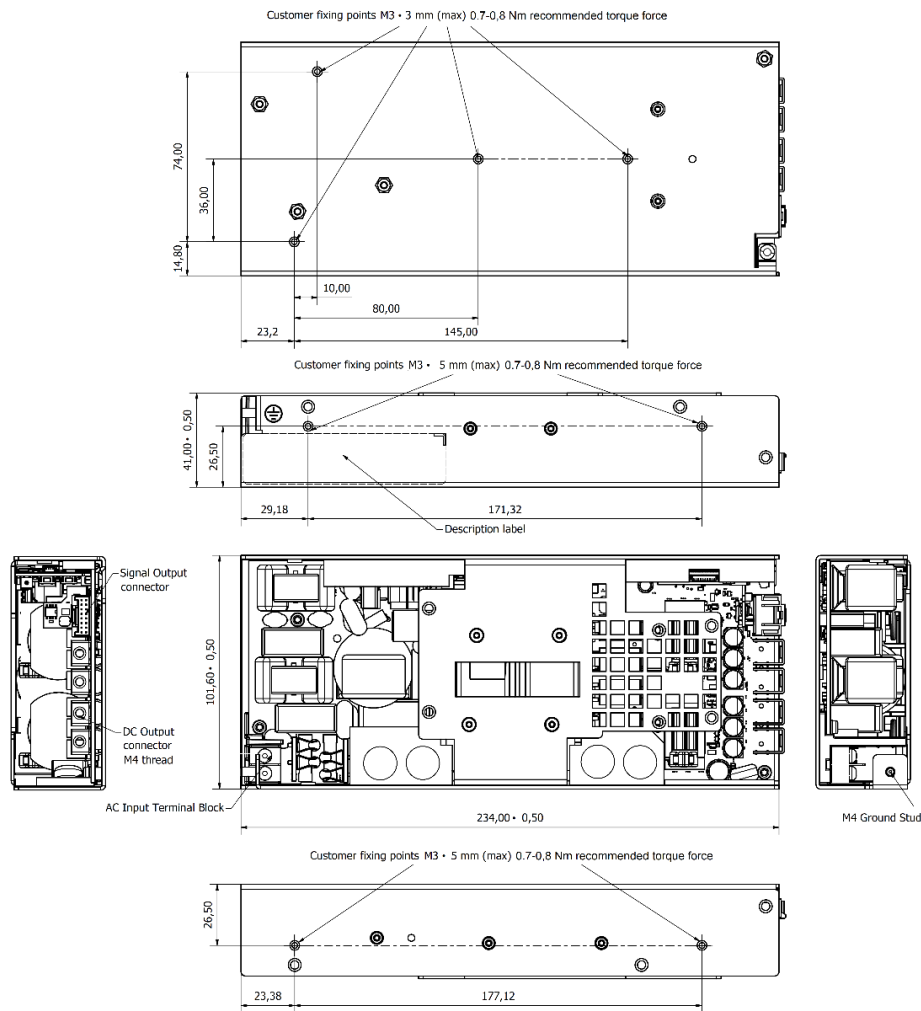

Figure 1. Mechanical Drawing - ABC1200-1T24-UCF Model

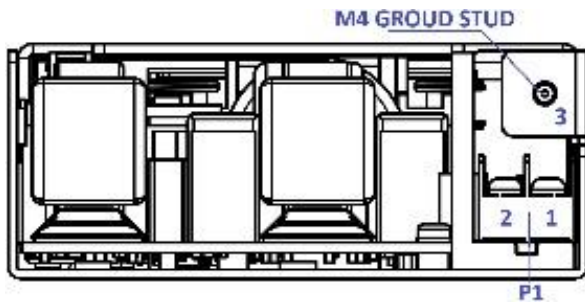

Figure 2. Front View - ABC1200-1T24-UCF Model

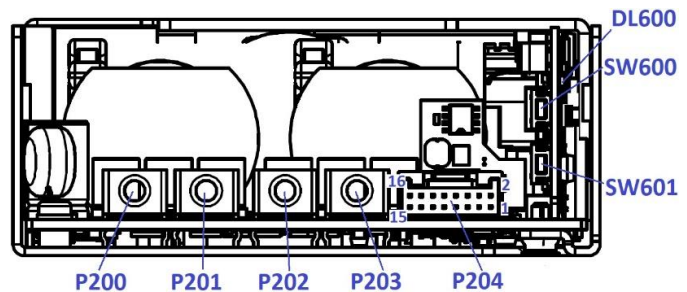

Figure 6. Rear View - ABC1200-1T24-UCF Model



Asia-Pacific
+86 755 298 85888

Europe, Middle East
+353 61 49 8941

North America
+353 61 49 8941

12.2 OUTLINE DRAWING & CONNECTIONS – PERFORATED COVER FORCED AIR COOLING (ABC1200-1T24-PCF)

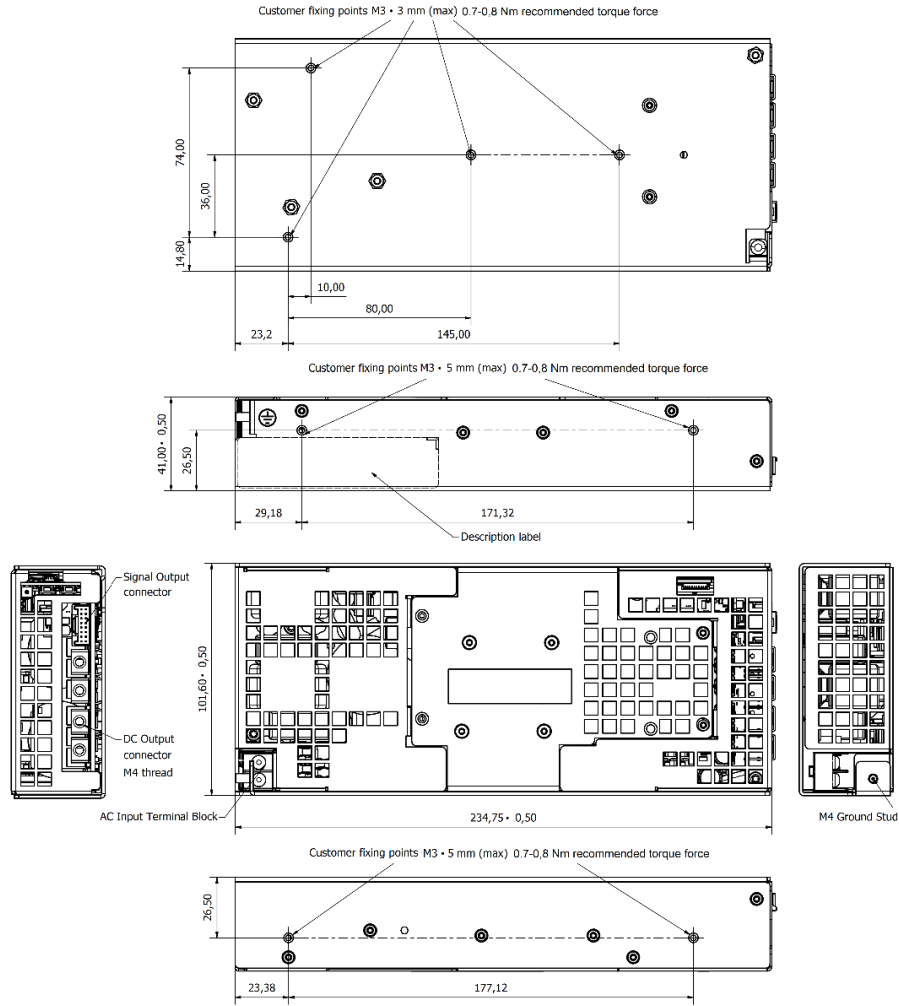

Figure 4. Mechanical Drawing - ABC1200-1T24-PCF Model

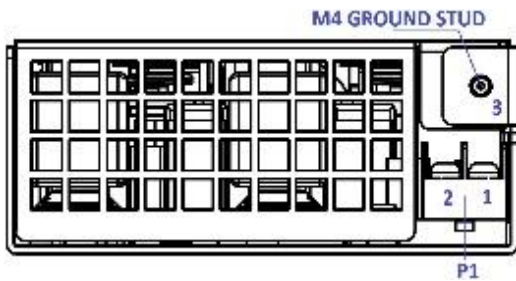

Figure 5. Front View - ABC1200-1T24-PCF Model

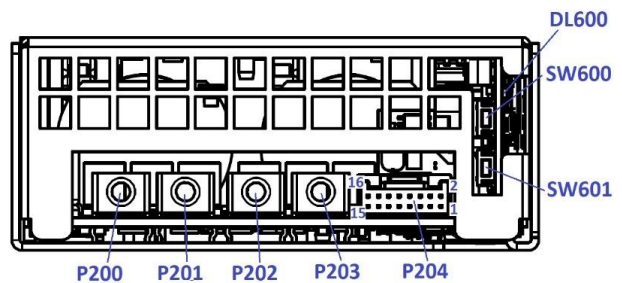

Figure 6. Rear View - ABC1200-1T24-PCF Model

12.3 OUTLINE DRAWING & CONNECTIONS – FRONT MOUNTED FAN (ABE1200-1T24 / ABE1200-1T48)

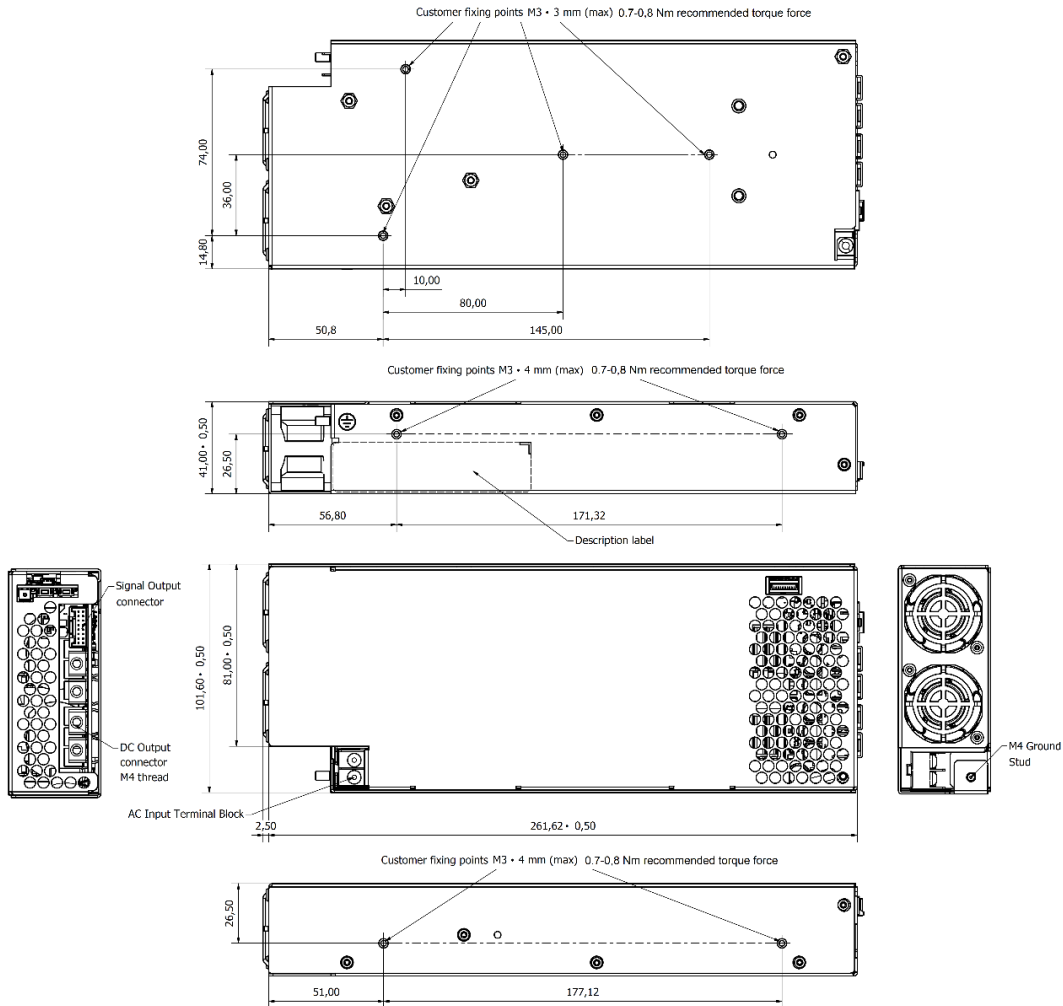

Figure 7. Mechanical Drawing - ABE1200-1T24 / ABE1200-1T48 Models

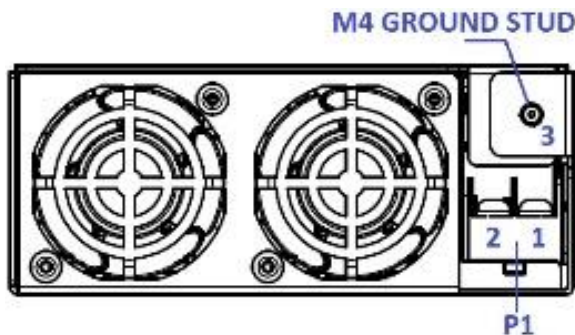

Figure 8. Front View - ABE1200-1T24 / ABE1200-1T48 Models

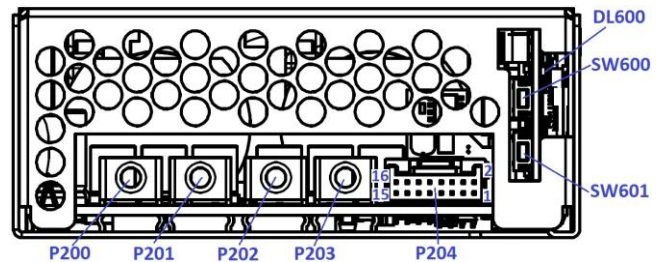
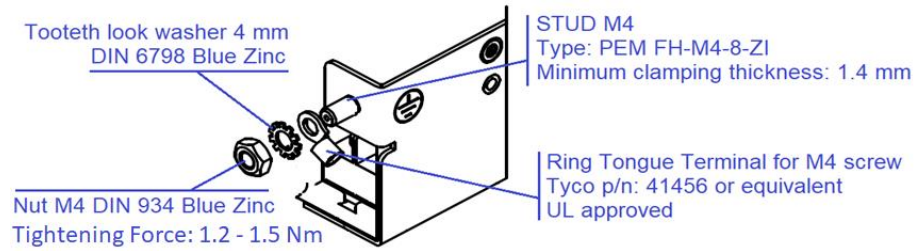

Figure 9. Rear View - ABE1200-1T24 / ABE1200-1T48 Models

12.4 PROTECTION EARTH CONNECTION INSTRUCTIONS



For more information on these products consult: tech.support@psbel.com

NUCLEAR AND MEDICAL APPLICATIONS - Products are not designed or intended for use as critical components in life support systems, equipment used in hazardous environments, or nuclear control systems.

TECHNICAL REVISIONS - The appearance of products, including safety agency certifications pictured on labels, may change depending on the date manufactured. Specifications are subject to change without notice.



tech.support@psbel.com
belfuse.com/power-solutions