

gen4-RP2350-MCU Series



gen4-RP2350-XX (Non-Touch)*

gen4-RP2350-XXT (Resistive Touch)*

gen4-RP2350-XXCT (Capacitive Touch)*

gen4-RP2350-XXCT-CLB (Capacitive Touch w/ CLB)*

* - XX indicates the display size: 24 (2.4"), 28 (2.8"), 32 (3.2") or 35 (3.5")

Datasheet

Revision 1.1

Copyright © 2026 4D Systems

Content may change at any time. Please refer to the resource centre for latest documentation.

Contents

1. Description	4
2. Features	6
3. Hardware Overview	8
4. Hardware Interface - Pins	10
4.1. Serial Ports - 3.3V TTL	10
4.2. I2C Port - 3.3V TTL	10
4.3. SPI Port - 3.3V TTL	11
4.4. General Purpose I/O	12
4.5. System Pins	14
5. Module Features	15
5.1. RP2350B Processor	15
5.2. Chipsets used	15
5.3. SD/SDHC Memory Cards	16
5.4. microSD Socket Usage	17
5.5. FAT16 vs FAT32	17
5.6. BOOTSEL and RESET Buttons	18
6. Display/Module Precautions	19
7. Hardware Tools	20
7.1. gen4-RP2350 Breakout Board	20
7.2. 4D-UPA	21
7.3. USB-C Cable	22
8. Workshop5 IDE	23
8.1. Tools available inside the Workshop IDE	23
9. Programming Language	24
10. Display Module Part Numbers	24
11. Cover Lens Bezel - Tape Spec	25
12. FFC Cable	26

13. Mechanical Details	27
13.1. 2.4" Non-Touch, Resistive Touch and Capacitive Touch	27
13.2. 2.4" Capacitive Touch with CLB	28
13.3. 2.8" Non-Touch, Resistive Touch and Capacitive Touch	29
14. 2.8" Capacitive Touch with CLB	30
15. 3.2" Non-Touch, Resistive Touch and Capacitive Touch	31
16. 3.2" Capacitive Touch with CLB	32
17. 3.5" Non-Touch, Resistive Touch and Capacitive Touch	33
18. 3.5" Capacitive Touch with CLB	34
19. Schematic Circuit Details	35
20. Specifications	36
21. Revision History	40
22. Legal Notice	41
22.1. Proprietary Information	41
22.2. Disclaimer of Warranties & Limitations of Liabilities	41

1. Description

The gen4-RP2350 Series of Intelligent Display Modules, is designed and manufactured by 4D Systems.

These display modules are available in 2.4", 2.8", 3.2" and 3.5", offering an MCU-16 (8080) Interface between the RP2350B Processor, and the TFT LCD Displays. The 2.4", 2.8" and 3.5" displays are IPS TFT LCD's, and the 3.2" is a TN TFT LCD.

Available in Non-Touch, Resistive Touch, Capacitive Touch, and Capacitive Touch with Cover Lens Bezel (CLB).

The RP2350B Processor makes available multiple GPIO which include UART, SPI, I2C, PWM and Analog functionality, while also serving interfaces for the LCD Touch screen, Quad SPI Flash, microSD Card, and Native USB-C.

The user interface to the gen4-RP2350 series is a 30-pin FPC/ZIF socket, designed for a 30-way 0.5mm pitch FFC cable, for easy and simple connection to an application or motherboard, or for connecting to accessory boards for a range of functionality advancements.

This series of boards is compatible with the 4D Systems Workshop5 IDE, utilising the Raspberry Pi Pico SDK and 4D Systems purpose built libraries, allowing a feature rich design and programming experience.

Any code designed and written to run on other 4D Systems display modules, such as modules featuring Goldelox, Picaso, Pixxi or Diablo16 Graphics Processors, are unfortunately not compatible with the gen4-RP2350 range due to being a totally different processor family. However, please contact 4D Systems Support Team for assistance if you are planning on migrating from a different 4D Systems display model, as there are some similarities between them - such as the graphics, however a majority of the coding will have to be adapted.

From a mechanical perspective, these gen4-RP2350 modules are physically the same mounting size as other gen4 products by 4D Systems. The only difference is the circuitry used. Overall thickness of these gen4-RP2350 modules are greater than other gen4 products, due to the USB-C connector. Typically, where ever a different gen4 module had been mounted, a gen4-RP2350 module could fit in the same location.

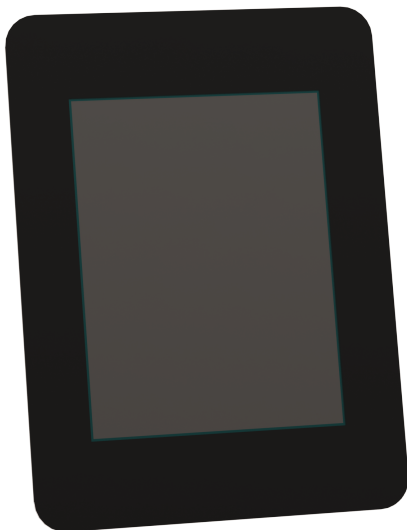

gen4-RP2350-32CT-CLB Front

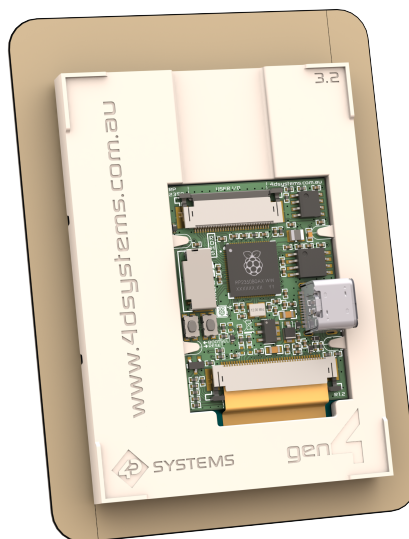

gen4-RP2350-32CT-CLB Rear



gen4-RP2350-32CT Front

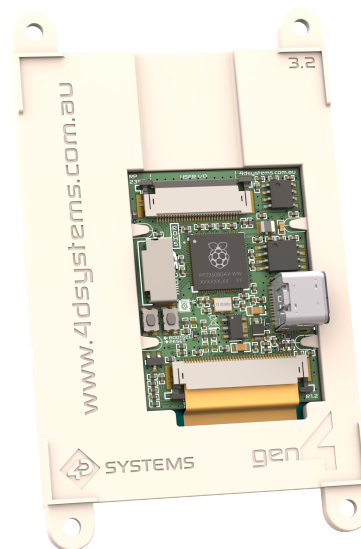

gen4-RP2350-32CT Rear

2. Features

- Powerful RP2350B Processor by Raspberry Pi.
- 240x320 resolution displays for 2.4", 2.8", and 3.2", while a 320x480 resolution display for 3.5", utilising RGB565 colours.
- IPS TFT LCD display for 2.4", 2.8" and 3.5" and TN TFT LCD display for 3.2".
- Available in Non-Touch, Capacitive Touch, and Capacitive Touch with Cover Lens Bezel (CLB).
- 520 KiB (520 × 1024 bytes) of on-chip SRAM.
- 16MB of External Quad SPI Flash.
- 8MB of External Quad SPI PSRAM.
- 16 Configurable GPIO all able to of digital input and output or the following:
 - 5 GPIO capable of ADC (analog read)
 - Capable of UART (up to 2 Channels)
 - Capable of SPI (up to 2 Channels)
 - Capable of I2C (up to 2 Channels, 1 of which is utilized when using CTP variants)
 - and other RP2350 supported IO functions.
- 30pin FPC connection, for all signals, power, communications, and GPIO.
- Push/Pull micro-SD memory card connector for multimedia storage and data logging purposes.
- Display full colour images, animations, icons and video clips.
- 4.0V to 6.0V range operation (single supply).
- 4x mounting tabs with 3.2mm holes for mechanical mounting using M3 screws (non CLB models only).
- 3M Adhesive around perimeter of Cover Lens Bezel for mounting the CTP-CLB model.
- RoHS and REACH compliant.
- CE/EMC and UKCA compliance pending.
- PCB is UL 94V-0 Flammability Rated.

- Module dimensions:

- (2.4" Non-Touch): 78.4 x 44.8 x 11.3mm
- (2.4" Resistive Touch): 78.4 x 44.8 x 12.5mm
- (2.4" Capacitive Touch): 78.4 x 44.8 x 12.4mm
- (2.4" Capacitive Touch w/ CLB): 79.0 x 58.7 x 12.4mm
- (2.8" Non-Touch): 87.3 x 52.1 x 11.5mm
- (2.8" Resistive Touch): 87.3 x 52.1 x 12.7mm
- (2.8" Capacitive Touch): 87.3 x 52.1 x 12.6mm
- (2.8" Capacitive Touch w/ CLB): 87.6 x 67.2 x 12.6mm
- (3.2" Non-Touch): 95.7 x 57.14 x 11.7mm
- (3.2" Resistive Touch): 95.7 x 57.1 x 12.9mm
- (3.2" Capacitive Touch): 95.7 x 57.1 x 13.6mm
- (3.2" Capacitive Touch w/ CLB): 98.8 x 72.6 x 13.6mm
- (3.5" Non-Touch): 101.1 x 56.6 x 11.2mm
- (3.5" Resistive Touch): 101.1 x 56.6 x 12.4mm
- (3.5" Capacitive Touch): 101.1 x 56.6 x 13.1mm
- (3.5" Capacitive Touch w/ CLB): 104.2 x 72.1 x 13.1mm

- Weighing (approximately):

- (2.4" Non-Touch): ~ 21g
- (2.4" Resistive Touch): ~ 26g
- (2.4" Capacitive Touch): ~ 26g
- (2.4" Capacitive Touch w/ CLB): ~ 30g
- (2.8" Non-Touch): ~ 29g
- (2.8" Resistive Touch): ~ 34g
- (2.8" Capacitive Touch): ~ 36g
- (2.8" Capacitive Touch w/ CLB): ~ 41g
- (3.2" Non-Touch): ~ 32g
- (3.2" Resistive Touch): ~ 46g
- (3.2" Capacitive Touch): ~ 48g
- (3.2" Capacitive Touch w/ CLB): ~ 54g
- (3.5" Non-Touch): ~ 37g
- (3.5" Resistive Touch): ~ 47g
- (3.5" Capacitive Touch): ~ 47g
- (3.5" Capacitive Touch w/ CLB): ~ 54g

3. Hardware Overview

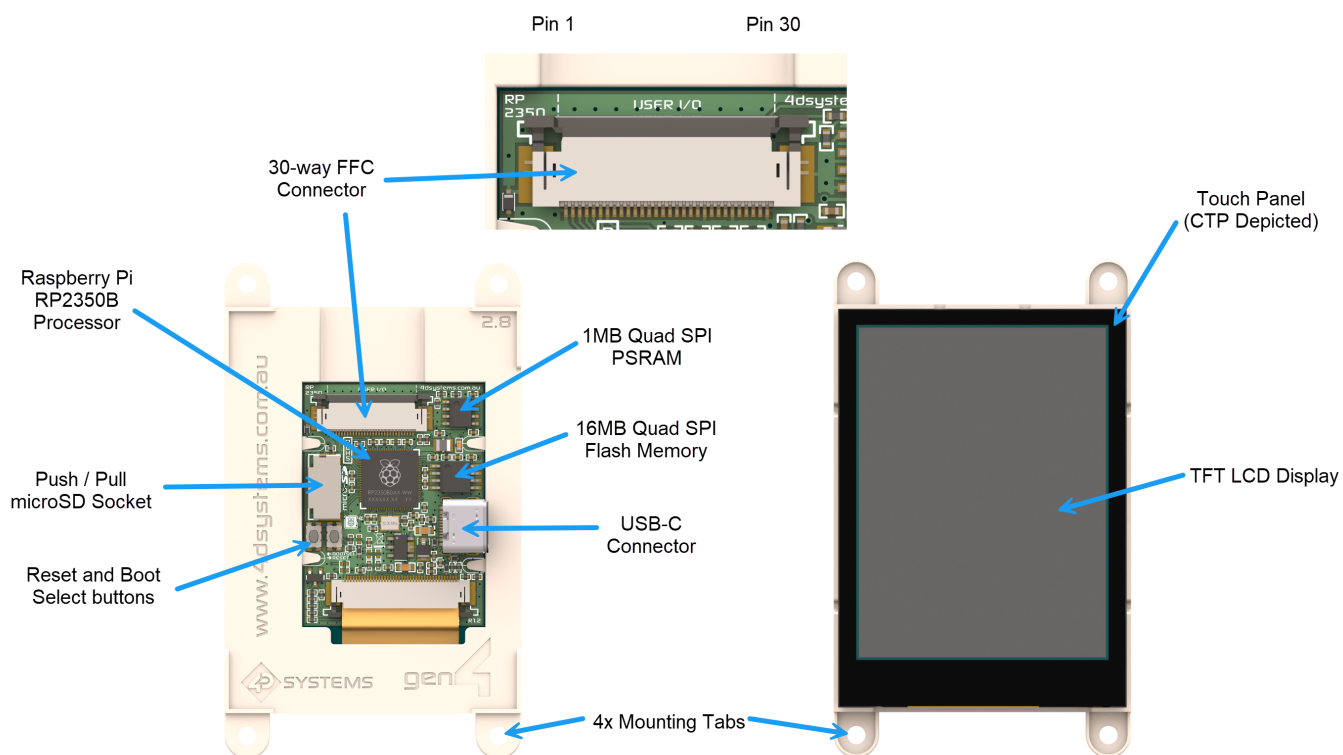

Hardware Layout (2.8" CTP Module depicted)

Pin	Symbol	I/O	Description
1	GND	P	Supply Ground
2	GPI016	I/O	General Purpose Input/Output pin, 3.3V logic
3	GPI09	I/O	General Purpose Input/Output pin, 3.3V logic
4	GPI08	I/O	General Purpose Input/Output pin, 3.3V logic
5	GPI07	I/O	General Purpose Input/Output pin, 3.3V logic
6	GPI06	I/O	General Purpose Input/Output pin, 3.3V logic
7	GPI03	I/O	General Purpose Input/Output pin, 3.3V logic
8	GPI02	I/O	General Purpose Input/Output pin, 3.3V logic
9	GPI01	I/O	General Purpose Input/Output pin, 3.3V logic
10	GPI040	I/O	General Purpose Input/Output pin, 3.3V logic
11	GPI041	I/O/A	General Purpose Input/Output pin capable of Analog, 3.3V logic
12	GPI042	I/O/A	General Purpose Input/Output pin capable of Analog, 3.3V logic
13	GPI043	I/O/A	General Purpose Input/Output pin capable of Analog, 3.3V logic
14	GPI044	I/O/A	General Purpose Input/Output pin capable of Analog, 3.3V logic
15	GPI045	I/O/A	General Purpose Input/Output pin capable of Analog, 3.3V logic
16	SPARE1	-	Not connected
17	SPARE2	-	Not connected
18	SWCLK	I	Access to the internal Serial Wire Debug multi-drop bus. Provides debug access to both processors, and can be used to download code.

Pin	Symbol	I/O	Description
19	SWD	I/O	Access to the internal Serial Wire Debug multi-drop bus. Provides debug access to both processors, and can be used to download code.
20	3.3V	P	3.3V Output for User, connected to system 3.3V bus. Excessive draw will affect system stability. 100mA-200mA draw should be OK
21	GND	P	Supply Ground
22	RUN/RESET	I	Master Reset/Enable signal. Low will disable the chip, High will activate the chip.
23	UART-RX1	I	Asynchronous Serial Receive pin, 3.3V TTL level. Connect this pin to the Transmit (Tx) signal of other serial devices. This pin is 3.3V Logic only. (GPIO5)
24	UART-TX1	O	Asynchronous Serial Transmit pin, 3.3V TTL level. Connect this pin to the Receive (Rx) signal of other serial devices. This pin is 3.3V Logic only. (GPIO4)
25	GND	P	Supply Ground
26	5V IN	P	Main Voltage Supply +ve input pin. Reverse polarity protected. The range is 4.0V to 6.0V, nominal 5.0V.
27	5V IN	P	Main Voltage Supply +ve input pin. Reverse polarity protected. The range is 4.0V to 6.0V, nominal 5.0V.
28	5V IN	P	Main Voltage Supply +ve input pin. Reverse polarity protected. The range is 4.0V to 6.0V, nominal 5.0V.
29	5V IN	P	Main Voltage Supply +ve input pin. Reverse polarity protected. The range is 4.0V to 6.0V, nominal 5.0V.
30	GND	P	Supply Ground

Note

1. **I** = Input, **O** = Output, **P** = Power, **A** = Analog Input
2. It is recommended to connect 2 or more 5V IN pins to a stable 5V DC power supply, as well as 2 or more GND pins.
3. Please refer to the [Raspberry Pi RP2350B datasheet](#) for specific detail on the capability of the RP2350 GPIO, in conjunction with the schematic of this module.

4. Hardware Interface - Pins

This section describes in detail the hardware interface pins of the module.

4.1. Serial Ports - 3.3V TTL

The gen4-RP2350 Series is configured to use the GPIO5 (RX) and GPIO4 (TX) as the default UART pins. These pins are broken out to the 30-way FFC connector through pins 23 and 24. This configuration uses **UART1** of the RP2350B. However, it is possible to utilize other pins for UART1. Depending on pin availability, an additional UART bus can also be configured by utilizing **UART0**.

CTS and RTS pins can also be configured to work with the TX and RX pins. For instance, when using the default UART TX (GPIO4) and RX (GPIO5) in **UART1**, GPIO6 and GPIO7 can be used as CTS and RTS pins respectively. Other pins may be used as well as long as they share the same UART instance.

Please refer to the [Raspberry Pi RP2350 Datasheet](#) for more details.

4.2. I2C Port - 3.3V TTL

The gen4-RP2350 Series is configured to use GPIO9 (SCL) and GPIO8 (SDA) as the default I2C pins. These pins are broken out to the 30-way FFC connector through pins 3 and 4. External pull-up resistors may be required. This configuration uses **I2C0** of the RP2350B.

It is not required to stick to this configuration. Other pins broken out of the 30-way interface can be used as alternative I2C pins.

Please refer to the [Raspberry Pi RP2350 Datasheet](#) for more details.

Note

When using capacitive touch variants of this series, **I2C1** is being used to communicate with the touch chip. Therefore, the pins broken out of the 30-way interface and capable of I2C1 may not be used in this configuration. However, it is perfectly fine when using non-touch and resistive variants.

4.3. SPI Port - 3.3V TTL

The gen4-RP2350 Series is configured to use the following pins as the default SPI bus:

Pin	Function
GPI042	SCK
GPI043	TX
GPI044	RX
GPI045	CSn

These pins are broken out to the 30-way FFC connector through pins 12 to 15. This configuration uses **SPI1** of the RP2350B.

It is not required to stick to this configuration. Other pins broken out of the 30-way interface can be used as alternative SPI pins.

Please refer to the [Raspberry Pi RP2350 Datasheet](#) for more details.

4.4. General Purpose I/O

There are 16 general-purpose Input/Output (GPIO) pins available to the user. Many of these can be configured to be SPI, I2C and UART, amongst other configurations. Please refer to the [Raspberry Pi RP2350 datasheet](#) for more specific information.

GPIO	Digital Input	Digital Output	Analog Read	SPI	I2C	PWM	UART
GPIO1	Yes	Yes		CSn0	SCL0	PWM0 B	RX0
GPIO2	Yes	Yes		SCK0	SDA1	PWM1 A	CTS0 / TX0
GPIO3	Yes	Yes		TX0	SCL1	PWM1 B	RTS0 / RX0
GPIO4	Yes	Yes		RX0	SDA0	PWM2 A	TX1*
GPIO5	Yes	Yes		CSn0	SCL0	PWM2 B	RX1*
GPIO6	Yes	Yes		SCK0	SDA1	PWM3 A	CTS1 / TX1
GPIO7	Yes	Yes		TX0	SCL1	PWM3 B	RTS1 / RX1
GPIO8	Yes	Yes		RX1	SDA0*	PWM4 A	TX1
GPIO9	Yes	Yes		CSn1	SCL0*	PWM4 B	RX1
GPIO16	Yes	Yes		RX0	SDA0	PWM0 A	TX0
GPIO40	Yes	Yes		RX1	SDA0	PWM8 A	TX1
GPIO41	Yes	Yes	Yes	CSn1	SCL0	PWM8 B	RX1
GPIO42	Yes	Yes	Yes	SCK1*	SDA1	PWM9 A	CTS1 / TX1
GPIO43	Yes	Yes	Yes	TX1*	SCL1	PWM9 B	RTS1 / RX1
GPIO44	Yes	Yes	Yes	RX1*	SDA0	PWM10 A	TX0
GPIO45	Yes	Yes	Yes	CSn1*	SCL0	PWM10 B	RX0

1. Functions marked with * are default configuration specified for the boards configuration in the Pico SDK.
2. All pins broken out of the FFC interface is capable of PIO. However, please note that the LCD requires to use PIO. The uSD interface on the other hand is recommended to utilize PIO for SDIO but may also be interfaced through SPI. When using the Graphics4D library, both the LCD interface and the SD card utilizes PIO.

Please refer to the [Raspberry Pi RP2350 datasheet](#) for complete GPIO capabilities and [Pico SDK documentation](#) for information on how to configure the GPIO for various functions: digital input and output, analog input, I2C, UART and SPI, etc.

GPIO1 to GPIO9, and GPIO16

General purpose I/O pin, capable of Digital Input and Output. This pin is 3.3V tolerant only and 3.3V logic level. Can be configured for additional functionality such as SPI, I2C, UART etc. - please refer to the [Pico SDK documentation](#).

GPIO40 to GPIO45

General purpose I/O pin, capable of Digital Input and Output, along with Analog Input. This pin is 3.3V tolerant only and 3.3V logic level. Can be configured for additional functionality such as SPI, I2C, UART etc. - please refer to the [Pico SDK documentation](#).

4.5. System Pins

5V IN (Module Voltage Input):

Module supply voltage input pins. At least two (however ideally four) of these pins should be connected to a stable supply voltage in the range of 4.0 Volts to 5.5 Volts DC. Nominal operating voltage is 5.0 Volts. Utilising 4 pins shares the current over the FFC cable, which is important for the larger size displays.

GND (Module Ground):

Device ground pins. At least two (ideally four) pins should be connected to the ground.

RUN/RESET (Module Run/Reset):

Pulling this pin to 0V will disable the module, and put it into a reset state. Pulling the pin High or floating (due to build in pull-up resistor) will enable the module.

5. Module Features

The gen4-RP2350 Series is designed to accommodate a wide variety of applications. Some of the main features of the module are listed below.

5.1. RP2350B Processor

The module is designed around the RP2350B Processor from Raspberry Pi. This model of RP2350 has 48 GPIO in total, most of which are used to connected to the display and microSD. The rest of the pins are broken out of the modules FFC interface for the user.

The RP2350 chip doesn't have an internal flash and is instead connected to an external 16MB Quad SPI Flash for application storage. It features 520 KiB (520 x 1024 bytes) on-chip SRAM and a 8MB external Quad SPI PSRAM. Both the external Flash and PSRAM are connected via the XIP interface with the PSRAM utilizing **GPIO0** for XIP CS1 pin.

Media is typically stored on a micro-SD card, however some types of media can be stored in SPI Flash, however it is very limited for capacity.

5.2. Chipsets used

The gen4-RP2350 Series of modules utilises a few chipsets from various manufacturers, in order for these modules to operate. Please refer to the Schematic for connection details.

- The main processor is an Raspberry Pi RP2350B, as mentioned in the previous section.
- For Capacitive Touch models, the chipset for the capacitive touch is I2C driven, and the chipset is found on the Display flex itself. These utilise Focaltech controllers for 2.4", 2.8", 3.2" and 3.5" models.
- The Quad SPI Flash memory used on these modules, is the Winbond W25Q128JVS1Q, which is 16MB in capacity, and interfaces to the RP2350B on the same Quad SPI bus as the PSRAM.
- The Quad SPI PSRAM used on these modules, is a AP Memory APS6404L-3SQR-SN, which is 8MB in capacity, and interfaces to the RP2350B on the same Quad SPI bus as the Flash memory.
- The micro-SD card interface, while not a chipset, is still worthy of note. It utilises several GPIO pins from the RP2350 serving as an SDIO bus through PIO. The micro-SD cards can also be used with SPI but is much slower but frees up extra PIO.

5.3. SD/SDHC Memory Cards

The gen4-RP2350 modules use off-the-shelf standard SDHC/SD/microSD memory cards with up to 4GB capacity usable with FAT16 formatting, and much higher with FAT32 formatting. For any FAT file-related operations, before the memory card can be used it must first be formatted. The formatting of the card can be done on any PC system with a card reader.

Cards with a FAT16 formatting (4GB or under partition) are capable of operating faster on this display module, compared to the same card (16GB for example) with a single FAT32 partition, due to the nature of FAT16 vs FAT32 file transfers. If your application media can fit inside a 4GB partition, it is recommended to use FAT16 to gain the maximal speed possible.

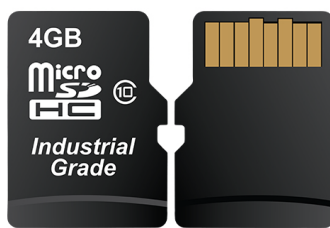

RMPET, a 4D Systems Tool found in the Workshop5 IDE, is capable of repartitioning and formatting microSD cards for FAT16, to be the appropriate type and format. This tool should be used for all cards as it also employs an offset which is critical when using Industrial microSD cards which feature Read Disturb Prevention firmware, which is a special firmware inside the microSD card designed to prevent Read Disturb occurring on NAND based Flash media. Further, discussed in the note.

Note

1. An SPI Compatible SDHC/SD/microSD card MUST be used when operating in SPI mode instead of SDIO via PIO. If a non-SPI compatible SD card is used, then the processor should utilize PIO to behave as an SDIO interface.
2. Read disturbance is a well-known issue with flash memory devices, such as microSD cards, where reading data from a flash cell can cause the nearby cells in the same memory block to change over time. This issue can be prevented by using industrial-grade microSD cards with read disturb protection. Industrial-grade microSD cards have firmware that actively monitors the read operation and refreshes areas of memory that have high traffic and even move data around to prevent read disturb error from occurring. Furthermore, manufacturers may choose to implement read disturb protection on a specific part of the flash memory only, such that the beginning part of the memory might not be protected. The RMPET utility in Workshop is designed to create the first partition at an offset from the start of the microSD card to account for this situation. It is therefore recommended to always partition and format an industrial microSD card using the RMPET utility before using it with 4D Systems modules. Many commercial grade cards designed for Cameras etc, do not handle read disturb well at all, and therefore it is always recommended to use an Industrial grade microSD card with 4D modules. 4D offers one that is tried and tested, on our website.

5.4. microSD Socket Usage

On the 2.4" to 3.5" gen4-RP2350 modules is a Push-Pull microSD socket. The microSD card sits above the component level. To use this socket is simple if you follow these easy steps.

- Position the microSD card in line with the microSD socket, above the components.
- Push the microSD card into the socket, until it slides all the way in.

Please refer to the following diagram for guidance:

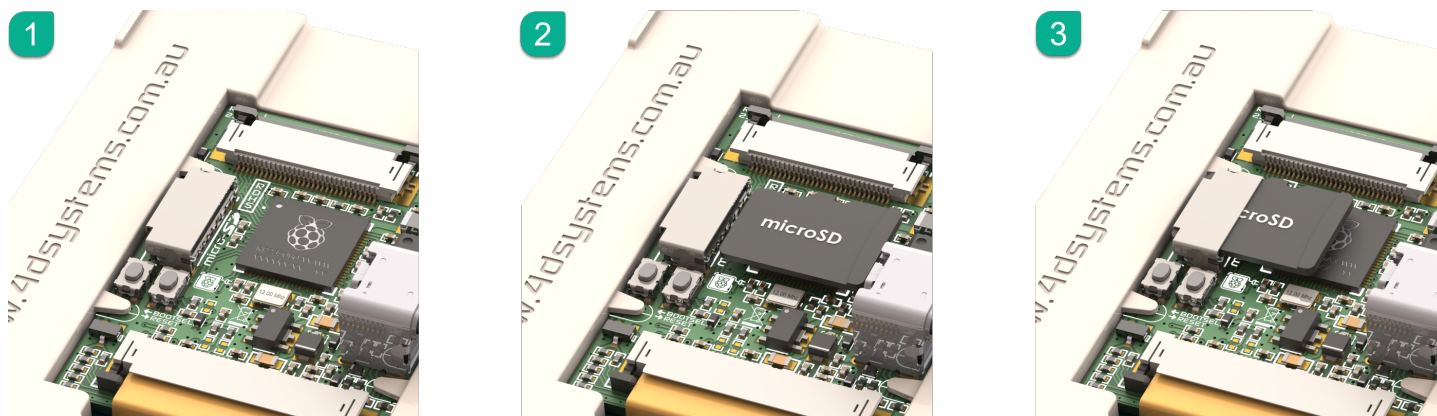

5.5. FAT16 vs FAT32

FAT16 is capable of having a partition with up to 4GB capacity usable. While this might seem like a limitation, it still offers the best performance for small processor systems such as the RP2350. Larger partitions are possible with FAT32 formatting, however smaller cluster size results, giving slightly worse performance.

For any FAT file-related operations, before the memory card can be used it must first be formatted correctly. Built into Workshop5 is a tool created by 4D, called RMPET (please refer to the Tools menu, inside the Workshop5 IDE). RMPET allows the User to easily partition and format microSD cards, to make their file system ready to be used with 4D Systems modules. The formatting of the card can be done on any Windows PC system with a card reader.

5.6. BOOTSEL and RESET Buttons

The gen4-RP2350 series of display modules features two onboard buttons that allow manually resetting to bootloader mode. This allows the display module to be easily programmable by copying **UF2** files to the USB drive that appears while in bootloader mode.

To reset into bootloader mode, perform the following:

1. Press and hold the BOOTSEL button.
2. Briefly press the RESET button to reset the display.
3. Release the BOOTSEL button.

Typically, one doesn't always need to manually trigger bootloader mode using these buttons. It is possible to reset the display into bootloader mode when USB Serial is set up in the last project uploaded to it. Workshop5 IDE uses this feature to effectively upload programs to the display without the user having to manually putting it to bootloader mode.

For more information regarding programming the gen4-RP2350 modules using Workshop5, please refer to [Workshop5 RP2350 Environment Manual](#)

6. Display/Module Precautions

- Avoid having to display the same image/object on the screen for lengthy periods. This can cause a burn-in which is a common problem with all types of display technologies. Blank the screen after a while or dim it very low by adjusting the contrast. Better still; implement a screen saver feature.
- Moisture and water can damage the display. Moisture on the surface of a powered display should not cause any problems, however, if water is to enter the display either from the front or from the rear, or come in contact with the PCB, it will damage. Wipe off any moisture gently or let the display dry before usage. If using this display module in an environment where it can get wet, ensure an appropriate enclosure is used.
- Dirt from fingerprint oil and fat can easily stain the surface of the display. Gently wipe off any stains with a soft lint-free cloth.
- The performance of the display will degrade under high temperatures and humidity. Avoid such conditions when storing.
- Do not tamper with the display flex cable that is connected to the control board. This may affect the connection between the display and the driving circuitry and cause failure.
- Displays are susceptible to mechanical shock and any force exerted on the module may result in deformed zebra stripes, a cracked display cell and a broken backlight.
- Always use the mounting holes on the module's to mount the display where possible, or mount using the CLB for CLB based modules.
- Display modules have a finite life, which is typically dictated by the display itself, more specifically the backlight. The backlight contains LEDs, which fade over time. In the [Specifications section](#) is a figure for the typical life of the display, and the criteria are listed. The resistive Touch model features a touch-sensitive film over the display which is sensitive to pressure. When mounting the display module in an enclosure, you should not apply pressure to the surface of the display by the enclosure. It could result in false touches or the touch will simply not function at all.

7. Hardware Tools

The following hardware tools are required for full control of the gen4-RP2350 Display Modules.

7.1. gen4-RP2350 Breakout Board

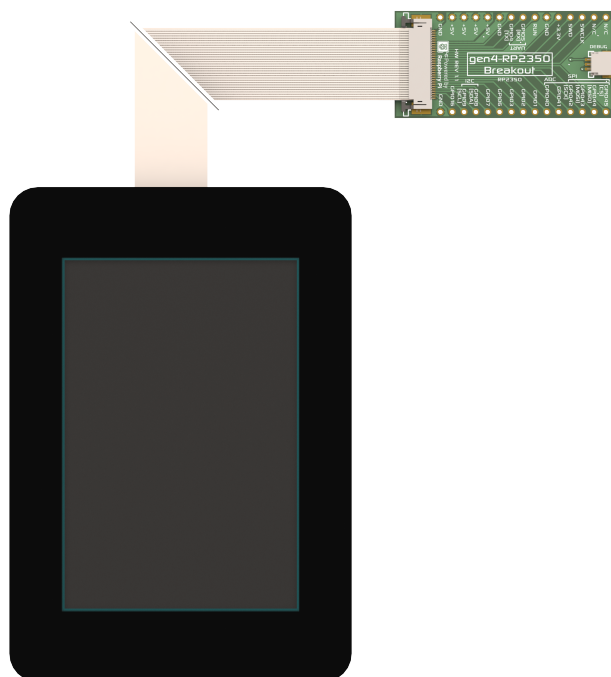

gen4-RP2350 Breakout Front

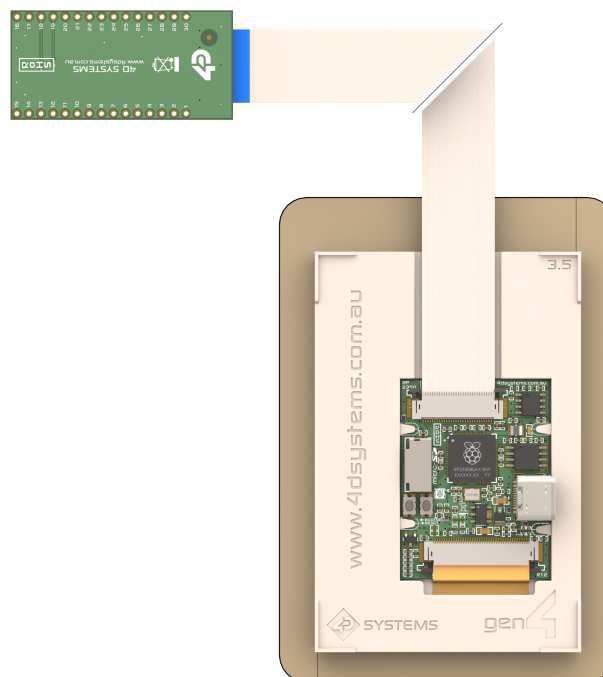

gen4-RP2350 Breakout Back

The gen4-RP2350 Breakout provides easy access to the pins broken out of the 30-way FFC. The board is designed to be compatible with breadboards making it perfect for prototyping.

It also provides direct access to the Serial Wire Debug (SWD) port both through JST connection or through the signals broken out of the sides, making it compatible with **Raspberry Pi Debug Probe**. In addition to this, the default UART pins are also marked making it easy to connect the UART pins of the debug probe for simple UART debugging. The default I2C and SPI pins are also labeled for ease of use.

The diagrams shown above serves as a reference showing how the 30-way FFC cable connects to the gen4-RP2350 module and the breakout board. The connectors on both the RP2350 module, and the breakout board, are Top-Contact, meaning the FFC cable pins should be facing upwards, and the blue stiffener, should be facing down towards the PCB.

The gen4-RP2350 Breakout and FFC cable are available for purchase as additional accessories along with the display.

Note

If using the gen4-RP2350 breakout, only the FFC cable supplied by 4D Systems (or same type) can be used. The type of cable supplied, as described in the [FFC Cable](#) section, is an Opposite type (contacts on opposite sides to each other at end end). If a straight cable (contacts on the same side at both ends) is sourced, this will NOT work when connecting to the gen4-RP2350 breakout, as the connections will be swapped. Please refer to the information provided for more detail.

7.2. 4D-UPA

The 4D-UPA is **NOT** designed to be able to upload applications to the gen4-RP2350 modules. However, it can be used to as a simple UART debugger and breakout the GPIO of RP2350 at the same time. This can be useful for development and testing or final product use in cases where another host needs to communicate with the display using USB connection but needs to keep the main USB-C port for programming.

The GPIO naming convention on the 4D-UPA does not reflect the GPIO naming of the actual display module, due to the 4D-UPA being universal and able to be used with many 4D Products. Please review the 4D-UPA schematic diagram for information on mapping the GPIO naming from this module, with the GPIO naming on the 4D-UPA, to ensure you connect to the correct pins you desire.

4D-UPA is **NOT** required for programming the gen4-RP2350 series of modules, as they have USB-C on board. It is only suitable for simple UART debugging and specific use cases as mentioned previously.

The connectors on both the RP2350 module, and the 4D-UPA, are Top-Contact, meaning the FFC cable pins should be facing upwards, and the blue stiffener, should be facing down towards the PCB.

Note

If using the 4D-UPA, only the supplied FFC cable (or same type) can be used. The type of cable supplied, as described in the [FFC Cable](#) section, is an Opposite type (contacts on opposite sides to each other at end end). If a straight cable (contacts on the same side at both ends) is sourced, this will NOT work when connecting to the 4D-UPA, as the connections will be swapped. Please refer to the information provided for more detail.

7.3. USB-C Cable

A USB-C Cable is the primary way to program a gen4-RP2350 module from 4D Systems, as described previously.

A USB-C cable is not supplied with the modules, as they can be sourced from any computer or hardware store, and come with most Cell Phones these days too.

Connection of the USB-C cable to the module is simple, and simply plugs into the USB-C connector on the board, clearing the gen4 plastics on the side.

The USB-C provides power as well as USB Data communications while developing software on the module and programming it. The USB-C cable can be used in the end product use if desired, or the use of the FFC-Cable directly to the projects main Application PCB as an alternative.

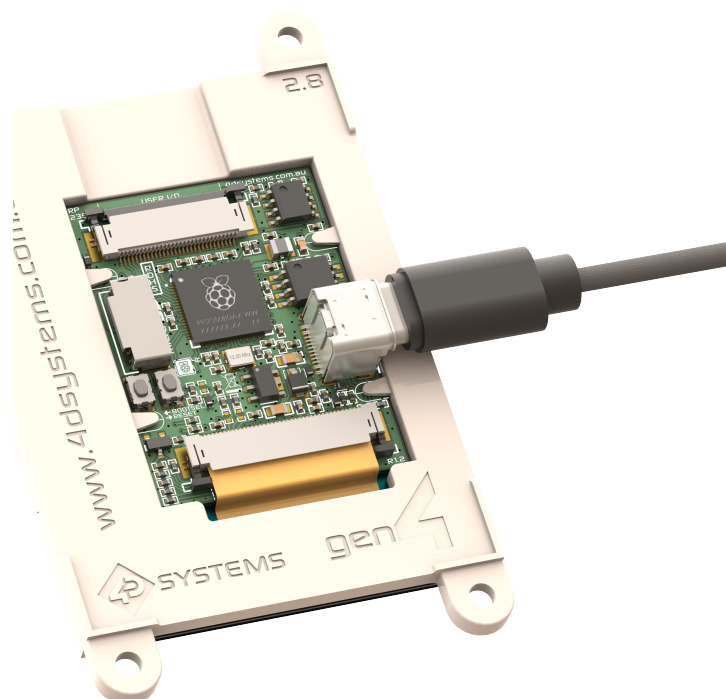

USB-C Connection

8. Workshop5 IDE

Workshop5 is a new comprehensive software IDE, designed based on Workshop4, that provides an integrated software development platform for all the 4D family of processors and modules, as well as some 3rd party processors such as the Raspberry Pi RP2350.

The IDE provides a code editor and WYSIWYG design area for gen4-RP2350 based modules, to develop complete application code with various widgets and media references as required.

All user application code can be developed within the Workshop5 IDE, and is easily coupled with graphics and media, so it can be a one-stop shop for development with these modules.

The Workshop5 IDE utilises the Pico SDK to handle the compiling, linking and downloading of RP2350 based projects, without having to interface with any separate application at all.

For experienced users who may prefer or need to use some features that other software provides, Workshop5 provides a way to export the project to a simple standalone project that can be opened in VS Code or similar applications allowing users to continue their development in their preferred software tools.

Note

Pico SDK needs to be installed together with all its dependencies before Workshop5 can compile and upload projects. These are not included when installing Workshop5 and must be installed separately using the [pico-setup-windows installer](#).

For complete development setup instructions, please refer to the [Workshop5 RP2350 Development Manual](#)

8.1. Tools available inside the Workshop IDE

Built into Workshop5 are a number of tools which are available to aid the programming of the gen4-RP2350 series of displays.

Terminal, as the name implies, is a terminal application that can be used to communicate with the display module and is primarily used for basic debugging. It displays incoming Serial messages from the display module in ASCII and HEX format. It is capable of sending character or hex strings as well as keystrokes to the display.

RMPET is a partitioning and formatting tool, used to correctly set up a micro-SD card for use with 4D Systems products. This is further discussed in the [SD/SDHC Memory Cards section](#)

9. Programming Language

The programming language used in the Workshop5 IDE to program the gen4-RP2350 series of modules, is C++. It simplifies microcontroller coding, bridging the gap between users and hardware. Its approachability and community support make it ideal for various projects.

10. Display Module Part Numbers

The following is a breakdown of the part numbers and what they mean.

Example:

- gen4-RP2350-24
- gen4-RP2350-28T
- gen4-RP2350-32CT
- gen4-RP2350-35CT-CLB

where:

```
gen4    - gen4 Display Range
RP2350  - RP2350 Display Family
24      - Display size (2.4")
28      - Display size (2.8")
32      - Display size (3.2")
35      - Display size (3.5")
T       - Resistive Touch
CT      - Capacitive Touch
CLB     - Cover Lens Bezel
```

Note

- A product without a T or CT in the part number is a non-touch variant.
- Cover Lens Bezels (CLB) are glass fronts for the display module with overhanging edges, which allow the display module to be mounted directly into a panel using special adhesive on the overhanging glass. This is available for capacitive touch only.

11. Cover Lens Bezel - Tape Spec

The perimeter of the CLB display modules features double-sided adhesive tape, designed to stick directly onto a panel, enclosure, box etc. without the need for any mounting screws or hardware.

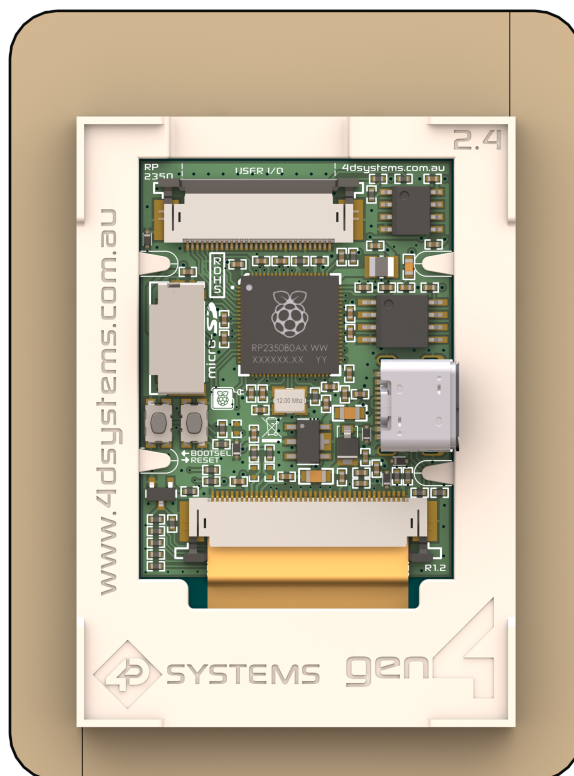

The tape used is 3M 9495LE tape, which uses well-known and strong 3M 300LSE adhesives. The double-sided adhesive has a thickness of 0.17mm once the backing has been removed.

More information on this adhesive can be found on the 3M website.

12. FFC Cable

The FFC cables supplied by 4D Systems have the following specifications:

- **30 Pin** Flexible Flat Cable, 150mm Long, 0.5mm (0.02") pitch
- Cable Type: AWM 20624 80C 60V VW-1
- Heat Resistance 80 Degrees Celsius
- Connections on the opposite side at each end (Type B)

You can get different cable lengths from the 4D Systems website.

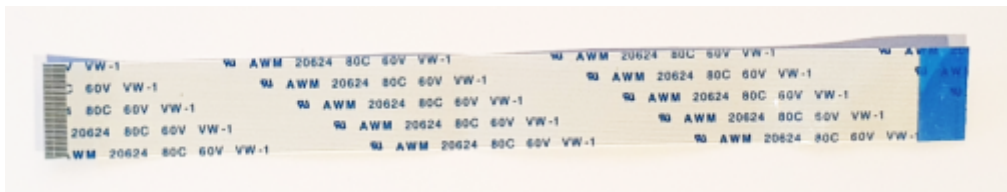

Note

If you are interfacing with this module directly to your product via the 30-way FFC rather than utilising a breakout board or 4D-UPA, suitable connectors are readily available from many electronics suppliers, such as Digikey, Mouser, Farnell, RS, etc.

A standard 30-pin, 0.5mm pitch, 0.3mm thick FFC, FFC connector. They are available in Top Contact and Bottom Contact, so depending how you orientate the cable on your product, will determine which one you need. Please however take care of the pinout and how it flows from the display module, through the FFC and into your product, to ensure Pin1 and Pin30 are where you expect them to be.

13. Mechanical Details

13.1. 2.4" Non-Touch, Resistive Touch and Capacitive Touch

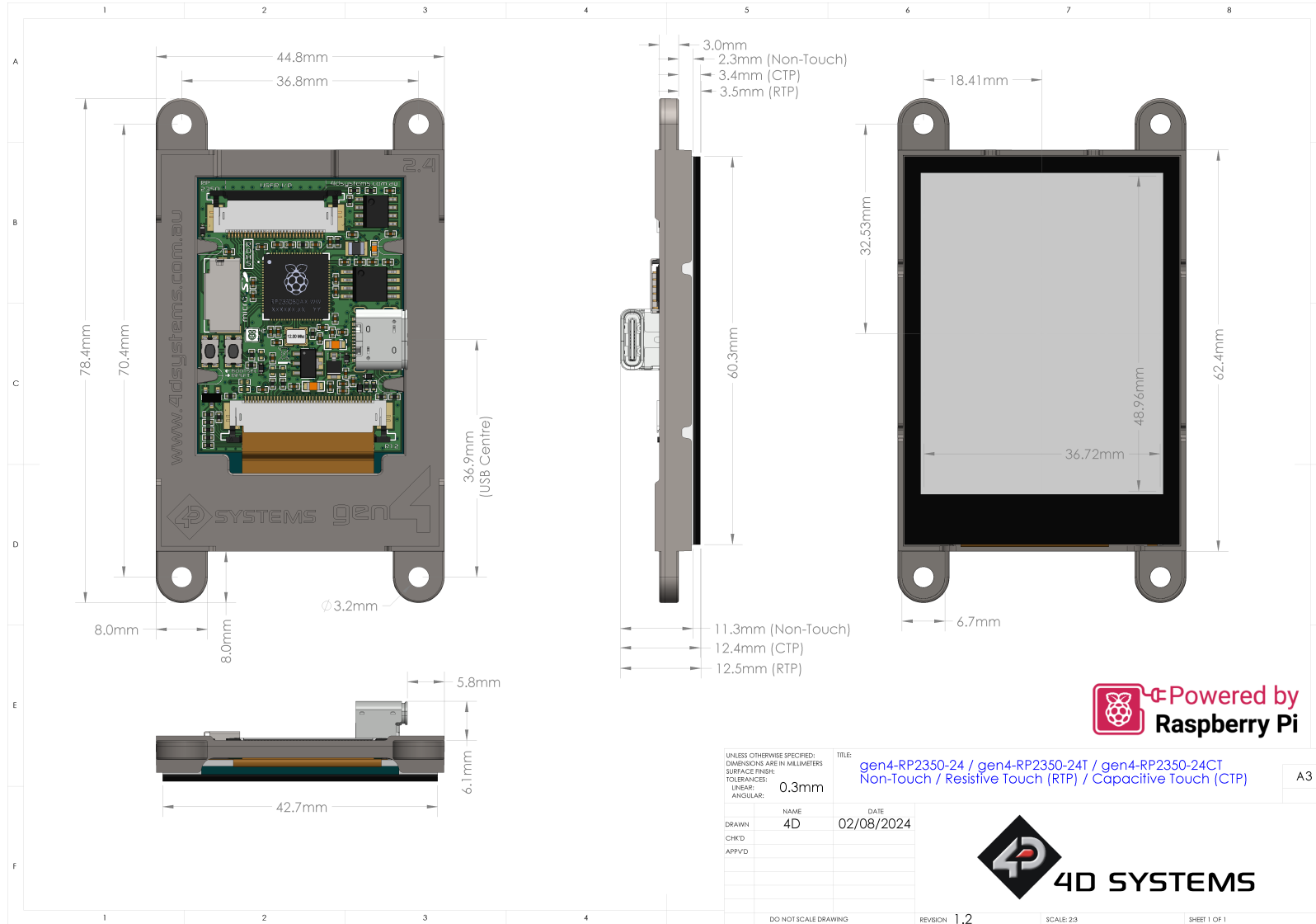

13.3. 2.8" Non-Touch, Resistive Touch and Capacitive Touch

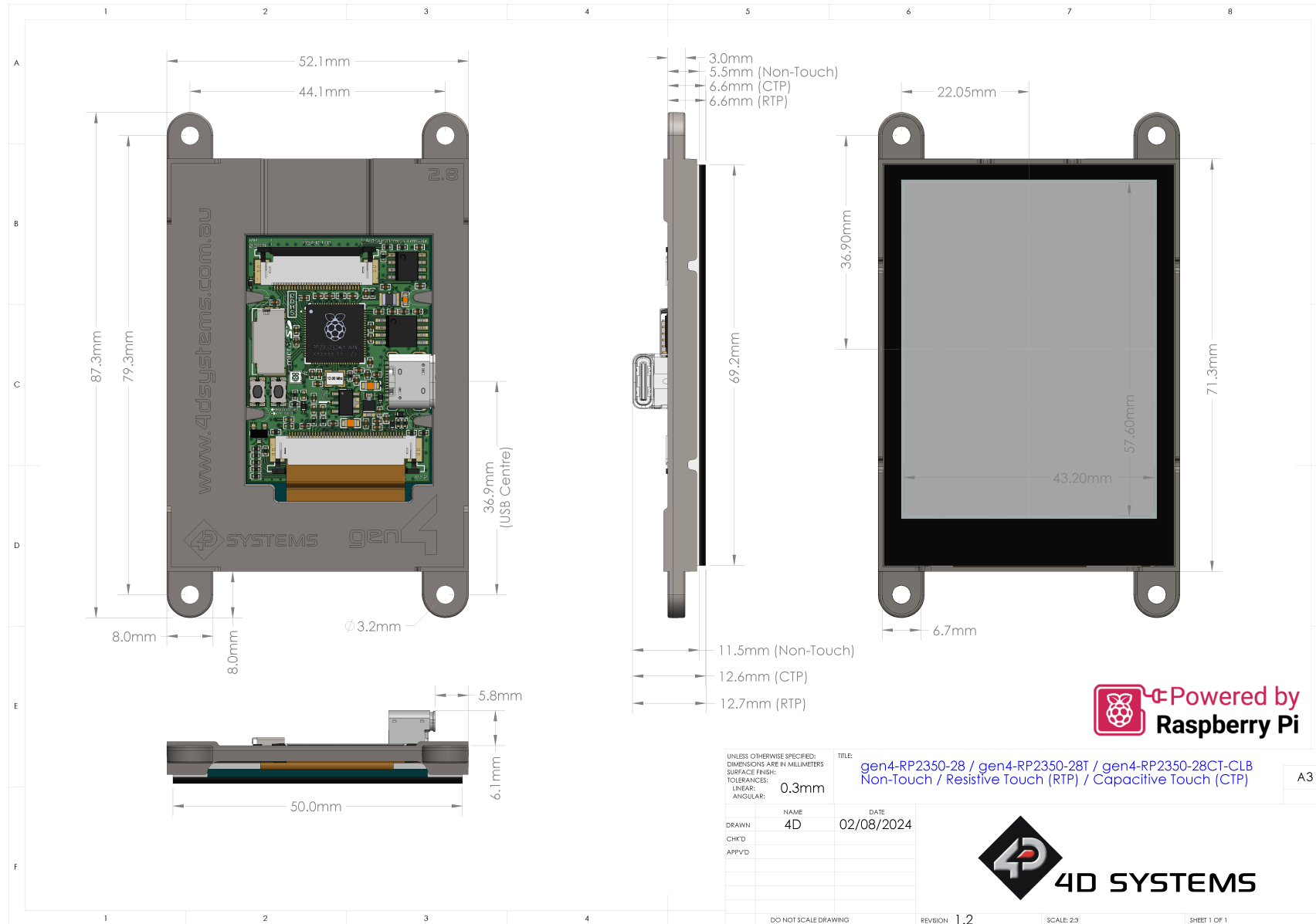

14. 2.8" Capacitive Touch with CLB

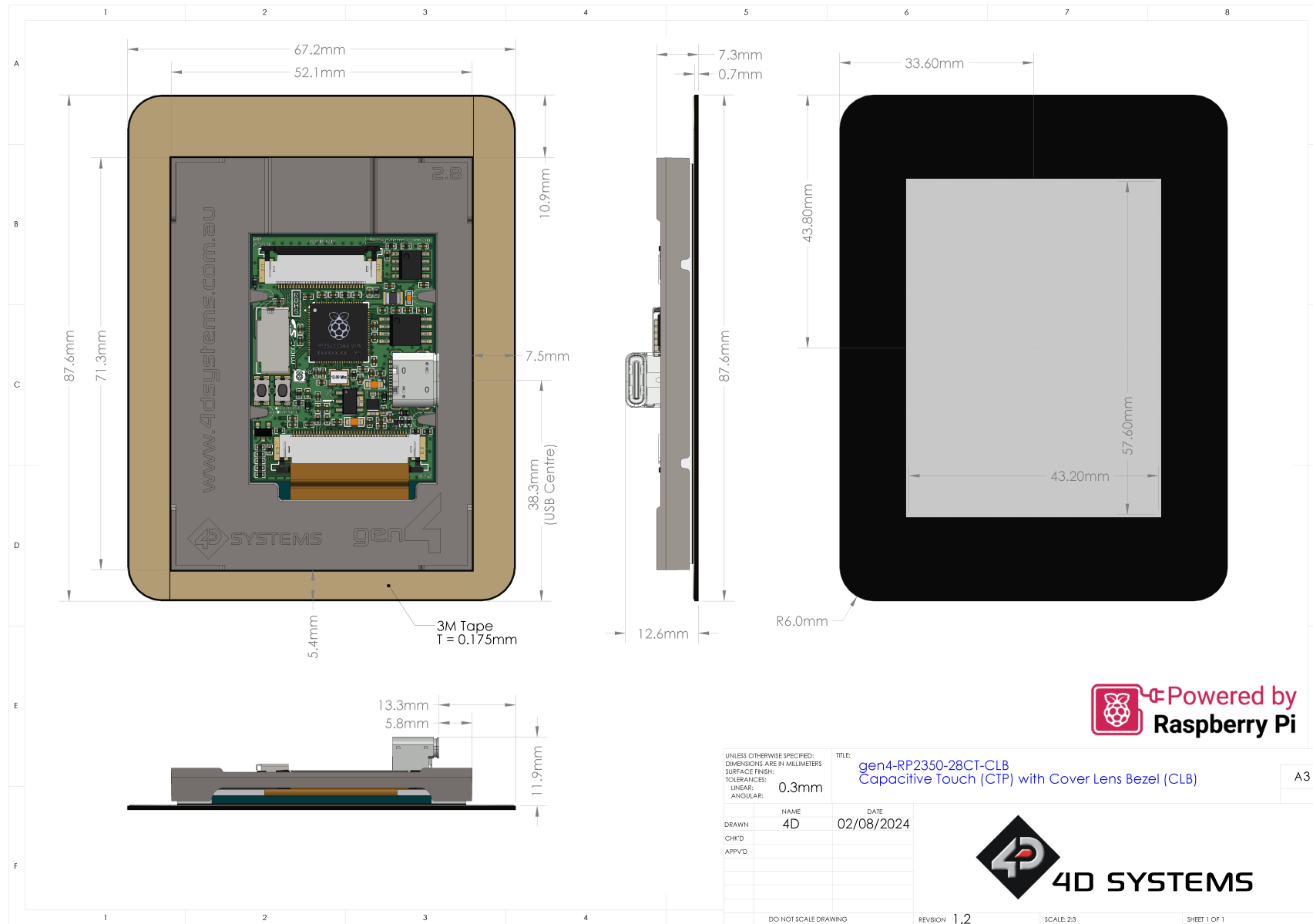

15. 3.2" Non-Touch, Resistive Touch and Capacitive Touch

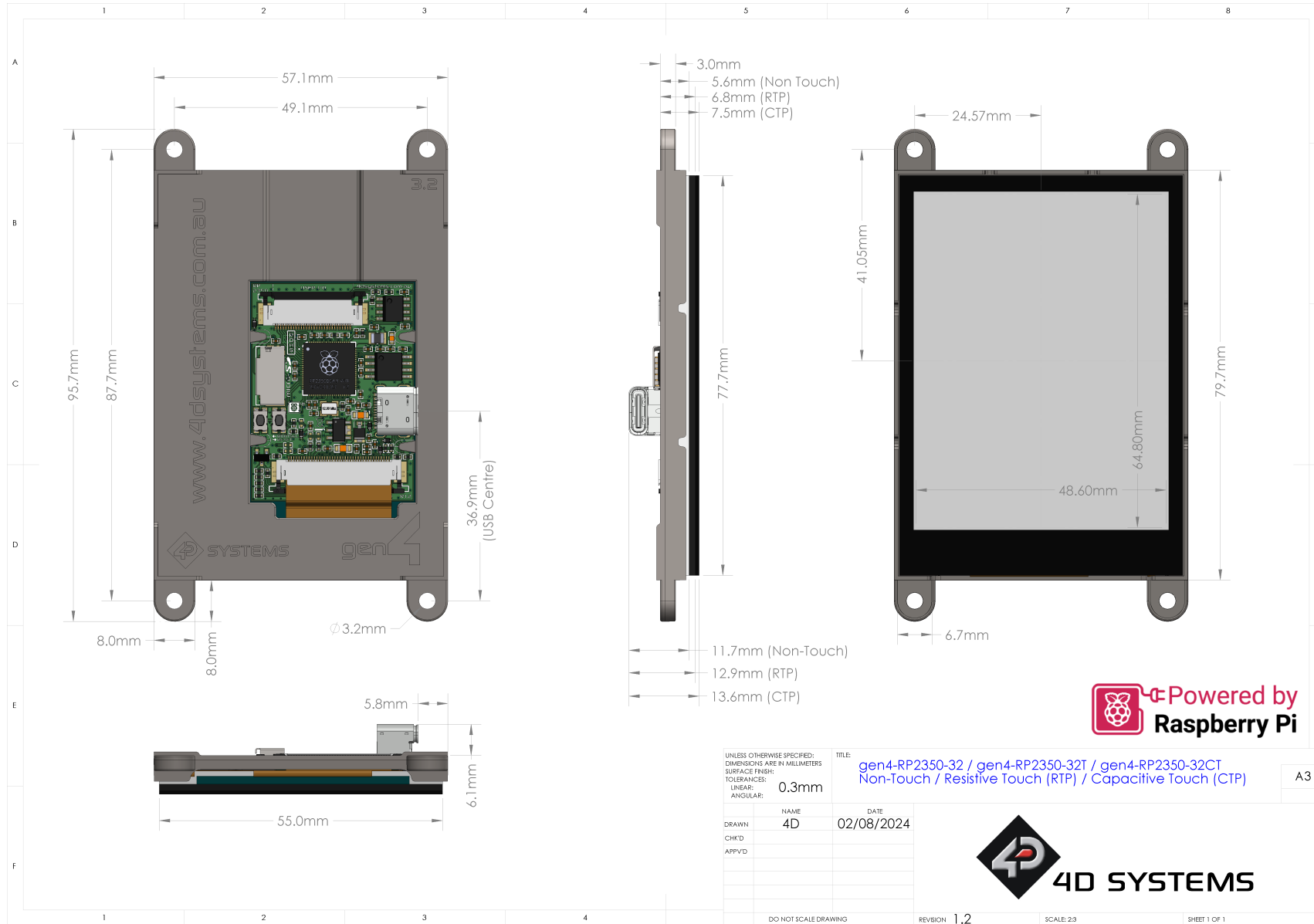

16. 3.2" Capacitive Touch with CLB

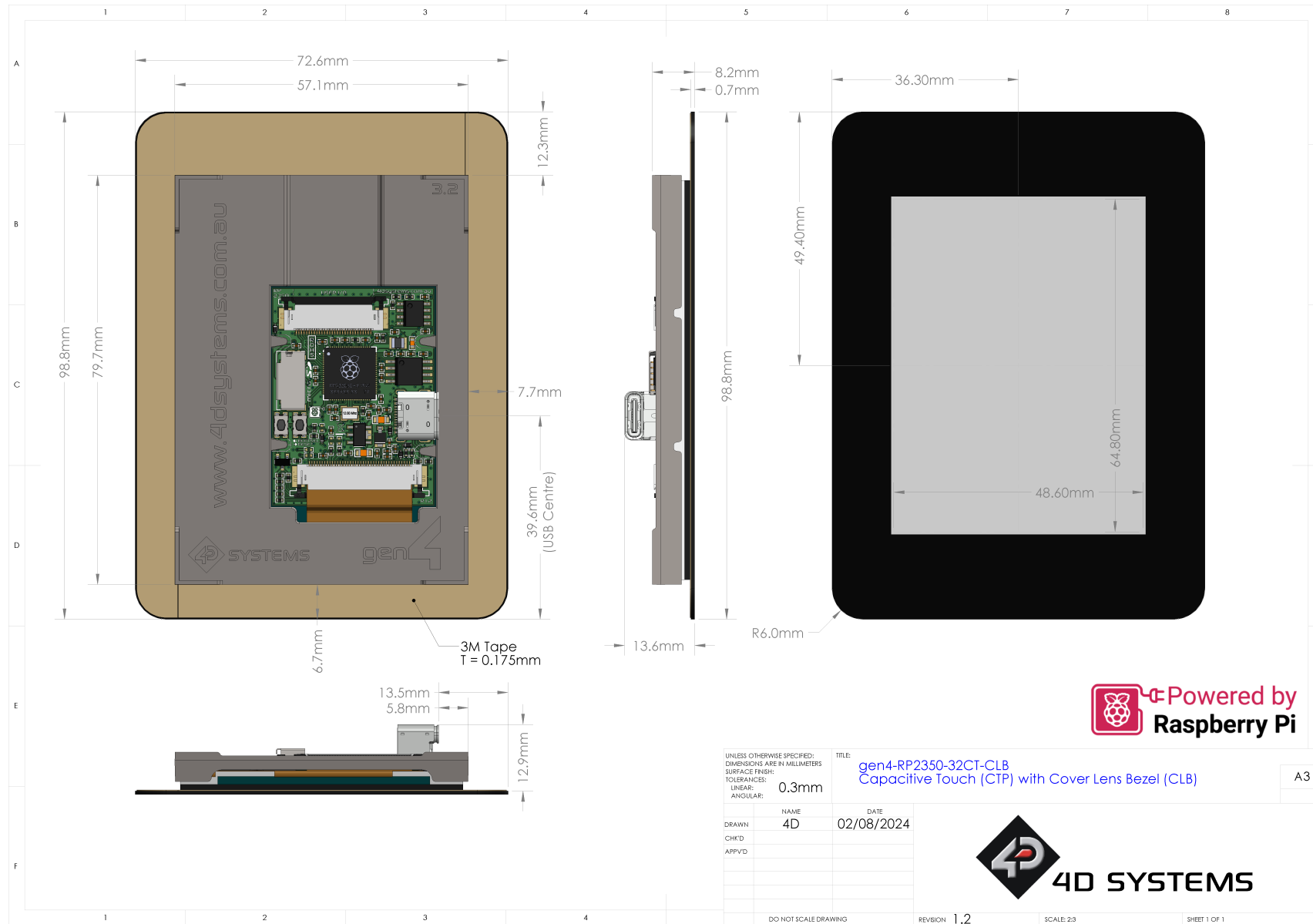

UNLESS OTHERWISE SPECIFIED:
 DIMENSIONS ARE IN MILLIMETERS
 SURFACE FINISH:
 TOLERANCES:
 LINEAR: 0.3mm
 ANGULAR:
 TITLE: gen4-RP2350-32CT-CLB
 Capacitive Touch (CTP) with Cover Lens Bezel (CLB)

A3

DRAWN	NAME	DATE
CHE'D	4D	02/08/2024
APP'VD		



DO NOT SCALE DRAWING REVISION: 1.2 SCALE: 2:3 SHEET 1 OF 1

17. 3.5" Non-Touch, Resistive Touch and Capacitive Touch

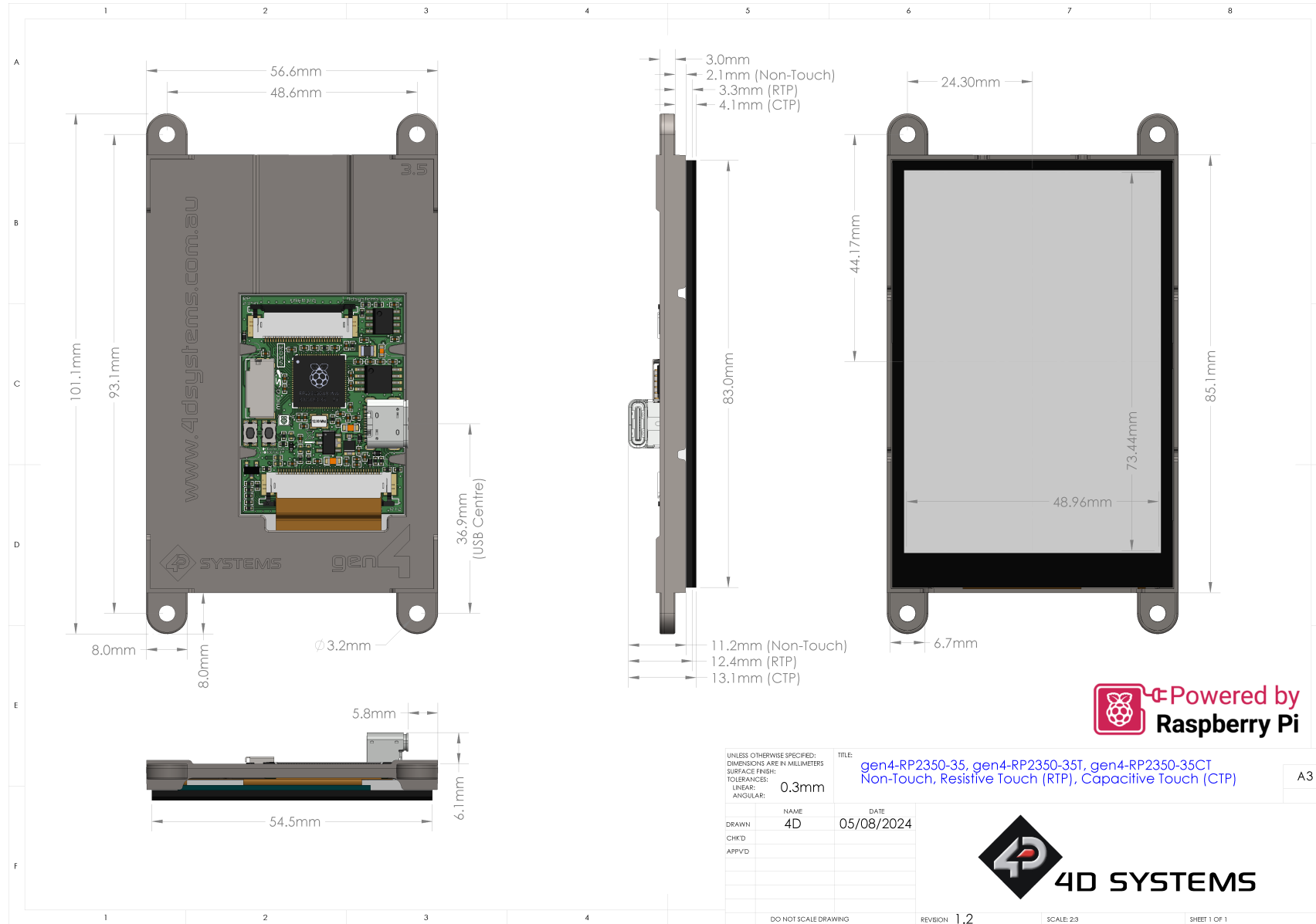

18. 3.5" Capacitive Touch with CLB

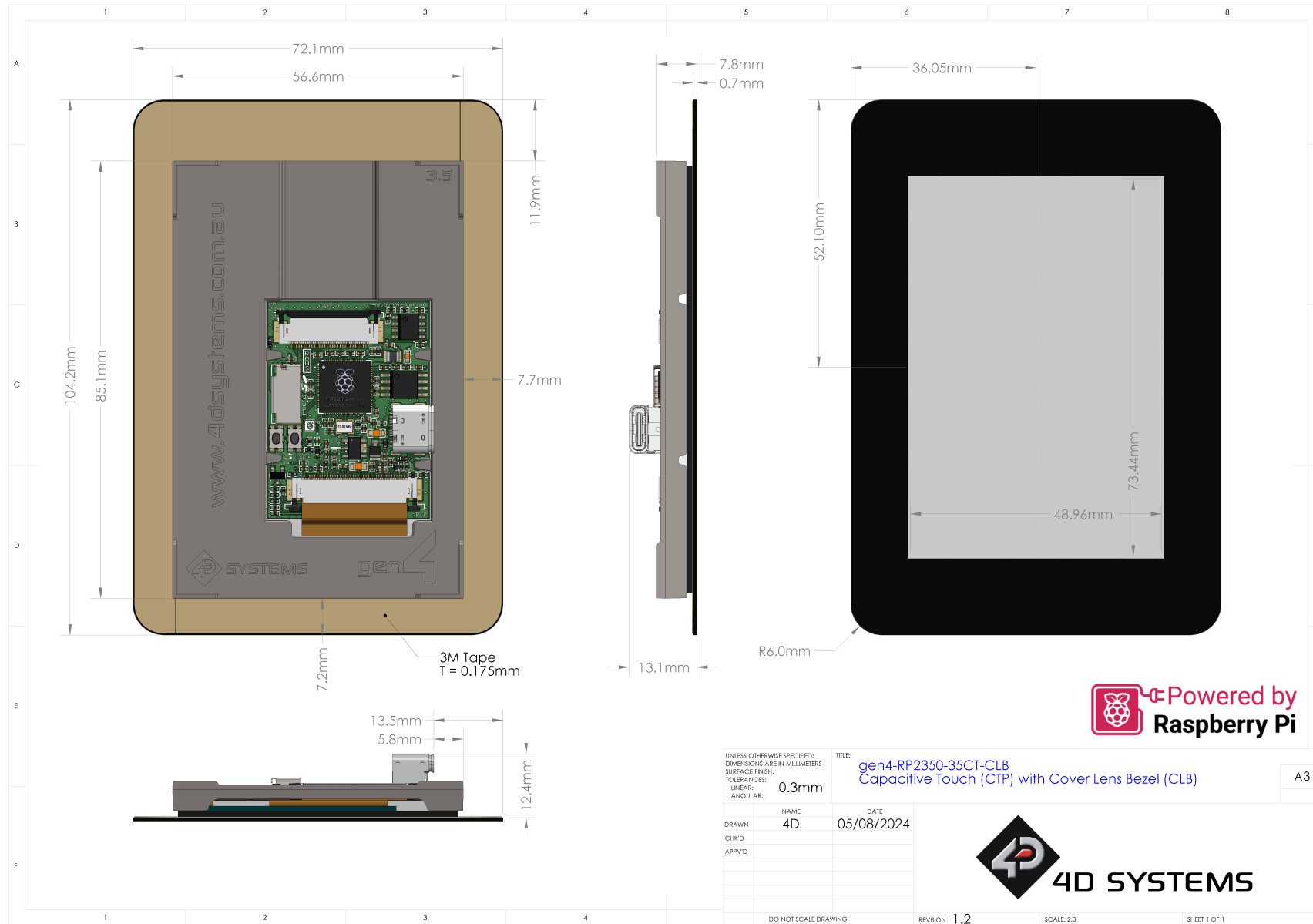

19. Schematic Circuit Details

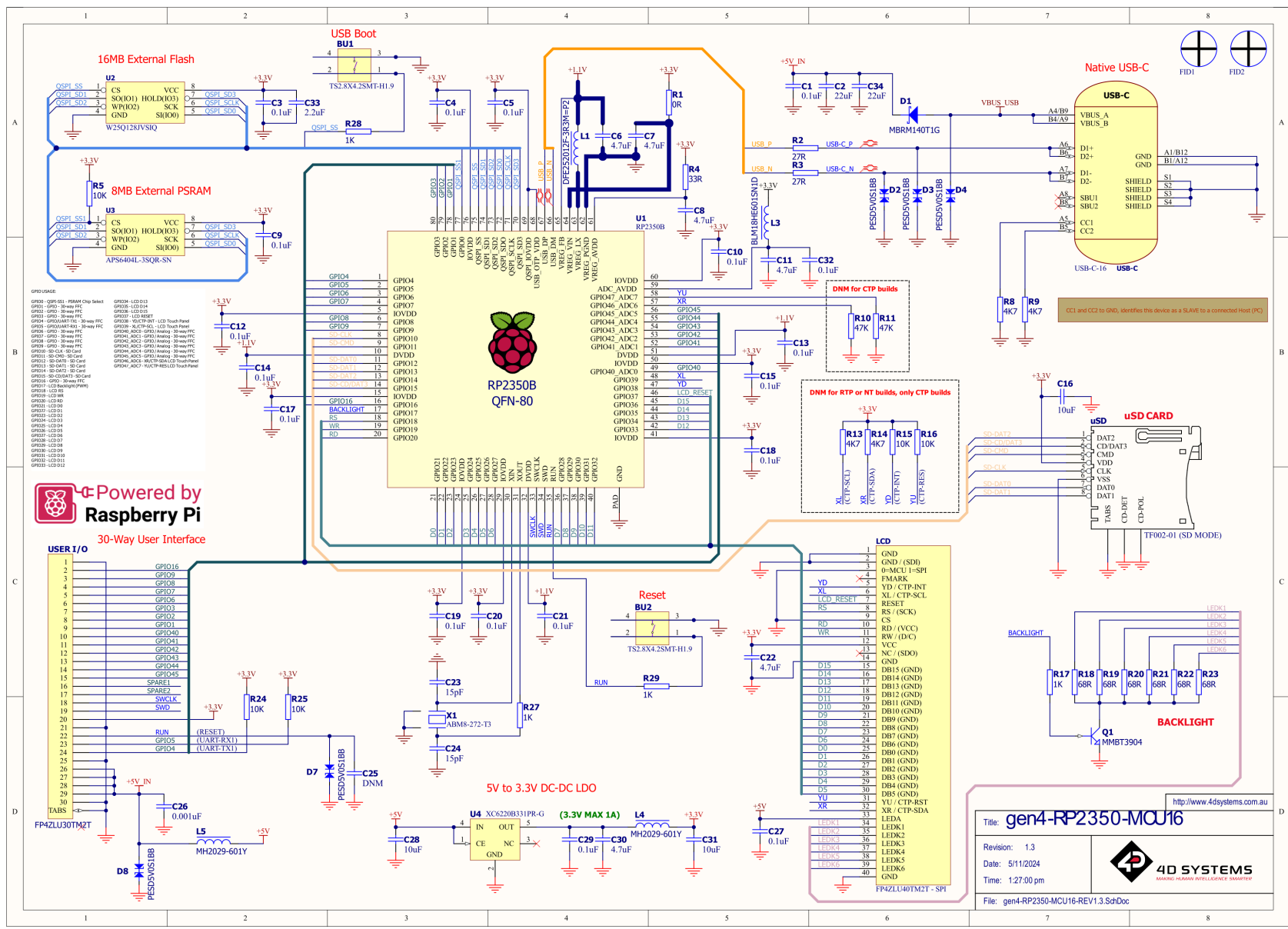

20. Specifications

Absolute Maximum Ratings

Operating ambient temperature	-20°C to +65°C (see note 1)
Storage temperature	-30°C to +80°C
Voltage on any digital input pin (RP2350) with respect to GND	-0.3V to 3.6V
Voltage on VCC with respect to GND	-0.3V to 6.5V

Note

1. Temperature range for Ambient and Storage, are determined by a combination of components used on these modules. While some components may be capable of exceeding these temperatures, some are not, so the minimums/maximums are determined by the weakest device on the modules. The 'weakest' component on the module is the TFT LCD, which is capable of -20°C to 70°C Operating Temp.
2. Stresses above those listed here may cause permanent damage to the device. This is for stress rating only and functional operation of the device at those or any other conditions above those indicated in the recommended operation listings of this specification is not implied. Exposure to maximum rating conditions for extended periods may affect device reliability.

Recommended Operating Conditions

Parameter	Conditions	Min	Typ	Max	Units
Supply Voltage (VCC)	Stable external supply required	4.0	5.0	6.0	V
Processor voltage (VP)		–	3.3	–	V
Input Low Voltage (VIL)	all pins	0	–	0.25VP	V
Input High Voltage (VIH)	all pins	0.8VP	–	5.5	V

Global Characteristics Based on Operating Conditions

Parameter	Conditions	Min	Typ	Max	Units
Supply Current (ICC) ***	gen4-RP2350-24 (Contrast = 15)	–	149	–	mA
	gen4-RP2350-24T (Contrast = 15)	–	155	–	mA
	gen4-RP2350-24CT[-CLB](Contrast = 15)	–	150	–	mA
	gen4-RP2350-28 (Contrast = 15)	–	149	–	mA
	gen4-RP2350-28T (Contrast = 15)	–	155	–	mA
	gen4-RP2350-28CT[-CLB](Contrast = 15)	–	150	–	mA
	gen4-RP2350-32 (Contrast = 15)	–	188	–	mA
	gen4-RP2350-32T (Contrast = 15)	–	195	–	mA
	gen4-RP2350-32CT[-CLB](Contrast = 15)	–	190	–	mA
	gen4-RP2350-35 (Contrast = 15)	–	183	–	mA
	gen4-RP2350-35T (Contrast = 15)	–	189	–	mA
	gen4-RP2350-35CT[-CLB](Contrast = 15)	–	184	–	mA
	Display Endurance	Hours of operation, measured to when display is 50% original brightness	30000	–	–
Touch Screen Transparency	Capacitive Touch	90	–	–	%
CLB Hardness	Cover Lens Bezel Glass Hardness	–	6	–	H

Note

Typical Supply Current (ICC) figures are without microSD card inserted, and using simple display operations only. Any additional load such as GPIO sourcing etc, will increase this figure. This is a Typical figure only, not a Maximum.

LCD Display Information

Parameter	Conditions	Specification
Display Type	2.4", 2.8" and 3.5" Models	IPS - TFT Transmissive LCD
	3.2" Models	TN - TFT Transmissive LCD
Display Size	2.4" Models	2.4" Diagonal
	2.8" Models	2.8" Diagonal
	3.2" Models	3.2" Diagonal
	3.5" Models	3.5" Diagonal
Display Resolution	2.4", 2.8" and 3.2" Models	240 x 320 (Portrait Viewing)
	3.5" Models	320 x 480 (Portrait Viewing)
Display Brightness	gen4-RP2350-24 (Contrast = 15)	320 cd/m ²
	gen4-RP2350-24T (Contrast = 15)	270 cd/m ²
	gen4-RP2350-24C[T-CLB](Contrast = 15)	300 cd/m ²
	gen4-RP2350-28 (Contrast = 15)	300 cd/m ²
	gen4-RP2350-28T (Contrast = 15)	250 cd/m ²
	gen4-RP2350-28CT[-CLB](Contrast = 15)	280 cd/m ²
	gen4-RP2350-32 (Contrast = 15)	200 cd/m ²
	gen4-RP2350-32T (Contrast = 15)	160 cd/m ²
	gen4-RP2350-32T[-CLB](Contrast = 15)	190 cd/m ²
	gen4-RP2350-35 (Contrast = 15)	320 cd/m ²
	gen4-RP2350-35T (Contrast = 15)	270 cd/m ²
	gen4-RP2350-35CT[-CLB](Contrast = 15)	295 cd/m ²
Display Contrast Ratio	Typical (2.4", 2.8")	800:1
	Typical (3.2")	250:1
	Typical (3.5")	1000:1
Display Viewing Angles	2.4", 2.8" and 3.5" Models	80 Degrees all directions
	3.2" Models	35 Degrees Above Centre, 55 Degrees other directions
Display Viewing Direction	2.4", 2.8" and 3.5" Models	ALL (wide viewing IPS Display)
	3.2" Models	6 O'clock Display (Optimal viewing is from below when in Portrait mode)
Display Backlighting	2.4" and 2.8" Models	1x4 Parallel LED's
	3.2" and 3.5" Models	1x6 Parallel LED's
Pixel Pitch	2.4" Models	0.153 x 0.153mm
	2.8" Models	0.180 x 0.180mm
	3.2" Models	0.2025 x 0.2025mm
	3.5" Models	0.153 x 0.153mm
Pixel Density	Number of pixels in 1 row in 25.4mm, 2.4"	166 DPI/PPI
	Number of pixels in 1 row in 25.4mm, 2.8"	141 DPI/PPI
	Number of pixels in 1 row in 25.4mm, 3.2"	127 DPI/PPI

Parameter	Conditions	Specification
	Number of pixels in 1 row in 25.4mm, 3.5"	166 DPI/PPI

Note

Relevant for all TN and IPS displays, the Displays used are of the highest rated 'Grade A', which allows for 0-4 defective pixels.

A defective pixel could be solid Black (Dead), White, Red, Green or Blue.

21. Revision History

Datasheet Revision

Revision Number	Date	Description
1.0	04/11/2024	Initial Public Release Version
1.1	16/12/2024	Fixed hardware revision history

Hardware Revision

Revision Number	Date	Description
1.2	08/08/2024	Initial Public Release Version
1.3	16/12/2024	Minor layout changes as per Raspberry Pi recommendations

22. Legal Notice

22.1. Proprietary Information

The information contained in this document is the property of 4D Systems Pty. Ltd. and may be the subject of patents pending or granted, and must not be copied or disclosed without prior written permission. 4D Systems endeavours to ensure that the information in this document is correct and fairly stated but does not accept liability for any error or omission. The development of 4D Systems products and services is continuous and published information may not be up to date. It is important to check the current position with 4D Systems. 4D Systems reserves the right to modify, update or makes changes to Specifications or written material without prior notice at any time.

All trademarks belong to their respective owners and are recognised and acknowledged.

22.2. Disclaimer of Warranties & Limitations of Liabilities

4D Systems makes no warranty, either expressed or implied with respect to any product, and specifically disclaims all other warranties, including, without limitation, warranties for merchantability, non-infringement and fitness for any particular purpose.

Information contained in this publication regarding device applications and the like is provided only for your convenience and may be superseded by updates. It is your responsibility to ensure that your application meets with your specifications.

Images and graphics used throughout this document are for illustrative purposes only. All images and graphics used are possible to be displayed on the 4D Systems range of products, however the quality may vary.

In no event shall 4D Systems be liable to the buyer or to any third party for any indirect, incidental, special, consequential, punitive or exemplary damages (including without limitation lost profits, lost savings, or loss of business opportunity) arising out of or relating to any product or service provided or to be provided by 4D Systems, or the use or inability to use the same, even if 4D Systems has been advised of the possibility of such damages.

4D Systems products are not fault tolerant nor designed, manufactured or intended for use or resale as on line control equipment in hazardous environments requiring fail - safe performance, such as in the operation of nuclear facilities, aircraft navigation or communication systems, air traffic control, direct life support machines or weapons systems in which the failure of the product could lead directly to death, personal injury or severe physical or environmental damage ('High Risk Activities'). 4D Systems and its suppliers specifically disclaim any expressed or implied warranty of fitness for High Risk Activities.

Use of 4D Systems' products and devices in 'High Risk Activities' and in any other application is entirely at the buyer's risk, and the buyer agrees to defend, indemnify and hold harmless 4D Systems from any and all damages, claims, suits, or expenses resulting from such use. No licenses are conveyed, implicitly or otherwise, under any 4D Systems intellectual property rights.