



3000W Power Supply with Single Output

CSP-3000 series



Dimension

L	W	H	
278	177.8	63.5(2U)	mm
10.9	7	2.5 (2U)	inch



Features

- AC input 180~264VAC
- Built-in active PFC function
- High efficiency up to 93%
- Forced air cooling by built-in DC fans
- Output voltage / current programmable
- Active current sharing up to 9000W(2+1)
- Built-in remote ON-OFF control / auxiliary power / power OK signal
- Protections: Short circuit / Overload / Over voltage / Over temperature / Fan failure
- Conformal coating
- Programmable output voltage & constant current function
- 5 years warranty

Description

CSP-3000 is a 3KW single output enclosed type AC/DC power supply. This series operates for 180~264VAC input voltage and offers the models with the DC output mostly demanded from the industry. Each model is cooled by the built-in fan with fan speed control, working for the temperature up to 65°C. Moreover, CSP-3000 provides vast design flexibility by equipping various built-in functions such as the output programming, active current sharing, remote ON-OFF control, auxiliary power, etc.

Model Encoding / Order Information

CSP - 3000 - 250

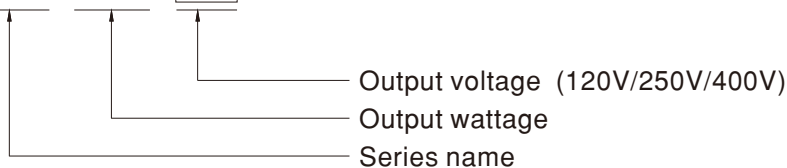

Applications

- Factory control or automation apparatus
- Test and measurement instrument
- Laser related machine
- UV curing equipment
- Fish lamp
- Burn-in facility

GTIN CODE

MW Search: <https://www.meanwell.com/serviceGTIN.aspx>

SPECIFICATION

MODEL		CSP-3000-120	CSP-3000-250	CSP-3000-400	
OUTPUT	DC VOLTAGE	120V	250V	400V	
	RATED CURRENT	25A	12A	7.5A	
	CURRENT RANGE	0 ~ 25A	0 ~ 12A	0 ~ 7.5A	
	RATED POWER	3000W	3000W	3000W	
	RIPPLE & NOISE (max.) Note.2	800mVp-p	1000mVp-p	1200mVp-p	
	CONSTANT CURRENT REGION	90 ~ 120V	125 ~ 250V	200 ~ 400V	
	VOLTAGE TOLERANCE Note.3	±1.0%	±1.0%	±1.0%	
	LINE REGULATION	±0.5%	±0.5%	±0.5%	
	LOAD REGULATION	±0.5%	±0.5%	±0.5%	
	SETUP, RISE TIME	1000ms, 80ms / 230VAC at full load			
HOLD UP TIME (Typ.)	10ms at full load				
INPUT	VOLTAGE RANGE Note.4	180 ~ 264VAC 254 ~ 370VDC			
	FREQUENCY RANGE	47~63Hz			
	POWER FACTOR (Typ.)	PF ≥ 0.95 / 230VAC at full load			
	EFFICIENCY (Typ.)	92%	92.5%	93%	
	AC CURRENT (Typ.)	20A/180VAC 16A/230VAC			
	INRUSH CURRENT (Typ.)	Cold start 60A/230VAC			
LEAKAGE CURRENT	<0.3mA / 240VAC				
PROTECTION	SHORT CIRCUIT	Shut down and latch off o/p voltage, re-power on to recover			
	OVER CURRENT	105 ~ 120% rated output power User adjustable continuous constant current limiting or constant current limiting with delay shutdown after 3 seconds, re-power on to recover (Please refer to the Function Manual)			
	OVER VOLTAGE	127 ~ 150V	265 ~ 315V	420 ~ 500V	
		Protection type : Shut down o/p voltage, re-power on to recover			
OVER TEMPERATURE	Shut down o/p voltage, recovers automatically after temperature goes down or re-power on to recover				
FUNCTION	OUTPUT VOLTAGE PROGRAMMABLE(PV)	Please refer to the Function Manual.			
	OUTPUT CONSTANT CURRENT PROGRAMMABLE(PC)	Please refer to the Function Manual.			
	CURRENT SHARING	Please refer to the Function Manual.			
	AUXILIARY POWER(AUX)	12V@0.4A			
	REMOTE ON-OFF CONTROL	Please refer to the Function Manual			
	ALARM SIGNAL OUTPUT	Power OK signal. Please refer to the Function Manual			
ENVIRONMENT	WORKING TEMP.	-20 ~ +65°C (Refer to "Derating Curve")			
	WORKING HUMIDITY	20 ~ 90% RH non-condensing			
	STORAGE TEMP., HUMIDITY	-40 ~ +85°C, 10 ~ 95% RH non-condensing			
	TEMP. COEFFICIENT	±0.05%/°C (0 ~ 50°C)			
	VIBRATION	10 ~ 500Hz, 2G 10min./1cycle, 60min. each along X, Y, Z axes			
SAFETY & EMC (Note 5)	SAFETY STANDARDS	UL62368-1, BS EN/EN62368-1, EAC TP TC004, GB4943.1			
	WITHSTAND VOLTAGE	I/P-O/P:3KVAC I/P-FG:2KVAC O/P-FG:0.5KVAC			
	ISOLATION RESISTANCE	I/P-O/P, I/P-FG, O/P-FG:100M Ohms / 500VDC / 25°C / 70% RH			
	EMC EMISSION	Parameter	Standard	Test Level / Note	
		Conducted	BS EN/EN55032(CISPR32)	Class A	
		Radiated	BS EN/EN55032(CISPR32)	Class A	
		Harmonic Current	BS EN/EN61000-3-2	-----	
		Voltage Flicker	BS EN/EN61000-3-3	-----	
	EMC IMMUNITY	BS EN/EN55035 ,BS EN/EN61000-6-2			
		Parameter	Standard	Test Level / Note	
		ESD	BS EN/EN61000-4-2	Level 3, 8KV air ; Level 2, 4KV contact	
		Radiated	BS EN/EN61000-4-3	Level 3	
		EFT / Burst	BS EN/EN61000-4-4	Level 3	
		Surge	BS EN/EN61000-4-5	Level 3, 2KV/Line-Earth ; Level 2, 1KV/Line-Line	
Conducted		BS EN/EN61000-4-6	Level 3		
Magnetic Field		BS EN/EN61000-4-8	Level 4		
Voltage Dips and Interruptions	BS EN/EN61000-4-11	>95% dip 0.5 periods, 30% dip 25 periods, >95% interruptions 250 periods			
OTHERS	MTBF	721.1K hrs min. Telcordia SR-332 (Bellcore) ; 80.5K hrs min. MIL-HDBK-217F (25°C)			
	DIMENSION	278*177.8*63.5mm (L*W*H)			
	PACKING	3.5Kg; 4pcs/14.4Kg/1.39CUFT			
NOTE	<p>1. All parameters NOT specially mentioned are measured at 230VAC input, rated load and 25°C of ambient temperature.</p> <p>2. In the PV Mode: Ripple & noise are measured at 20MHz of bandwidth by using a 12" twisted pair-wire terminated with a 0.1uf & 47uf parallel capacitor.</p> <p>3. Tolerance : includes set up tolerance, line regulation and load regulation.</p> <p>4. Turn off the output when input voltage is less than 160VAC.</p> <p>5. The power supply is considered a component which will be installed into a final equipment. All the EMC tests are been executed by mounting the unit on a 720mm*360mm metal plate with 1mm of thickness. The final equipment must be re-confirmed that it still meets EMC directives. For guidance on how to perform these EMC tests, please refer to "EMI testing of component power supplies." (as available on https://www.meanwell.com/Upload/PDF/EMI_statement_en.pdf)</p> <p>6. The ambient temperature derating of 3.5°C/1000m with fanless models and of 5°C/1000m with fan models for operating altitude higher than 2000m(6500ft).</p>				

Block Diagram

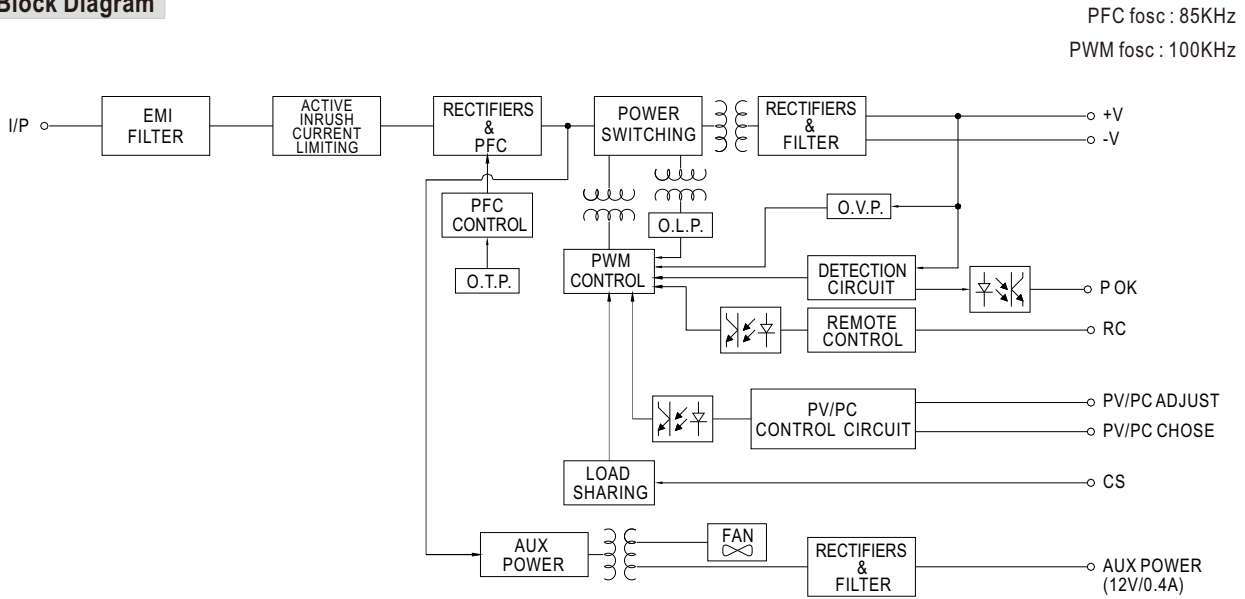

Static Characteristics

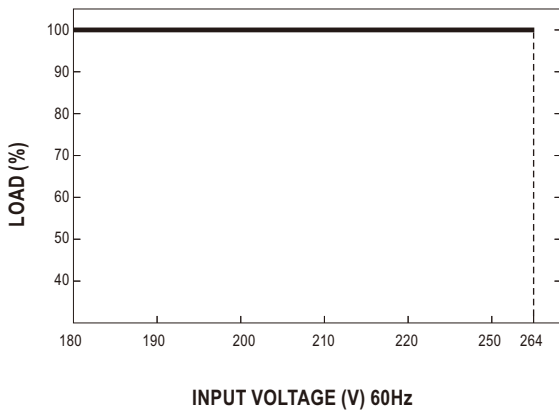

Derating Curve

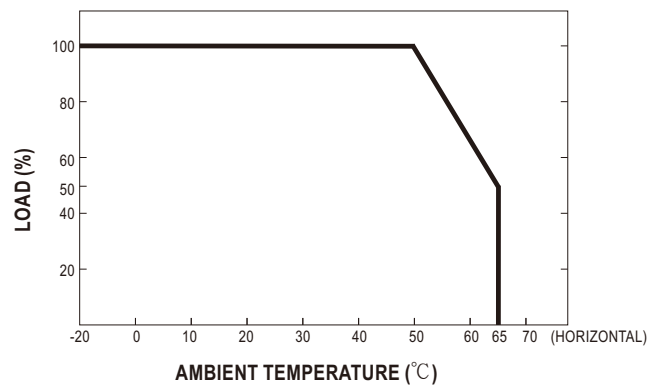

Efficiency vs Load (400V Model)

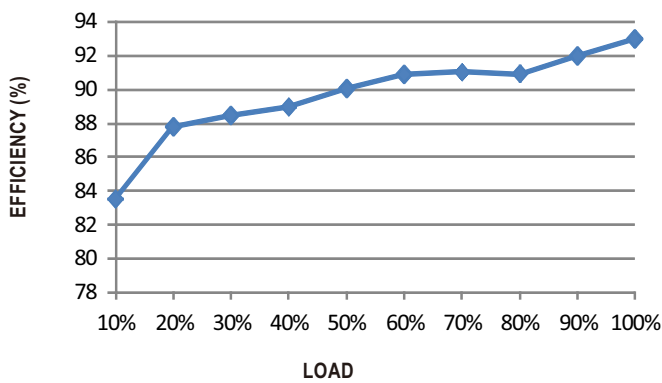

※ The curve above is measured at 230VAC.

DRIVING METHODS OF LED MODULE

※ I-V Operating Area(for PC mode only)

◎ CSP-3000-120

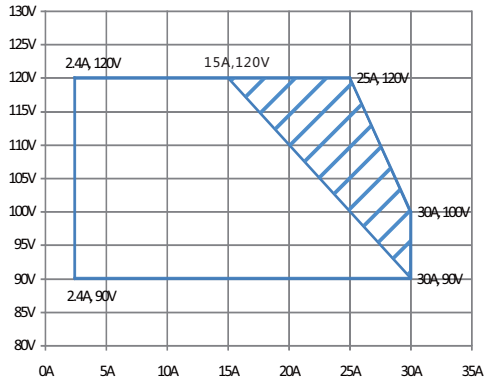

Recommended High Performance Region Allowed Operational Region

◎ CSP-3000-250

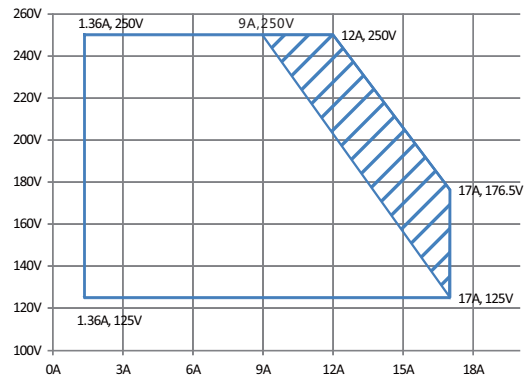

Recommended High Performance Region Allowed Operational Region

◎ CSP-3000-400

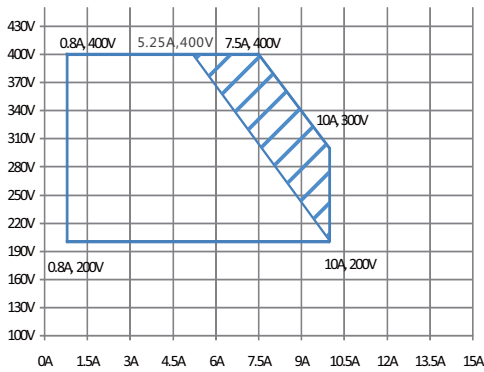

Recommended High Performance Region Allowed Operational Region

■ Function Manual

1. Output Voltage/Current Programming

※ Mode Setting

CN1:

	CONDITION	MODE	FUNCTION
PIN5/PIN6	SHORT	PV MODE	Output Voltage Programming
	OPEN	PC MODE	Output Current Programming

※ The factory default settings: PV mode output max voltage pin5/pin6 short by jumper cap.
When pull out the jumper cap, the default settings: PC mode output max constant current.

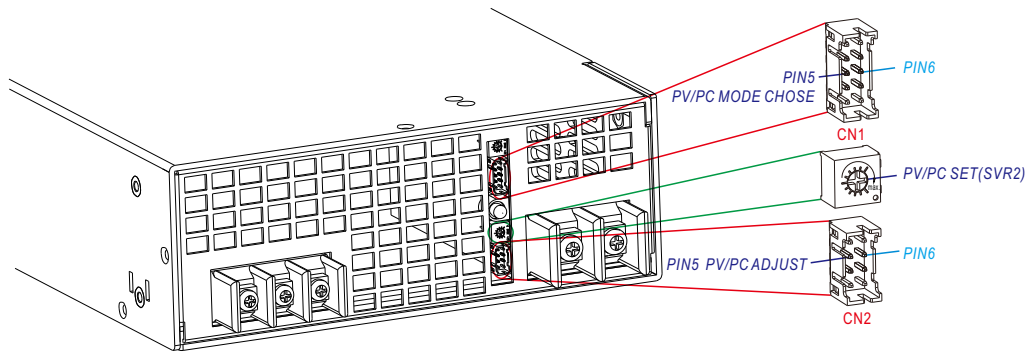

※ PV/PC Set adjustment

- ⊙ Adjust the resistance(SVR2) can set output voltage or constant current point, the adjusting range is 20%-100% of max voltage or max constant current point.
- ⊙ In the CN2, PIN5/PIN6 access external 10V voltage signal or 500-1KHz 10V PWM signal can adjust the output voltage or constant current point. (CN2:PIN5/PIN6 typical vaules of port current :100μA)

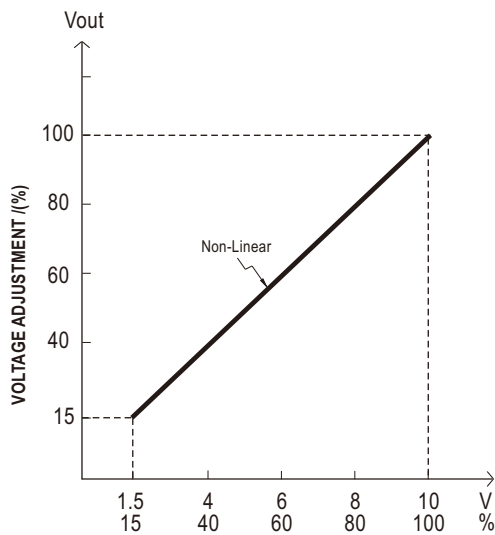

PIN5/PIN6 ACCESS TO EXTERNAL VOLTAGE SIGNALS(DC/PWM)

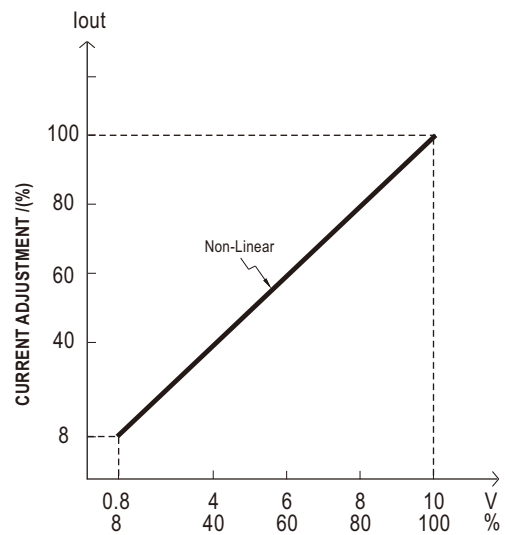

PIN5/PIN6 ACCESS TO EXTERNAL VOLTAGE SIGNALS(DC/PWM)

MODEL	120V	250V	400V
PV range	18 ~ 120V(max.)	37.5 ~ 250V(max.)	60 ~ 400V(max.)
PC range	2.4 ~ 30A(max.)	1.4~ 17A(max.)	0.8 ~ 10A(max.)

2. Remote ON-OFF

※ Remote ON-OFF is activated by the configuration with respect to CN1 as shown in the following diagram.

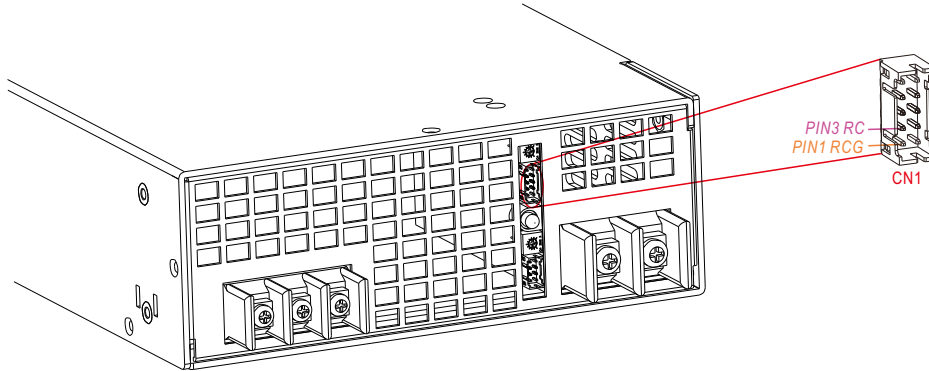

Example 2.2(A): Using external voltage source

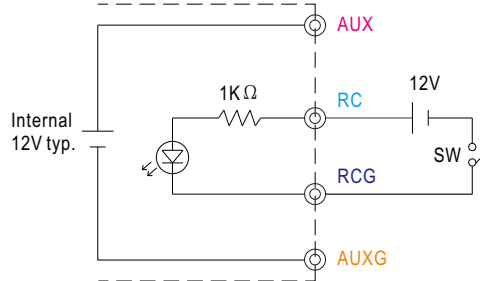

Example 2.2(B): Using internal 12V auxiliary output

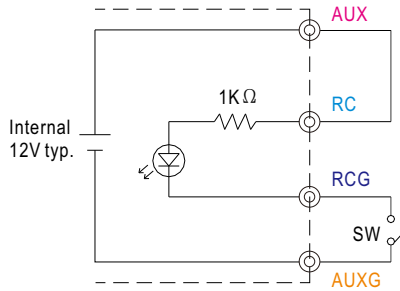

Example 2.2(C): Using internal 12V auxiliary output

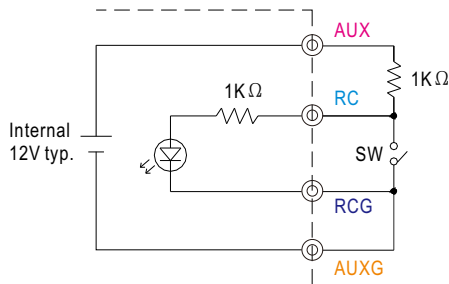

◎ Connection Method

		Example 2.2(A)	Example 2.2(B)	Example 2.2(C)
SW Logic	Power supply output ON	SW Open(open)	SW Open(open)	SW Close(short)
	Power supply output OFF	SW Close(short)	SW Close(short)	SW Open(open)

3. Alarm Signal Output

※ Alarm signal is sent out through "P OK" & "P OK GND" and P OK2 & P OK GND2 pins on CN1. Please acknowledge an external voltage source is required for this function.

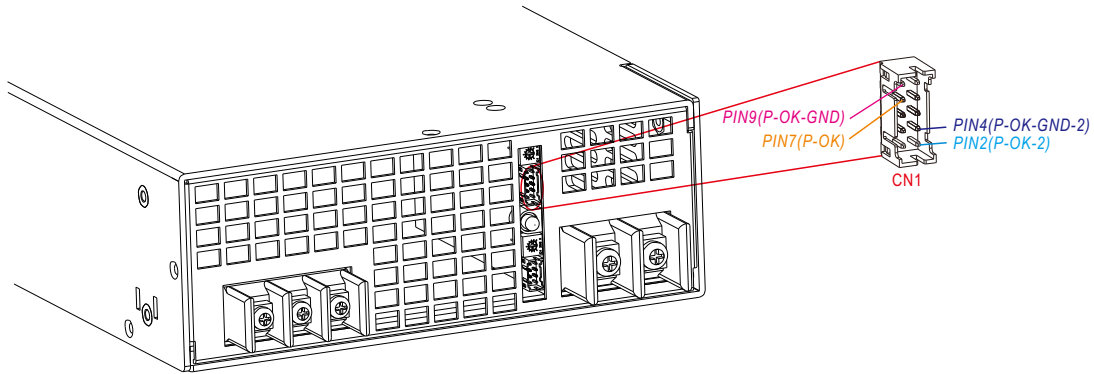

Table 3.1 Explanation of alarm

Function	Description	Output of alarm(P OK, Relay Contact)	Output of alarm(P OK2, TTL Signal)
P OK	The signal is "Low", or, say, Power OK	Low (0.5V max at 500mA)	Low (0.5V max at 10mA)
	The signal turns to be "High", or, say, Power Fail	High or open (External applied voltage, 500mA max.)	High or open (External applied voltage, 10mA max.)

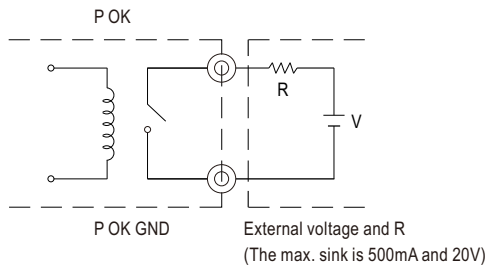

Fig. 3.2 Internal circuit of P OK (Relay, total is 10W)

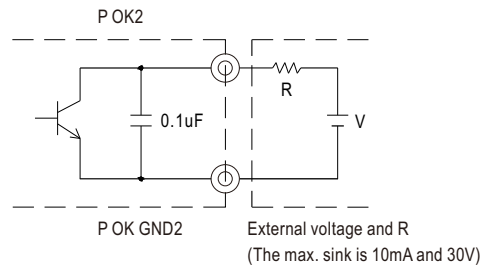

Fig. 3.3 Internal circuit of P OK2 (Open collector method)

4. Select Overload Protection Type

- (1) Insert the shorting connector on CN1 that is shown in Fig 4.1, the Overload Protection Type will be "constant current limiting with delay shutdown after 3 seconds, re-power on to recover". This is the factory default.
- (2) Remove the shorting connector on CN1 that is shown in Fig 4.2, the Overload Protection Type will be "continuous constant current limiting".

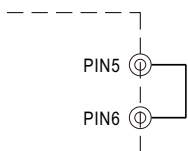

Fig. 4.1 Insert the CN1
Overload Protection Type : constant current limiting with delay shutdown after 3 seconds

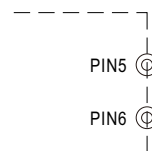

Fig. 4.2 Remove the CN1
Overload Protection Type : constant current limiting

5.Parallel

CSP-3000 can be connected in parallel, up to 3units, to provide higher output power.

When working in constant voltage parallel mode:

- ※ Built-in active current sharing function
- ※ Difference of output voltages among parallel units should be less than 0.2V(Can fine tune by SVR1)
- ※ The total output current must not exceed the value determined by the following equation:
Maximum output current at parallel operation=(Rated current per unit)×(Number of unit)×0.9
- ※ When out current<(50% rate current)×(Number of unit),
the current shared among units may not be fully balanced.
- ※ CS+/CS- on CN1 are connected mutually in parallell (Note: CS+/CS- do not reverse connection).
- ※ The "PV/PC" function is not available.

When working in constant current parallel mode:

- ※ The load carried by each power supply cannot exceed 90% of the rated power
- ※ The "PC" function can be used ,but the "PV" function is not available.

©The power supplies should be paralleled using short and large diameter wiring and then connected to the load.

No.1(Master)

No.2(Slave)

No.3(Slave)

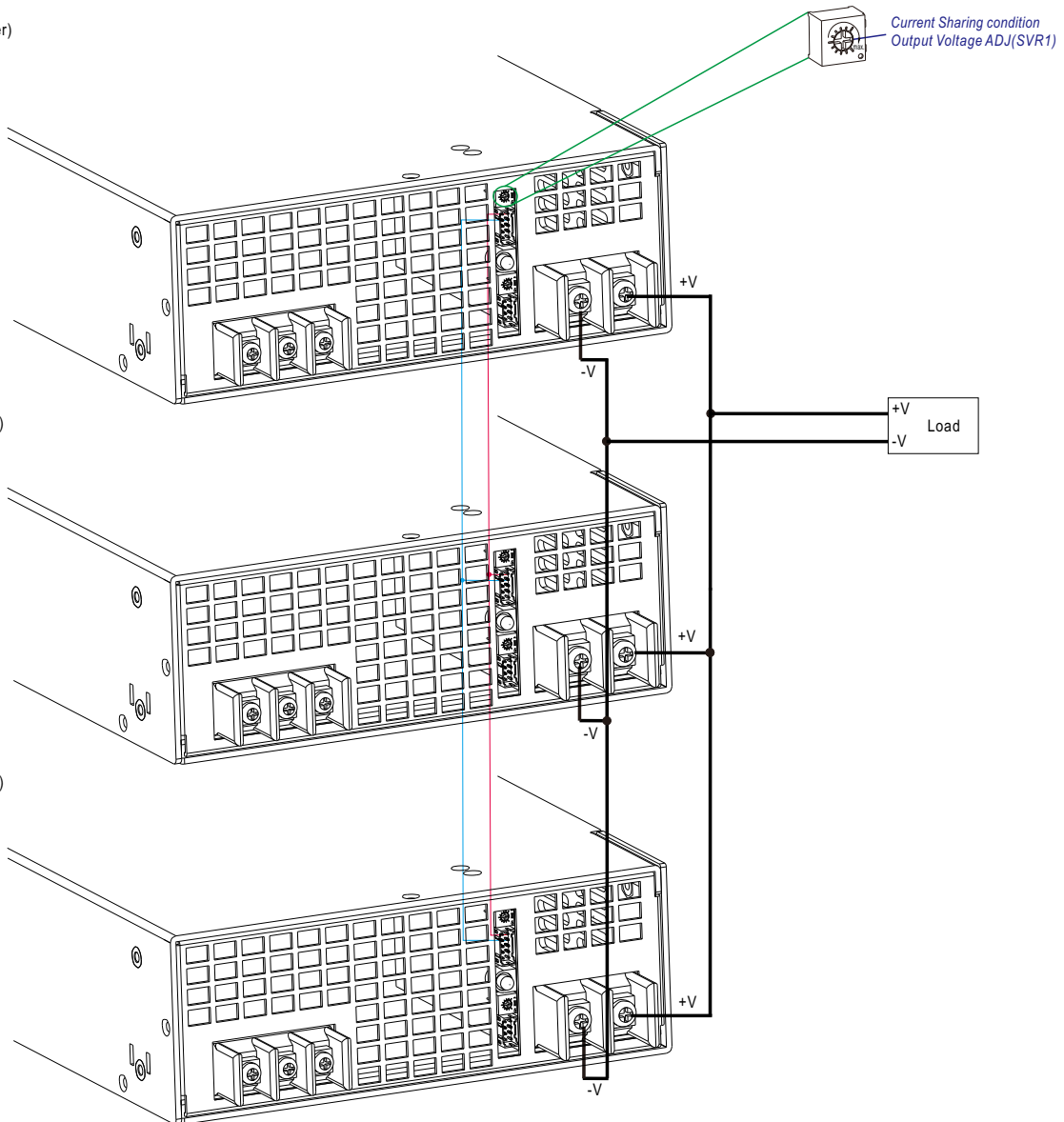

Mechanical Specification

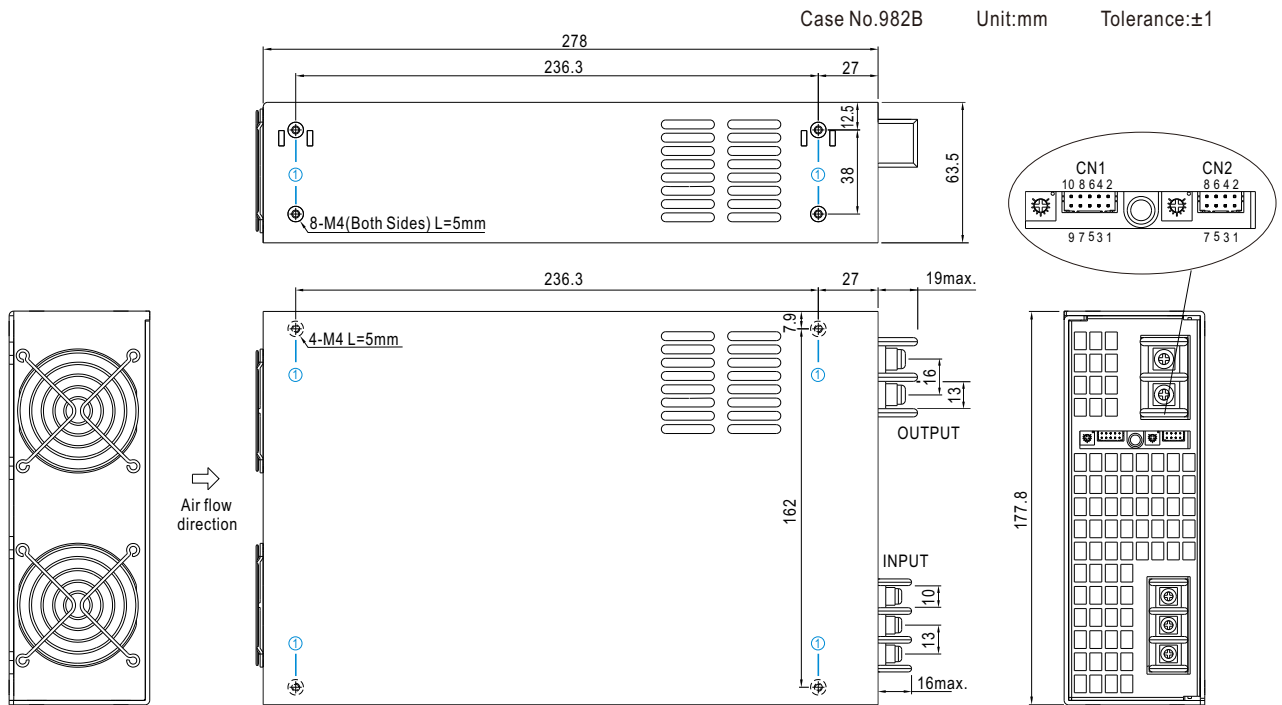

Mounting Instruction

Hole No.	Recommended Screw Size	MAX. Penetration Depth L	Recommended mounting torque
①	M4	5mm	7~10Kgf-cm

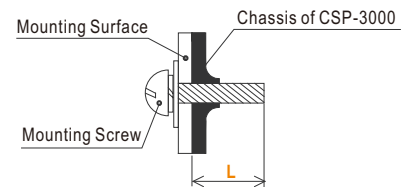

Control Pin No. Assignment (CN1) : HRS DF11-10DP-2DS or equivalent

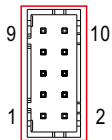

Mating Housing	HRS DF11-10DS or equivalent
Terminal	HRS DF11-**SC or equivalent

Pin No.	Function	Description
1	RCG	Remote ON-OFF Ground
2	P-OK-2	Power OK Signal(TTL Signal)
3	RC	Remote ON-OFF
4	P-OK-GND-2	Power OK Ground
5	GND	PV/PC Mode Choose Ground
6	Mode	PV/PC Mode Choose
7	P-OK	Power OK Signal(Relay Contact)
8	CS+	Current Sharing Signal+
9	P-OK GND	Power OK Ground
10	CS-	Current Sharing Signal-

※Control Pin No. Assignment (CN2) : HRS DF11-8DP-2DS or equivalent

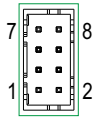

Mating Housing	HRS DF11-8DS or equivalent
Terminal	HRS DF11-8SC or equivalent

Pin No.	Function	Description
1	12V AUXG	Auxiliary output GND
2	12V AUX+	Auxiliary output+
3	NC	
4	NC	
5	PV/PC+	PV/PC adjust+
6	PV/PC-	PV/PC adjust-
7	NC	
8	NC	

Note: NC pins, please keep open circuit and do not connect to other pins/signals.

※LED status indication

LED	LED Signal	Description
Green LED normal		Power supply working normally
Green LED slow flash (Cycle 1.4S)		Standby power supply (Remote off)
Red LED of flash (Cycle 200mS)		Power OVP, output voltage too low
Red LED slow flash (Cycle 1.4S)		NTC fault, power OTP, temperature switch action
Red LED normal		Power fan fault
Red LED of flash (Cycle 200mS) Green LED of flash		Line fault, CN2 pin 7/8 signal abnormal

※AC Input Terminal Pin No. Assignment

Pin No.	Assignment	Diagram	Maximum mounting torque
1	AC/L		18Kgf-cm
2	AC/N		
3	FG \perp		

※DC Output Terminal Pin No. Assignment

Pin No.	Assignment	Diagram	Maximum mounting torque
1	V-		18Kgf-cm
2	V+		

■ Installation Manual

Please refer to : <http://www.meanwell.com/manual.html>