

# ø25mm TWS Series

Control Units

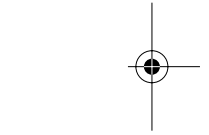

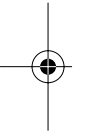

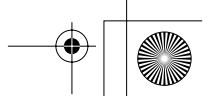
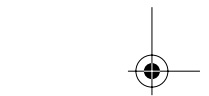

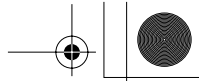



IDEC IZUMI CORPORATION













## ø25 TWS Series Control Units (Selection Guide)

Function	Pushbutton				
	Flush	Extended	Extended with Half Shroud	Extended with Full Shroud	Mushroom
Category	Momentary/Maintained				
Shape					
Type	ABS1 AOS1	ABS2 AOS2	ABGS2 AOGS2	ABFS2 AOFS2	ABS3 AOS3
Page	9	9	9	9	10

Function	Pushbutton			
	Mushroom with Full Shroud	Mushroom Pushlock Turn Reset	Mushroom Push Turn Lock	Mushroom Push-Pull
Category	Momentary/Maintained			
Shape				
Type	ABGS3 AOGS3	AVS3	AJS3	AYS3
Page	10	10	10	11





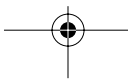

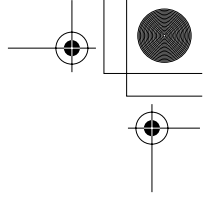
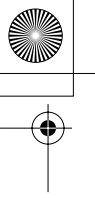



Function	Pushbutton			
	Square Flush	Square Extended	Square Twin Momentary	Square Twin Maintained
Category	Momentary/Maintained			
Shape				
Type	UBQS1 UOQS1	UBQS2	UWQN1	UWQN2
Page	11	11	12	12











Function	Pilot Light (LED/Incandescent)				
	Dome	Square (Marking) (Plastic Bezel)	Square (Marking) (Metal Bezel)	Rectangular (Marking) (Plastic Bezel)	Dome Push-to-Check
Category					
Shape					
Type	APS1	UPQS1B	UPQMS1B	UPQS4B	APS1*PN
Page	13	13	13	13	13





## TWS Series Control Units (Selection Guide) ø25

Function	Illuminated Pushbutton (LED/Incandescent)				
Category	Extended (Non-marking)	Extended with Half Shroud (Non-marking)	Extended with Full Shroud (Non-marking)	ø35mm Mushroom (Non-marking)	Mushroom Pushlock Turn Reset
Shape	 	 	 	 	 
Type	ALS2 AOLS2	ALGS2 AOLGS2	ALFS2 AOLFS2	ALS3 AOLS3	AVLS3
Page	15	16	17	18	18

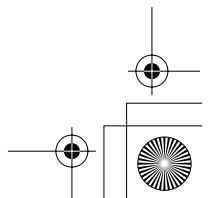
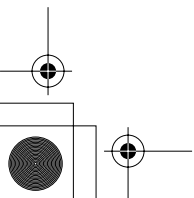
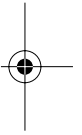
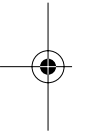

Function	Illuminated Pushbutton (LED/Incandescent)	Selector Switch			Illuminated Selector Switch (LED/Incandescent)
Category	Square Flush (Marking)	Knob	Lever	Key	Knob
Shape	 	 	 	 	 
Type	ULQS1B UOLQS1B	ASS	ASS*L	ASS*K	ASLS
Page	19	21	22	23	24



# ø25 TWS series Control Units

## Highly reliable heavy-duty type control units Suitable for industrial use

- HW-C contact blocks are used.
- Degree of protection: IP65 (IEC 60529)
- UL and CSA approved, EN compliant

Safety Standards	File No. or Organization
UL 	UL Listing File No. E68961
CSA 	File No. LR21451
EN EN60947-1 EN60947-5-1	 TÜV Rheinland

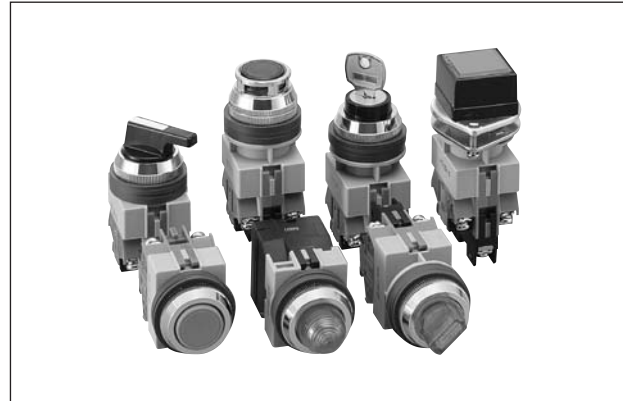

## Specifications and Ratings

### Contact Ratings

Contact Block	Rated Insulation Voltage	600V
	Rated Continuous Current	10A
	Contact Ratings by Utilization Category IEC 60947-5-1	AC-15 (A600) DC-13 (P600)

### Characteristics

#### • Contact Ratings by Utilization Category

Operational Voltage		24V	48V	50V	110V	220V	440V
Operational Current	AC 50/60 Hz	AC-12 Control of resistive loads and solid state loads	10A	—	10A	10A	6A 2A
		AC-15 Control of electromagnetic loads (> 72 VA)	10A	—	7A	5A	3A 1A
	DC	DC-12 Control of resistive loads and solid state loads	8A	4A	—	2.2A	1.1A —
		DC-13 Control of electromagnets	4A	2A	—	1.1A	0.6A —

Minimum applicable load: 3V AC/DC, 5 mA (applicable range may vary with operating conditions and load types)

For the control units listed below, the rated current (load switching current) is reduced to a half of the rated operational current of the contact block. The rated insulation voltage (600V) and the rated thermal current (10A) remain unchanged.

- Selector switches and illuminated selector switches with contact code 2R, 3S, 4S, or 4R.

### HW-C (Contact Block)

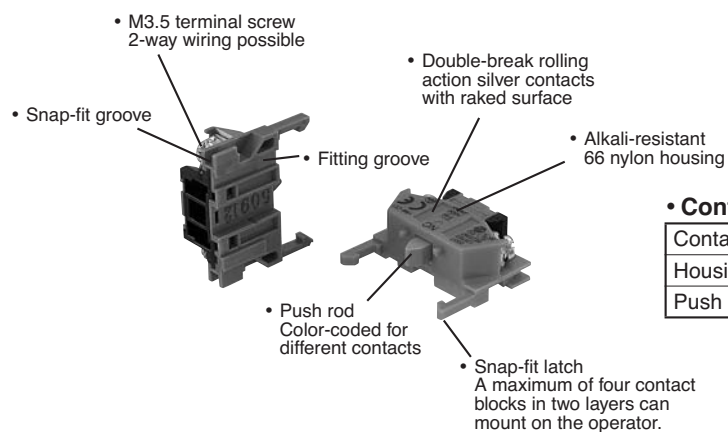

#### • Contact Block Types

Contact	NO	NC	NO (early make)	NC (late break)
Housing	Blue	Purple red	Blue	Purple red
Push Rod	Green	Red	Black	White

Note: BS type contact block is used for square twin pushbuttons UWQN1 and UWQN2.

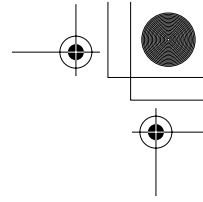
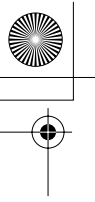
**TWS Series Control Units** ø25**Specifications**

Operating Temperature	-25 to +50°C (no freezing)
Operating Humidity	45 to 85% RH (no condensation)
Contact Resistance	50 mΩ maximum (initial value)
Insulation Resistance	100 MΩ minimum (500V DC megger)
Dielectric Strength	Between live and dead metal parts: 2,500V AC, 1 minute (Full voltage type illuminated units: 2,000V AC, 1 minute)
Vibration Resistance	Operating extremes: 5 to 55 Hz, amplitude 0.5 mm
Shock Resistance	Damage limits: 1,000 m/s <sup>2</sup> Operating extremes: 100 m/s <sup>2</sup>
Mechanical Life (minimum operations)	Pushbuttons, Illuminated pushbuttons Momentary: 5,000,000 Others: 500,000 Pushlock turn reset: 250,000 Selector switches: 500,000 Key selector switches: 500,000 Illuminated selector switches: 500,000
Electrical Life (minimum operations)	Pushbuttons: 500,000 *1 Illuminated pushbuttons: 500,000 *1 Pushlock turn reset: 250,000 *1 Square twin maintained: 500,000 *2 Selector switches: 500,000 *3 Key selector switches: 500,000 *3 Illuminated selector switches: 250,000 *3 Others: 500,000 *1 *1 Switching frequency 1,800 operations/h, duty ratio 40% *2 Switching frequency 900 operations/h, duty ratio 40% *3 Switching frequency 1,200 operations/h, duty ratio 40%

**LED Illuminated Unit Specifications**

Unit	Color Code ②	Input Type	Operating Voltage	LED Lamp		
				Lamp Base	Type No.	Voltage
Pilot Light Illuminated Pushbutton Illuminated Selector Switch	A: amber G: green PW: pure white R: red S: blue W: white Y: yellow	Full Voltage	6V AC/DC	BA9S/13	LSTD-6②	6V AC/DC ±10%
			12V AC/DC		LSTD-1②	12V AC/DC ±10%
			24V AC/DC		LSTD-2②	24V AC/DC ±10%
		Transformer	100/110V AC/DC 115V AC/DC 120V AC/DC 200/220V AC/DC 230V AC/DC 240V AC/DC 380V AC/DC 400/440V AC/DC (50/60 Hz)	BA9S/13	LSTD-6②	6V AC/DC ±10%
			DC-DC Converter		110V DC	LSTD-6②

**Incandescent Illuminated Unit Specifications**

Unit	Color Code ②	Input Type	Operating Voltage	Incandescent Lamp		
				Lamp Base	Type No.	Rating
Pilot Light Illuminated Pushbutton Illuminated Selector Switch	A: amber C: clear G: green R: red S: blue W: white	Full Voltage	6V AC/DC	BA9S/13	LS-6	1W (6.3V)
			12V AC/DC		LS-8	1W (18V)
			24V AC/DC		LS-3	1W (30V)
		Transformer	100/110V AC/DC 115V AC/DC 120V AC/DC 200/220V AC/DC 230V AC/DC 240V AC/DC 380V AC/DC 400/440V AC/DC 480V AC/DC (50/60 Hz)	BA9S/13	LS-6	1W (6.3V)

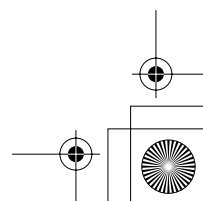
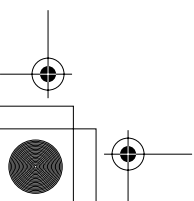

## ø25 TWS Series Control Units

### LED Lamp Ratings (LSTD Type)

Type No.	LSTD-6 <sup>②</sup>	LSTD-1 <sup>②</sup>	LSTD-2 <sup>②</sup>
Lamp Base	BA9S/13		
Rated Voltage	6V AC/DC	12V AC/DC	24V AC/DC
Voltage Range	6V AC/DC ±10%		
Current Draw	AC	A, R, W, Y: 17 mA, G, PW, S: 8 mA	11 mA
	DC	A, R, W, Y: 14 mA, G, PW, S: 5.5 mA	10 mA
Color Code <sup>②</sup>	A (amber), G (green), PW (pure white), R (red), S (blue), W (white), Y (yellow)		
Lamp Base Color	Same as illumination color		
Voltage Marking	Die stamped on the base		
Life (reference value)	Approx. 50,000 hours (The luminance is reduced to 50% the initial intensity when used on complete DC.)		
Internal Circuit	A, R, W, Y		
	G, PW, S		

### Incandescent Lamp Ratings (LS Type)

Type No.	LS-6	LS-8	LS-2	LS-3
Lamp Base	BA9S/13			
Rated Voltage	6V AC/DC	12V AC/DC	18V AC/DC	24V AC/DC
Wattage	1W (6.3V)	1W (18V)	1W (24V)	1W (30V)
Voltage Marking	Die stamped on the base			
Life (reference value)	Approx. 1,000 hours minimum (mean value when used on the rated voltage)			

### Mounting Hole Layout

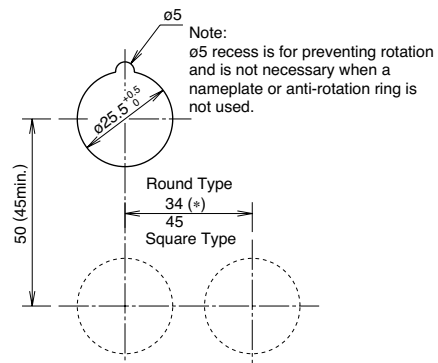

Note: The minimum mounting centers are applicable to switches with one layer of contact blocks (two contact blocks). When two layers of contact blocks are mounted, determine the minimum mounting centers in consideration of convenience for wiring.

- ø35mm mushroom: 35 mm minimum
- Mushroom with shroud: 42 mm minimum
- 2-position, 3-position lever type selector switch: 42 mm minimum
- 4-position, 5-position lever type selector switch: 50 mm minimum

### Degree of Protection

Type No.	Unit	NEMA ICS 6-110	IEC 60529
A****	Pushbuttons, pilot lights, illuminated pushbuttons, and selector switches	Type 1, 2, 3, 3R, 4, 5, 12, 13	IP65
	Illuminated selector switches and key selector switches	Type 1, 2, 3R, 5, 12, 13	IP54
U****	Square pushbuttons, square pilot lights, and square illuminated pushbuttons	Type 1, 2	IP40

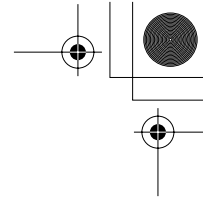
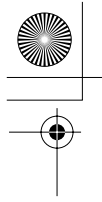

## TWS Series Control Units (Ordering Information) ø25

### Ordering Information

#### Standard Units

- Specify an operator or lens color code in the Type No.
- Full voltage type illuminated units are not supplied with a lamp. Order LED or incandescent lamps separately. Transformer and DC-DC converter type illuminated units contain an LED or incandescent lamp.
- All standard units are UL, CSA, EN, and TÜV approved (except DC-DC converter type).
- Terminal covers, nameplates, and accessories are ordered separately.

#### Terminal Cover

- When a terminal cover is required, order an applicable terminal cover referring to page 29.

The Type No. development charts shown below can be used to specify control units other than those listed on the following pages.

#### Pushbuttons

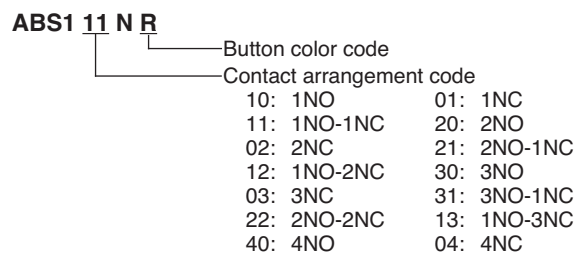

- Note:
- Push-pull type AYS3 can have a maximum of two contact blocks.

#### Pilot Lights

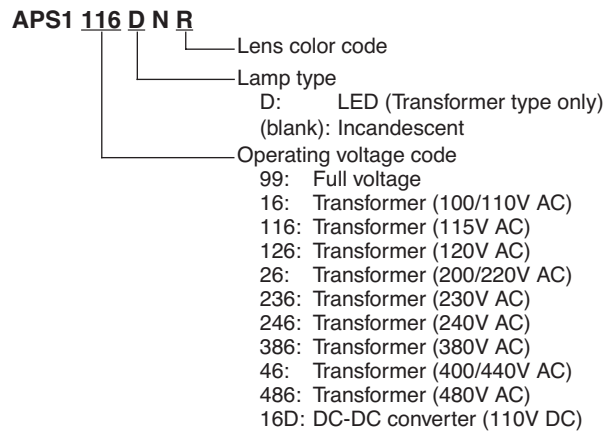

- Note:
- Full voltage type is not supplied with a lamp.
  - Transformer and DC-DC converter types contain an LED lamp (LSTD-6②) or incandescent lamp (LS-6).

#### Illuminated Pushbuttons

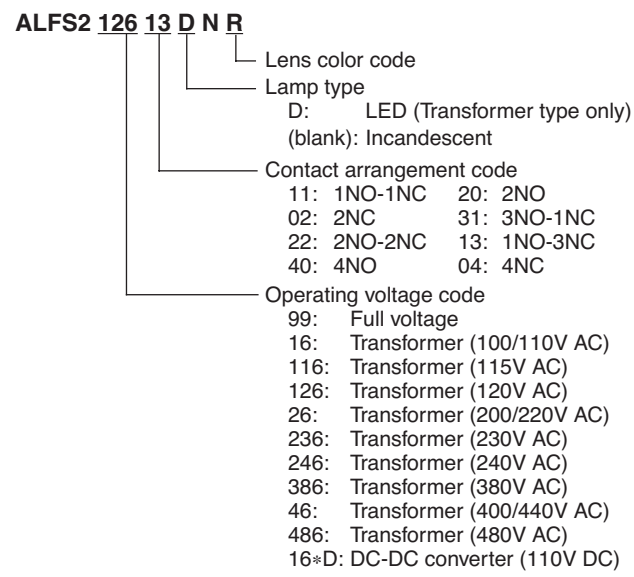

- Note:
- Full voltage type is not supplied with a lamp.
  - Transformer and DC-DC converter types contain an LED lamp (LSTD-6②) or incandescent lamp (LS-6).

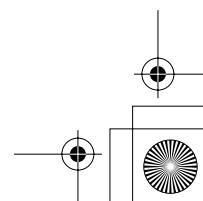
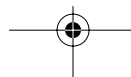
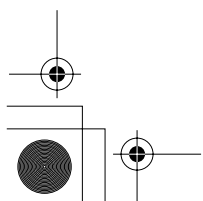

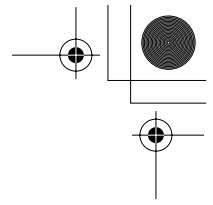
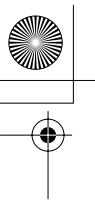

## ø25 TWS Series Control Units (Ordering Information)

### Selector Switch

ASS 2 L 11 N

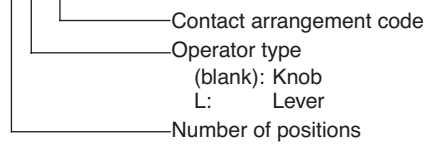

Note:

- See pages 26 to 28 for contact arrangement codes.

### Key Selector Switch

ASS 2 K 20 N B

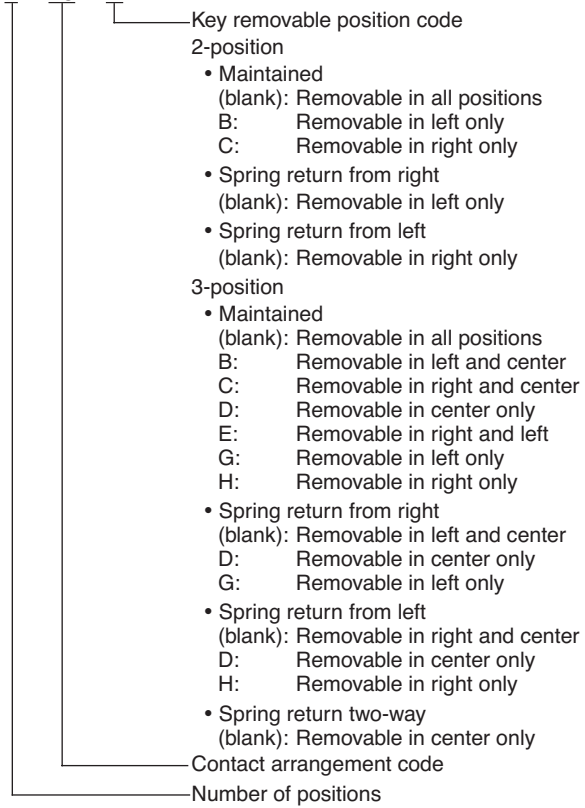

Note:

- See page 26 to 28 for contact arrangement codes.
- The key cannot be removed in the return position.

### Illuminated Selector Switch

ASLS 2 16 22 D N R

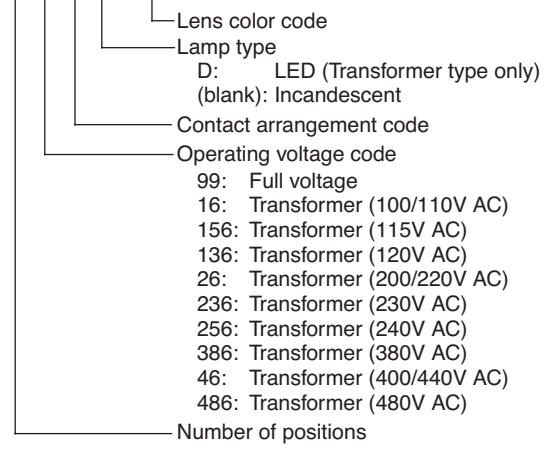





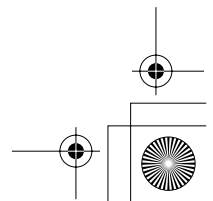
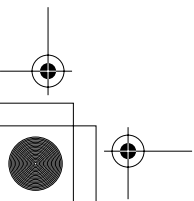
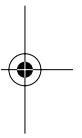
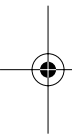



Note:

- Full voltage type is not supplied with a lamp.
- Transformer type contains an LED lamp (LSTD-6<sup>2</sup>) or incandescent lamp (LS-6).
- See pages 26 to 28 for contact arrangement codes.

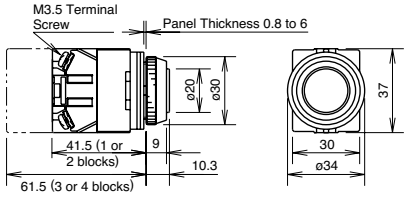

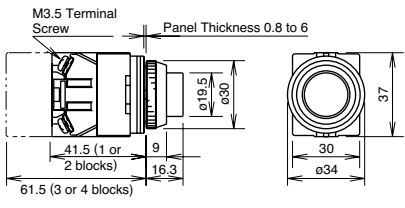
## TWS Series Pushbuttons ø25

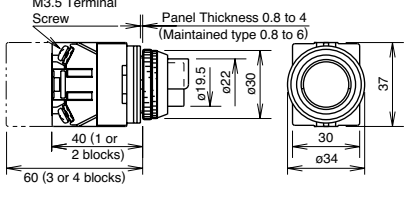

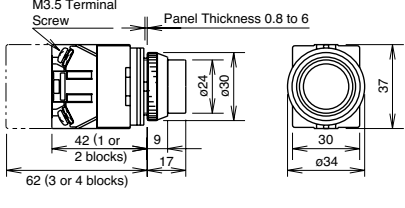



### Flush / Extended Types

Shape	Operation Type	Contact	Type No.	① Button Color Code	Dimensions (mm)					
Flush ABS1 AOS1    	Momentary	1NO	ABS110N①	Black (B), green (G), and red (R) buttons are supplied with each unit as standard.						
		1NC	ABS101N①							
		1NO-1NC	ABS111N①							
		2NO	ABS120N①							
		2NC	ABS102N①							
		2NO-2NC	ABS122N①							
	Maintained	1NO	AOS110N①	Specify S, W, or Y when a blue, white, or yellow button is required.		Note: The depth behind the panel of the maintained type is 1.5mm longer than the momentary type.				
		1NC	AOS101N①							
		1NO-1NC	AOS111N①							
		2NO	AOS120N①							
		2NC	AOS102N①							
		2NO-2NC	AOS122N①							
		Extended ABS2 AOS2    	Momentary				1NO	ABS210N①	Specify a button color code in place of ① in the Type No.  B: black G: green R: red S: blue W: white Y: yellow	
							1NC	ABS201N①		
1NO-1NC	ABS211N①									
2NO	ABS220N①									
2NC	ABS202N①									
2NO-2NC	ABS222N①									
Maintained	1NO		AOS210N①	Note: The depth behind the panel of the maintained type is 1.5mm longer than the momentary type.						
	1NC		AOS201N①							
	1NO-1NC		AOS211N①							
	2NO		AOS220N①							
	2NC		AOS202N①							
	2NO-2NC		AOS222N①							
	Extended with Half Shroud ABGS2 AOGS2    		Momentary		1NO	ABGS210N①	Specify a button color code in place of ① in the Type No.  B: black G: green R: red S: blue W: white Y: yellow			
					1NC	ABGS201N①				
1NO-1NC		ABGS211N①								
2NO		ABGS220N①								
2NC		ABGS202N①								
2NO-2NC		ABGS222N①								
Maintained		1NO	AOGS210N①	Note: The depth behind the panel of the maintained type is 1.5mm longer than the momentary type.						
		1NC	AOGS201N①							
		1NO-1NC	AOGS211N①							
		2NO	AOGS220N①							
		2NC	AOGS202N①							
		2NO-2NC	AOGS222N①							
		Extended with Full Shroud ABFS2 AOFS2    	Momentary		1NO	ABFS210N①			Specify a button color code in place of ① in the Type No.  B: black G: green R: red S: blue W: white Y: yellow	
					1NC	ABFS201N①				
1NO-1NC	ABFS211N①									
2NO	ABFS220N①									
2NC	ABFS202N①									
2NO-2NC	ABFS222N①									
Maintained	1NO		AOFS210N①	Note: The depth behind the panel of the maintained type is 1.5mm longer than the momentary type.						
	1NC		AOFS201N①							
	1NO-1NC		AOFS211N①							
	2NO		AOFS220N①							
	2NC		AOFS202N①							
	2NO-2NC		AOFS222N①							

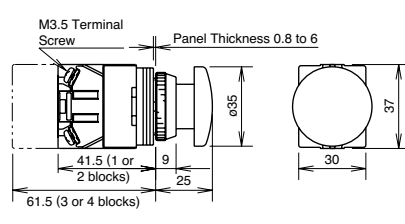
- Specify a button color code in place of ① in the Type No.
- Round bezel and shroud (metal): Chrome-plated
- Pushbuttons with one or three contact blocks contain a dummy block.
- Other contact arrangements are also available. See page 7.

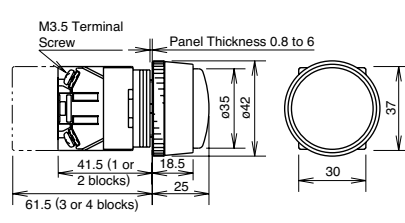
## ø25 TWS Series Pushbuttons

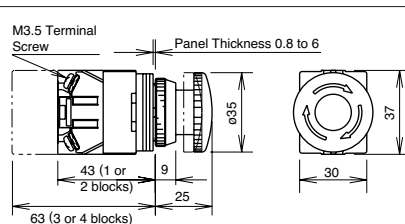
### Mushroom / Pushlock Turn Reset / Push Turn Lock Types

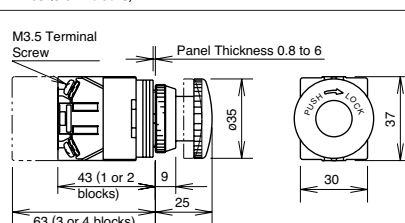



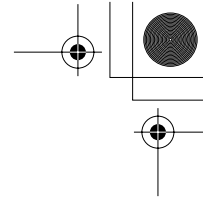
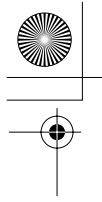

Shape	Operation Type	Contact	Type No.	① Button Color Code	Dimensions (mm)
Mushroom ABS3 AOS3 	Momentary	1NO	ABS310N①	Specify a button color code in place of ① in the Type No.  B: black G: green R: red S: blue W: white Y: yellow	 <p>Note: The depth behind the panel of the maintained type is 1.5mm longer than the momentary type.</p>
		1NC	ABS301N①		
		1NO-1NC	ABS311N①		
		2NO	ABS320N①		
		2NC	ABS302N①		
	Maintained	1NO	AOS310N①		
		1NC	AOS301N①		
		1NO-1NC	AOS311N①		
		2NO	AOS320N①		
		2NC	AOS302N①		
Mushroom with Full Shroud ABGS3 AOGS3 	Momentary	1NO	ABGS310N①	B: black G: green R: red S: blue W: white Y: yellow	 <p>Note: The depth behind the panel of the maintained type is 1.5mm longer than the momentary type.</p>
		1NC	ABGS301N①		
		1NO-1NC	ABGS311N①		
		2NO	ABGS320N①		
		2NC	ABGS302N①		
	Maintained	2NO-2NC	ABGS322N①		
		1NO	AOGS310N①		
		1NC	AOGS301N①		
		1NO-1NC	AOGS311N①		
		2NO	AOGS320N①		
Pushlock Turn Reset AVS3 	Momentary	1NO	AVS310N①	R: red Y: yellow	
		1NC	AVS301N①		
		1NO-1NC	AVS311N①		
		2NO	AVS320N①		
		2NC	AVS302N①		
		2NO-2NC	AVS322N①		
Push Turn Lock AJS3 	Momentary	1NO	AJS310N①	B: black G: green R: red Y: yellow	
		1NC	AJS301N①		
		1NO-1NC	AJS311N①		
		2NO	AJS320N①		
		2NC	AJS302N①		
		2NO-2NC	AJS322N①		

- Specify a button color code in place of ① in the Type No.
  - Round bezel (metal): Chrome-plated
  - Pushbuttons with one or three contact blocks contain a dummy block.
  - Other contact arrangements are also available. See page 7.
  - **Pushlock Turn Reset:** Button is maintained when pressed and is reset when turned clockwise.
- Note: AVS3 cannot be used as emergency stop switches. When emergency stop switches are required, use XW or HW series emergency stop switches (ISO 13850 and IEC 60947-5-5 compliant).
- **Push Turn Lock:** Button is locked when turned clockwise in the depressed position and is reset when turned counterclockwise.



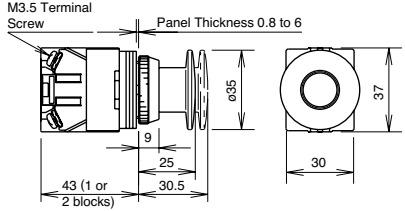

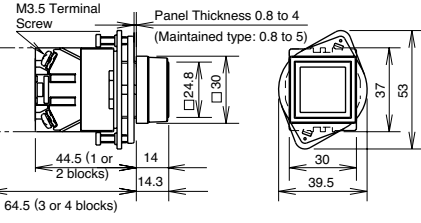

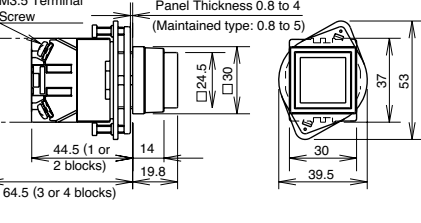



## TWS Series Pushbuttons ø25

### Push-Pull / Square Flush / Square Extended Types

Shape	Operation Type	Contact	Type No.	① Button Color Code	Dimensions (mm)	
 	Maintained	1NO	AYS3110N①	B: black G: green R: red Y: yellow		
		1NC	AYS3101N①			
		1NO-1NC	AYS3111N①			
		2NO	AYS3120N①			
		2NC	AYS3102N①			
 	Momentary	1NO	UBQS110N①	B: black G: green R: red S: blue Y: yellow		
		1NC	UBQS101N①			
		1NO-1NC	UBQS111N①			
		2NO	UBQS120N①			
		2NC	UBQS102N①			
	Maintained	2NO-2NC	UBQS122N①			Note: The depth behind the panel of the maintained type is 1.5mm longer than the momentary type.
		1NO	UOQS110N①			
		1NC	UOQS101N①			
		1NO-1NC	UOQS111N①			
		2NO	UOQS120N①			
 	Momentary	1NO	UBQS210N①			
		1NC	UBQS201N①			
		1NO-1NC	UBQS211N①			
		2NO	UBQS220N①			
		2NC	UBQS202N①			
2NO-2NC	UBQS222N①					

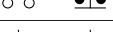
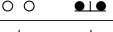
- Specify a button color code in place of ① in the Type No.
- Round bezel (metal): Chrome-plated
- Square bezel (plastic): Black
- Pushbuttons with one or three contact blocks contain a dummy block.
- Other contact arrangements are also available. See page 7.
- **Push-Pull:** Button is maintained in both depressed and reset positions. Up to 2 contact blocks (1 layer) can be mounted on AYS31 push-pull switches.

#### • Contact Statuses of Push-Pull Switch

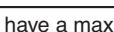
Contact	AYS31	
	Push	Pull
1NO		
1NC		
1NO-1NC		
2NO		
2NC		

• Note: Push-pull switch can have a maximum of two contact blocks.



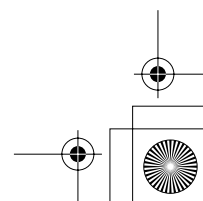
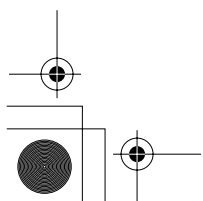
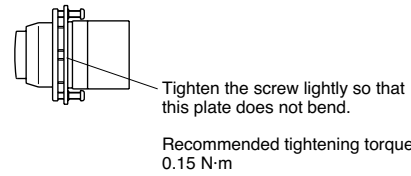

#### • Panel Mounting of Square Types

1. Tighten the square bezel to the operator and position the ring correctly.
2. Lightly tighten the screw to secure the pushbutton onto the panel.



## ø25 TWS Series Pushbuttons

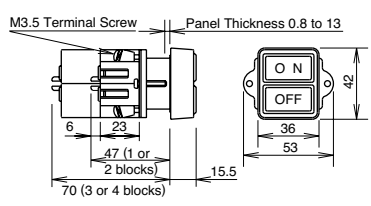
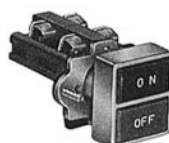

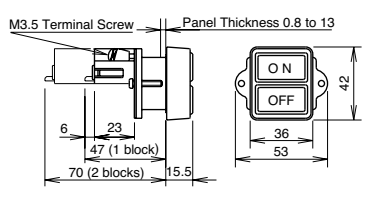







### Square Twin Types

Shape	Contact	Type No.	Button Color	Dimensions (mm)	
Square Twin (Momentary) UWQN1  	ON	OFF	ON: Black OFF: Red		
	1NO	1NO			UWQN11010
	1NO	1NC			UWQN11001
Square Twin (Maintained) UWQN2  	2NO	2NC	UWQN12002		
	1NO		UWQN21000		
	1NC		UWQN20100		
	1NO-1NC		UWQN21100		
	2NO		UWQN22000		
	2NC	UWQN20200			

- **Square Twin (Momentary):** Two independent momentary switches are contained in one unit, each operated by ON or OFF button. With the ø30 adapter removed from the sleeve, the unit can mount in a ø25.5mm mounting hole for the ø25 series.
- **Square Twin (Maintained):** The contact operates when ON button is pressed and is maintained in the depressed position. The button is reset by pressing the OFF button. With the ø30 adapter removed from the sleeve, the unit can mount in a ø25.5mm mounting hole for the ø25 series.

## TWS Series Pilot Lights ø25

### Dome / Square / Rectangular (Marking) Types

Shape	Lamp	Input Type	Type No.	② Lens/LED Color Code	③ Operating Voltage Code
Dome APS1  	Without Lamp	Full Voltage	APS199N②	A, C, G, R, S, W, Y	Specify an operating voltage code in place of ③ in the Type No. 16: 100/110V AC 116: 115 AC 126: 120V AC 26: 200/220V AC 236: 230V AC 246: 240V AC 386: 380V AC 46: 400/440V AC 486: 480V AC
	LED	Transformer	APS1③DN②	A, G, PW, R, S, W, Y	
		DC-DC Converter*	APS116DDN②		
Incandescent	Transformer	APS1N③②	A, C, G, R, S, W		
Square (Marking) UPQS1B (Plastic Bezel)  	Without Lamp	Full Voltage	UPQS1B99N②	A, G, R, S, W, Y	
	LED	Transformer	UPQS1B③DN②	A, G, PW, R, S, W, Y	
	Incandescent	Transformer	UPQS1B③N②	A, G, R, S, W	
Square (Marking) UPQMS1B (Metal Bezel)  	Without Lamp	Full Voltage	UPQMS1B99N②	A, G, R, S, W, Y	
	LED	Transformer	UPQMS1B③DN②	A, G, PW, R, S, W, Y	
	Incandescent	Transformer	UPQMS1B③N②	A, G, R, S, W	
Rectangular (Marking) UPQS4B (Plastic Bezel)  	Without Lamp	Full Voltage	UPQS4B99N②	A, G, R, S, W	
	Incandescent	Transformer	UPQS4B③N②		
Push-to-Check APS1*PN  	Without Lamp	Full Voltage	APS199PN②	A, C, G, R, S, W	
	Incandescent	Transformer	APS1③PN②		

- Color Code  
Specify a lens/LED color code in place of ② in the Type No.  
A: amber, C: clear, G: green, PW: pure white, R: red, S: blue, W: white, Y: yellow
- Specify an operating voltage code in place of ③ in the Type No.
- Full voltage types do not contain a lamp. Order LED or incandescent lamps separately. For lamps, see page 35.
- LED illuminated transformer and DC-DC converter types contain an LED lamp (LSTD-6②, rated voltage 6V AC/DC).
- Incandescent illuminated transformer types contain an incandescent lamp (LS-6, rated voltage 6V AC/DC).
- Round bezel (metal): Chrome-plated  
Square bezel (plastic): Black  
Square bezel (metal): Chrome-plated
- \* DC-DC converter types are not approved by UL, CSA, and TÜV, and not CE compliant (operating voltage 90 to 140V DC).
- The lamp of push-to-check pilot light is not connected to the contact terminal. To connect, refer to the circuit diagram example below.

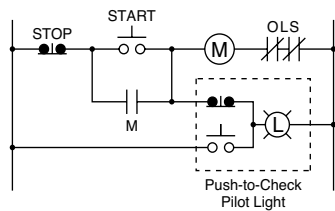

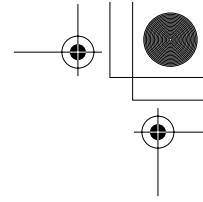
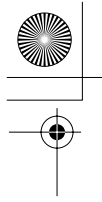

## ø25 TWS Series Pilot Lights

### Dimensions

#### • Dome APS1

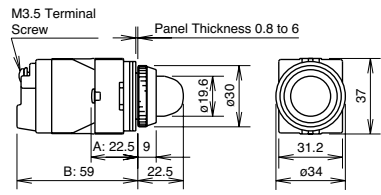

A: Full voltage type  
B: Transformer type

#### • Square (Marking Type) UPQS1B (Plastic Bezel)

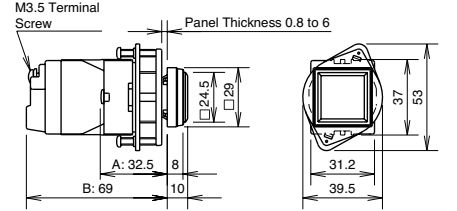

Marking Plate Size: □21.2x11 mm, 2 plates included

A: Full voltage type  
B: Transformer type

#### • Square (Marking Type) UPQMS1B (Metal Bezel)

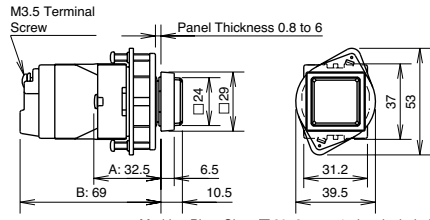

Marking Plate Size: □20x21 mm, 1 plate included

A: Full voltage type  
B: Transformer type

#### • Rectangular (Marking Type) UPQS4B

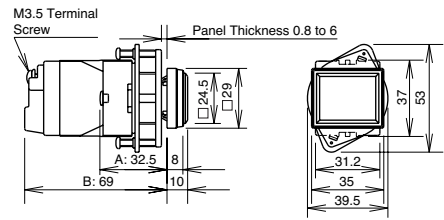

Marking Plate Size: 27.2x21.2x11 mm, 2 plates included

A: Full voltage type  
B: Transformer type

#### • Push-to-Check APS1+PN

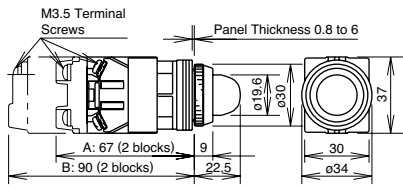

A: Full voltage type  
B: Transformer type

All dimensions in mm.

#### • Terminal Wiring (Bottom View)

Arrows indicate access directions for wiring.

Full Voltage Type

Transformer Type  
DC-DC Converter Type

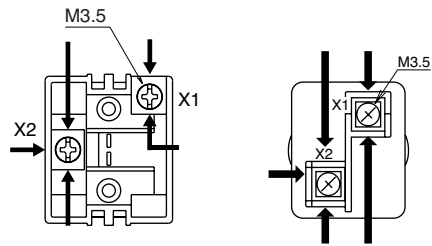

#### • Panel Mounting of Square and Rectangular Types

1. Tighten the square or rectangular bezel to the operator and position the ring correctly.
2. Lightly tighten the screw to secure the pilot light onto the panel.

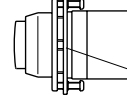

Tighten the screw lightly so that this plate does not bend.

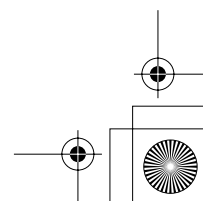
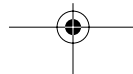
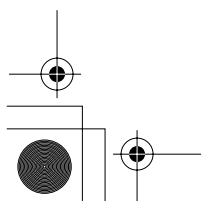

Recommended tightening torque:  
0.15 N·m

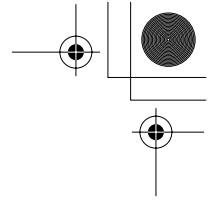
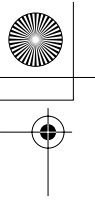



## TWS Series Illuminated Pushbuttons ø25

### Round Extended Illuminated Pushbuttons

Shape	Operation Type	Lamp	Input Type	Contact	Type No.		
 Round Extended ALS2 AOLS2  	Momentary	Without Lamp	Full Voltage	1NO-1NC	ALS29911N <sup>②</sup>		
				2NO	ALS29920N <sup>②</sup>		
				2NO-2NC	ALS29922N <sup>②</sup>		
				LED	Transformer	1NO-1NC	ALS2 <sup>③</sup> 11DN <sup>②</sup>
						2NO	ALS2 <sup>③</sup> 20DN <sup>②</sup>
						2NO-2NC	ALS2 <sup>③</sup> 22DN <sup>②</sup>
		DC-DC Converter*	1NO-1NC		ALS21611DDN <sup>②</sup>		
			2NO		ALS21620DDN <sup>②</sup>		
			2NO-2NC		ALS21622DDN <sup>②</sup>		
		Incandescent	Transformer	1NO-1NC	ALS2 <sup>③</sup> 11N <sup>②</sup>		
				2NO	ALS2 <sup>③</sup> 20N <sup>②</sup>		
				2NO-2NC	ALS2 <sup>③</sup> 22N <sup>②</sup>		
	Maintained			Without Lamp	Full Voltage	1NO-1NC	AOLS29911N <sup>②</sup>
						2NO	AOLS29920N <sup>②</sup>
						2NO-2NC	AOLS29922N <sup>②</sup>
		LED	Transformer			1NO-1NC	AOLS2 <sup>③</sup> 11DN <sup>②</sup>
						2NO	AOLS2 <sup>③</sup> 20DN <sup>②</sup>
						2NO-2NC	AOLS2 <sup>③</sup> 22DN <sup>②</sup>
			DC-DC Converter*	1NO-1NC	AOLS21611DDN <sup>②</sup>		
				2NO	AOLS21620DDN <sup>②</sup>		
				2NO-2NC	AOLS21622DDN <sup>②</sup>		
		Incandescent	Transformer	1NO-1NC	AOLS2 <sup>③</sup> 11N <sup>②</sup>		
				2NO	AOLS2 <sup>③</sup> 20N <sup>②</sup>		
				2NO-2NC	AOLS2 <sup>③</sup> 22N <sup>②</sup>		

• **Color Code and Operating Voltage Code**

Without Lamp	LED Illuminated Type	Incandescent Illuminated Type	③ Operating Voltage Code
② Lens Color Code	② Lens/LED Color Code	② Lens Color Code	
Specify a lens color code in place of ② in the Type No.	Specify a lens/LED color code in place of ② in the Type No.	Specify a lens color code in place of ② in the Type No.	Specify an operating voltage code in place of ③ in the Type No.
A: amber C: clear G: green R: red S: blue W: white Y: yellow	A: amber G: green PW: pure white R: red S: blue W: white Y: yellow	A: amber C: clear G: green R: red S: blue W: white	16: 100/110V AC 116: 115V AC 126: 120V AC 26: 200/220V AC 236: 230V AC 246: 240V AC 386: 380V AC 46: 400/440V AC 486: 480V AC

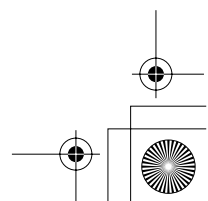
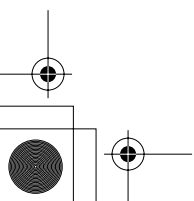

- Full voltage types do not contain a lamp. Order LED or incandescent lamps separately. For lamps, see page 35.
- LED illuminated transformer and DC-DC converter types contain an LED lamp (LSTD-6<sup>②</sup>, rated voltage 6V AC/DC).
- Incandescent illuminated transformer types contain an incandescent lamp (LS-6, rated voltage 6V AC/DC).
- Round bezel (metal): Chrome-plated
- Other contact arrangements are also available. See page 7.
- \* DC-DC converter types are not approved by UL, CSA, and TÜV, and not CE compliant (operating voltage 90 to 140V DC).

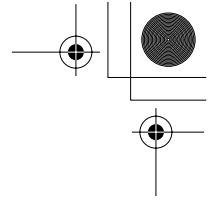
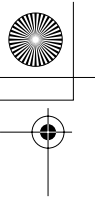



## ø25 TWS Series Illuminated Pushbuttons

### Round Extended with Half Shroud Illuminated Pushbuttons

Shape	Operation Type	Lamp	Input Type	Contact	Type No.
Round Extended with Half Shroud ALGS2 AOLGS2    	Momentary	Without Lamp	Full Voltage	1NO-1NC	ALGS29911N②
				2NO	ALGS29920N②
				2NO-2NC	ALGS29922N②
				1NO-1NC	ALGS2③11DN②
				2NO	ALGS2③20DN②
				2NO-2NC	ALGS2③22DN②
		LED	Transformer	1NO-1NC	ALGS21611DDN②
				2NO	ALGS21620DDN②
				2NO-2NC	ALGS21622DDN②
			DC-DC Converter*	1NO-1NC	ALGS2③11N②
				2NO	ALGS2③20N②
				2NO-2NC	ALGS2③22N②
	Maintained	Without Lamp	Full Voltage	1NO-1NC	AOLGS29911DN②
				2NO	AOLGS29920DN②
				2NO-2NC	AOLGS29922DN②
				1NO-1NC	AOLGS2③11DN②
		LED	Transformer	2NO	AOLGS2③20DN②
				2NO-2NC	AOLGS2③22DN②
			DC-DC Converter*	1NO-1NC	AOLGS21611DDN②
				2NO	AOLGS21620DDN②
Incandescent	Transformer	2NO-2NC	AOLGS2③22N②		
		1NO-1NC	AOLGS2③11N②		
		2NO	AOLGS2③20N②		
		2NO-2NC	AOLGS2③22N②		

#### • Color Code and Operating Voltage Code

Without Lamp	LED Illuminated Type	Incandescent Illuminated Type	③ Operating Voltage Code
② Lens Color Code	② Lens/LED Color Code	② Lens Color Code	
Specify a lens color code in place of ② in the Type No.	Specify a lens/LED color code in place of ② in the Type No.	Specify a lens color code in place of ② in the Type No.	Specify an operating voltage code in place of ③ in the Type No.
A: amber C: clear G: green R: red S: blue W: white Y: yellow	A: amber G: green PW: pure white R: red S: blue W: white Y: yellow	A: amber C: clear G: green R: red S: blue W: white	16: 100/110V AC 116: 115V AC 126: 120V AC 26: 200/220V AC 236: 230V AC 246: 240V AC 386: 380V AC 46: 400/440V AC 486: 480V AC

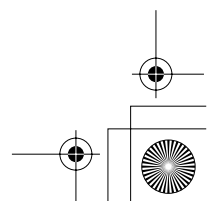
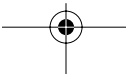
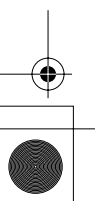

- Full voltage types do not contain a lamp. Order LED or incandescent lamps separately. For lamps, see page 35.
- LED illuminated transformer and DC-DC converter types contain an LED lamp (LSTD-6②, rated voltage 6V AC/DC).
- Incandescent illuminated transformer types contain an incandescent lamp (LS-6, rated voltage 6V AC/DC).
- Round bezel (metal): Chrome-plated
- Other contact arrangements are also available. See page 7.
- \* DC-DC converter types are not approved by UL, CSA, and TÜV, and not CE compliant (operating voltage 90 to 140V DC).

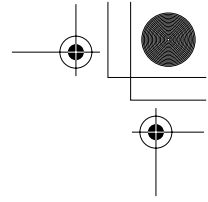
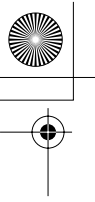



## TWS Series Illuminated Pushbuttons ø25

### Round Extended with Full Shroud Illuminated Pushbuttons

Shape	Operation Type	Lamp	Input Type	Contact	Type No.		
Round Extended with Full Shroud ALFS2 AOLFS2    	Momentary	Without Lamp	Full Voltage	1NO-1NC	ALFS29911N <sup>②</sup>		
				2NO	ALFS29920N <sup>②</sup>		
				2NO-2NC	ALFS29922N <sup>②</sup>		
				LED	Transformer	1NO-1NC	ALFS2 <sup>③</sup> 11DN <sup>②</sup>
						2NO	ALFS2 <sup>③</sup> 20DN <sup>②</sup>
						2NO-2NC	ALFS2 <sup>③</sup> 22DN <sup>②</sup>
		DC-DC Converter*	1NO-1NC	ALFS21611DDN <sup>②</sup>			
			2NO	ALFS21620DDN <sup>②</sup>			
			2NO-2NC	ALFS21622DDN <sup>②</sup>			
		Incandescent	Transformer	1NO-1NC	ALFS2 <sup>③</sup> 11N <sup>②</sup>		
				2NO	ALFS2 <sup>③</sup> 20N <sup>②</sup>		
				2NO-2NC	ALFS2 <sup>③</sup> 22N <sup>②</sup>		
	Maintained			Without Lamp	Full Voltage	1NO-1NC	AOLFS29911N <sup>②</sup>
						2NO	AOLFS29920N <sup>②</sup>
						2NO-2NC	AOLFS29922N <sup>②</sup>
		LED	Transformer			1NO-1NC	AOLFS2 <sup>③</sup> 11DN <sup>②</sup>
						2NO	AOLFS2 <sup>③</sup> 20DN <sup>②</sup>
						2NO-2NC	AOLFS2 <sup>③</sup> 22DN <sup>②</sup>
	DC-DC Converter*	1NO-1NC	AOLFS21611DDN <sup>②</sup>				
		2NO	AOLFS21620DDN <sup>②</sup>				
		2NO-2NC	AOLFS21622DDN <sup>②</sup>				
	Incandescent	Transformer	1NO-1NC	AOLFS2 <sup>③</sup> 11N <sup>②</sup>			
			2NO	AOLFS2 <sup>③</sup> 20N <sup>②</sup>			
			2NO-2NC	AOLFS2 <sup>③</sup> 22N <sup>②</sup>			

• **Color Code and Operating Voltage Code**

Without Lamp	LED Illuminated Type	Incandescent Illuminated Type	③ Operating Voltage Code
② Lens Color Code	② Lens/LED Color Code	② Lens Color Code	
Specify a lens color code in place of ② in the Type No.	Specify a lens/LED color code in place of ② in the Type No.	Specify a lens color code in place of ② in the Type No.	Specify an operating voltage code in place of ③ in the Type No.
A: amber C: clear G: green R: red S: blue W: white Y: yellow	A: amber G: green PW: pure white R: red S: blue W: white Y: yellow	A: amber C: clear G: green R: red S: blue W: white	16: 100/110V AC 116: 115V AC 126: 120V AC 26: 200/220V AC 236: 230V AC 246: 240V AC 386: 380V AC 46: 400/440V AC 486: 480V AC



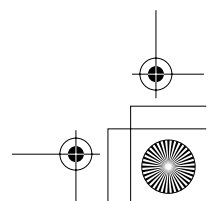
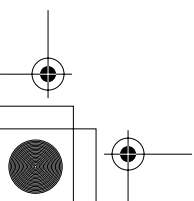

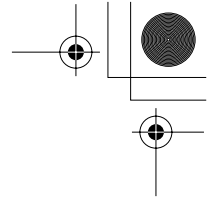
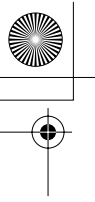
- Full voltage types do not contain a lamp. Order LED or incandescent lamps separately. For lamps, see page 35.
- LED illuminated transformer and DC-DC converter types contain an LED lamp (LSTD-6<sup>②</sup>, rated voltage 6V AC/DC).
- Incandescent illuminated transformer types contain an incandescent lamp (LS-6, rated voltage 6V AC/DC).
- Round bezel (metal): Chrome-plated
- Other contact arrangements are also available. See page 7.
- \* DC-DC converter types are not approved by UL, CSA, and TÜV, and not CE compliant (operating voltage 90 to 140V DC).





## ø25 TWS Series Illuminated Pushbuttons

### Mushroom / Mushroom Pushlock Turn Reset Illuminated Pushbuttons

Shape	Operation Type	Lamp	Input Type	Contact	Type No.
ø35mm Mushroom ALS3 AOLS3  	Momentary	Without Lamp	Full Voltage	1NO-1NC	ALS39911N②
				2NO	ALS39920N②
				2NO-2NC	ALS39922N②
		Incandescent	Transformer	1NO-1NC	ALS3③11N②
				2NO	ALS3③20N②
	Maintained	Without Lamp	Full Voltage	1NO-1NC	AOLS39911N②
				2NO	AOLS39920N②
				2NO-2NC	AOLS39922N②
		Incandescent	Transformer	1NO-1NC	AOLS3③11N②
				2NO	AOLS3③20N②
Mushroom Pushlock Turn Reset AVLS3  	Without Lamp	Full Voltage	1NO-1NC	AVLS39911NR	
			2NO	AVLS39920NR	
			2NO-2NC	AVLS39922NR	
		LED	Transformer	1NO-1NC	AVLS3③11DNR
				2NO	AVLS3③20DNR
				2NO-2NC	AVLS3③22DNR
	Incandescent	Transformer	1NO-1NC	AVLS3③11NR	
			2NO	AVLS3③20NR	
			2NO-2NC	AVLS3③22NR	
			2NO-2NC	AVLS3③22NR	

#### • Color Code and Operating Voltage Code

Without Lamp / LED Illuminated Type	Incandescent Illuminated Type	③ Operating Voltage Code
② Lens/LED Color Code	② Lens Color Code	
Specify a lens/LED color code in place of ② in the Type No.	Specify a lens color code in place of ② in the Type No.	Specify an operating voltage code in place of ③ in the Type No.
A: amber G: green R: red S: blue W: white	A: amber G: green R: red S: blue W: white	16: 100/110V AC 116: 115V AC 126: 120V AC 26: 200/220V AC 236: 230V AC 246: 240V AC 386: 380V AC 46: 400/440V AC 486: 480V AC

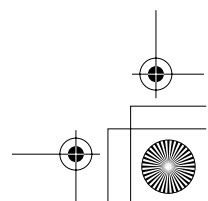
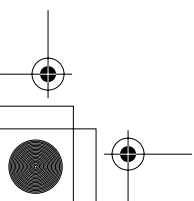

- Full voltage types do not contain a lamp. Order LED or incandescent lamps separately. For lamps, see page 35.
  - LED illuminated transformer types contain an LED lamp (LSTD-6②, rated voltage 6V AC/DC).
  - Incandescent illuminated transformer types contain an incandescent lamp (LS-6, rated voltage 6V AC/DC).
  - Round bezel (metal): Chrome-plated
  - Other contact arrangements are also available. See page 7.
  - **Pushlock Turn Reset:** Lens is maintained when pressed and is reset when turned clockwise. Red lens only.
- Note: AVLS3 pushlock turn reset switches cannot be used as emergency stop switches. When emergency stop switches are required, use XW or HW series emergency stop switches (ISO 13850 and IEC 60947-5-5 compliant).

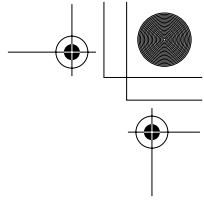
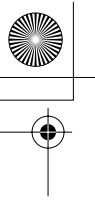



## TWS Series Illuminated Pushbuttons ø25

### Square Flush Pushbuttons

Shape	Operation Type	Lamp	Input Type	Contact	Type No.
Square Flush (Marking) ULQS1B UOLQS1B    	Momentary	Without Lamp	Full Voltage	1NO-1NC	ULQS1B9911N <sup>②</sup>
				2NO	ULQS1B9920N <sup>②</sup>
				2NO-2NC	ULQS1B9922N <sup>②</sup>
		LED	Transformer	1NO-1NC	ULQS1B <sup>③</sup> 11DN <sup>②</sup>
				2NO	ULQS1B <sup>③</sup> 20DN <sup>②</sup>
				2NO-2NC	ULQS1B <sup>③</sup> 22DN <sup>②</sup>
		Incandescent	Transformer	1NO-1NC	ULQS1B <sup>③</sup> 11N <sup>②</sup>
				2NO	ULQS1B <sup>③</sup> 20N <sup>②</sup>
				2NO-2NC	ULQS1B <sup>③</sup> 22N <sup>②</sup>
	Maintained	Without Lamp	Full Voltage	1NO-1NC	UOLQS1B9911N <sup>②</sup>
				2NO	UOLQS1B9920N <sup>②</sup>
				2NO-2NC	UOLQS1B9922N <sup>②</sup>
		LED	Transformer	1NO-1NC	UOLQS1B <sup>③</sup> 11DN <sup>②</sup>
				2NO	UOLQS1B <sup>③</sup> 20DN <sup>②</sup>
				2NO-2NC	UOLQS1B <sup>③</sup> 22DN <sup>②</sup>
Incandescent	Transformer	1NO-1NC	UOLQS1B <sup>③</sup> 11N <sup>②</sup>		
		2NO	UOLQS1B <sup>③</sup> 20N <sup>②</sup>		
		2NO-2NC	UOLQS1B <sup>③</sup> 22N <sup>②</sup>		

• **Color Code and Operating Voltage Code**

Without Lamp	LED Illuminated Type	Incandescent Illuminated Type	③ Operating Voltage Code
② Lens Color Code	② Lens/LED Color Code	② Lens Color Code	
Specify a lens color code in place of ② in the Type No.	Specify a lens/LED color code in place of ② in the Type No.	Specify a lens color code in place of ② in the Type No.	Specify an operating voltage code in place of ③ in the Type No.
A: amber G: green R: red S: blue W: white Y: yellow	A: amber G: green PW: pure white R: red S: blue W: white Y: yellow	A: amber G: green R: red S: blue W: white	16: 100/110V AC 116: 115V AC 126: 120V AC 26: 200/220V AC 236: 230V AC 246: 240V AC 386: 380V AC 46: 400/440V AC 486: 480V AC

- Full voltage types do not contain a lamp. Order LED or incandescent lamps separately. For lamps, see page 35.
- LED illuminated transformer types contain an LED lamp (LSTD-6<sup>②</sup>, rated voltage 6V AC/DC).
- Incandescent illuminated transformer types contain an incandescent lamp (LS-6, rated voltage 6V AC/DC).
- Square bezel (plastic): Black
- Other contact arrangements are also available. See page 7.

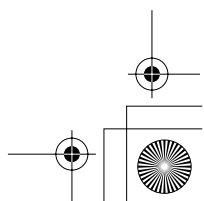
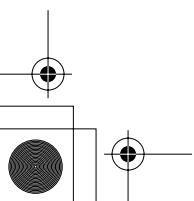

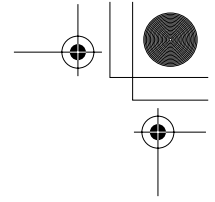
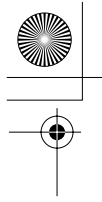

## Ø25 TWS Series Illuminated Pushbuttons

### Dimensions

#### • Round Extended ALS2 / AOLS2

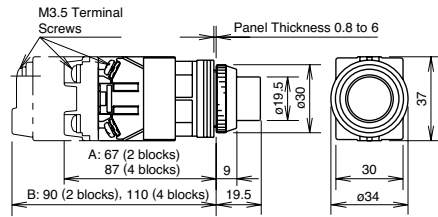

A: Full voltage type  
B: Transformer type

#### • Round Extended with Half Shroud ALGS2 / AOLGS2

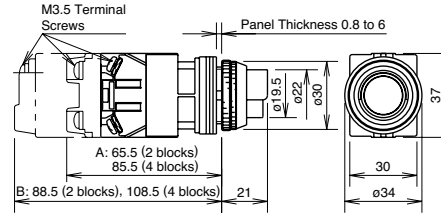

A: Full voltage type  
B: Transformer type

#### • Round Extended with Full Shroud ALFS2 / AOLFS2

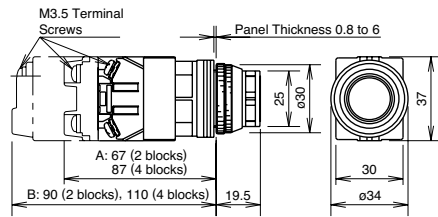

A: Full voltage type  
B: Transformer type

#### • Ø35mm Mushroom ALS3 / AOLS3

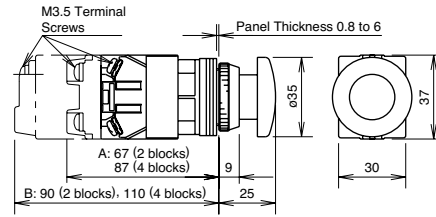

A: Full voltage type  
B: Transformer type

#### • Mushroom Pushlock Turn Reset AVLS3

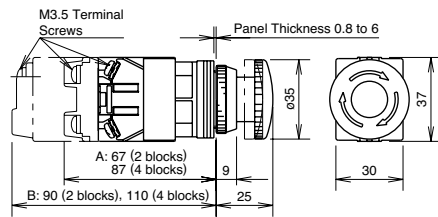

A: Full voltage type  
B: Transformer type

#### • Square Flush ULQS1B / UOLQS1B

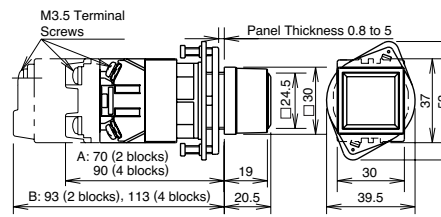

Marking Plate Size: □21.2x11 mm, 2 plates included

A: Full voltage type  
B: Transformer type

All dimensions in mm.

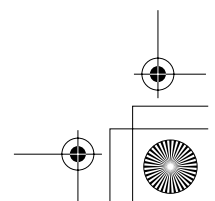
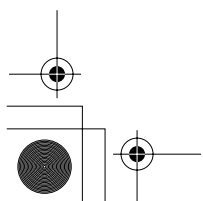

## TWS Series Selector Switches ø25

### Selector Switches (Knob Operator Type)

No. of Positions	Shape		Contact Arrangement Chart							
	Shape	ASS	Contact Block		Operator Position		Maintained	Spring Return from Right	Spring Return from Left	
	Contact Code	Mounting Position	Type	L	R					
90° 2-position	10 (1NO)	1	NO		●		ASS210N	ASS2110N	ASS2210N *	—
		2	Dummy							
	11 (1NO-1NC)	1	NO		●		ASS211N	ASS2111N	ASS2211N *	
		2	NC	●						
	20 (2NO)	1	NO		●		ASS220N	ASS2120N	ASS2220N *	
		2	NO		●					
	22 (2NO-2NC)	1	NO		●		ASS222N	ASS2122N	ASS2222N *	
		2	NC	●						
		3	NO		●					
		4	NC	●						
2R ★ (1NO-1NC)	1	NO		●		ASS22RN-118 ★	ASS212RN-118 ★	—		
	2	NC	●							
2R ★ (1NO-1NC)	1	NC	●			—	—	ASS222RN-169 ★		
	2	NO		●						
45° 3-position	20 (2NO)	1	NO	●		●	ASS320N	ASS3120N	ASS3220N	ASS3320N
		2	NO		●					
	02 (2NC)	1	NC	●			ASS302N	ASS3102N	ASS3202N	ASS3302N
		2	NC		●					
	22 (2NO-2NC)	1	NO	●			ASS322N	ASS3122N	ASS3222N	ASS3322N
		2	NO		●					
		3	NC	●						
		4	NC		●					
	40 (4NO)	1	NO	●			ASS340N	ASS3140N	ASS3240N	ASS3340N
		2	NO		●					
		3	NO	●						
		4	NO		●					
	04 (4NC)	1	NC	●			ASS304N	ASS3104N	ASS3204N	ASS3304N
		2	NC		●					
		3	NC	●						
		4	NC		●					
3S ★	1	NO	●			ASS33SN-243 ★	—	—	—	
	2	NO		●						
	3	NC			●					
	4	Dummy								
30° 5-position / 45° 4-position	4S ★	1	NC		●	●	ASS44SN-407 ★	—		
		2	NC		●					
		3	NC			●				
		4	NO			●				
	4S ★	1	NO	●			ASS44SN-411 ★	—		
		2	NC		●					
		3	NC			●				
		4	NO			●				
	3S ★	1	NO	●			ASS43SN-461 ★	—		
		2	NC		●					
		3	NC			●				
		4	Dummy							
4S ★	1	NO	●			—	ASS54SN-501 ★			
	2	NC		●						
	3	NC			●					
	4	NO			●					

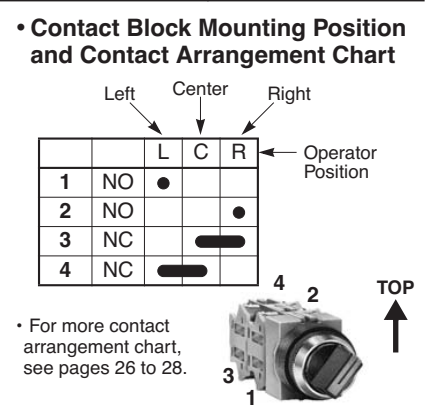

- On the 2-position selector switches marked with \* above, the contact operation is reversed as follows.
 

●	●
●	●

 →
 

●	●
●	●
- On the contact arrangement marked with ★ in the table above, the rated current (load switching current) is reduced to a half of the rated current of the contact block. The rated insulation voltage and the rated thermal current remain unchanged.
- Selector switches with one or three contact blocks contain a dummy block.
- Knob operator: White indicator on black knob

## ø25 TWS Series Selector Switches

### Selector Switches (Lever Operator Type)

No. of Positions	Shape		Contact Arrangement Chart				ASS* <sub>L</sub>		
	Mounting Position	Type	L	C	R	Maintained	Spring Return from Right	Spring Return from Left	
90° 2-position	10 (1NO)	1 NO				ASS2L10N	ASS21L10N	ASS22L10N *	
		2 Dummy							
	11 (1NO-1NC)	1 NO				ASS2L11N	ASS21L11N	ASS22L11N *	
		2 NC							
	20 (2NO)	1 NO				ASS2L20N	ASS21L20N	ASS22L20N *	
		2 NO							
	22 (2NO-2NC)	1 NO				ASS2L22N	ASS21L22N	ASS22L22N *	
		2 NC							
		3 NO							
		4 NC							
2R ★ (1NO-1NC)	1 NO				ASS2L2RN-118 ★	ASS21L2RN-118 ★	—		
2R ★ (1NO-1NC)	2 NC				—	—	ASS22L2RN-169 ★		
45° 3-position	20 (2NO)	1 NO				ASS3L20N	ASS31L20N	ASS32L20N	ASS33L20N
		2 NO							
	02 (2NC)	1 NC				ASS3L02N	ASS31L02N	ASS32L02N	ASS33L02N
		2 NC							
	22 (2NO-2NC)	1 NO				ASS3L22N	ASS31L22N	ASS32L22N	ASS33L22N
		2 NO							
		3 NC							
		4 NC							
	40 (4NO)	1 NO				ASS3L40N	ASS31L40N	ASS32L40N	ASS33L40N
		2 NO							
		3 NO							
		4 NO							
	04 (4NC)	1 NC				ASS3L04N	ASS31L04N	ASS32L04N	ASS33L04N
		2 NC							
		3 NC							
		4 NC							
3S ★	1 NO				ASS3L3SN-243 ★	—	—	—	
	2 NO								
	3 NC								
	4 Dummy								
30° 5-position / 45° 4-position	4S ★	1 NC				ASS4L4SN-407 ★	—	—	
		2 NC							
		3 NC							
		4 NO							
	4S ★	1 NO				ASS4L4SN-411 ★	—	—	
		2 NC							
		3 NC							
		4 NO							
	3S ★	1 NO				ASS4L3SN-461 ★	—	—	
		2 NC							
		3 NC							
		4 Dummy							
4S ★	1 NO				—	ASS5L4SN-501 ★	—		
	2 NC								
	3 NC								
	4 NO								

#### • Contact Block Mounting Position and Contact Arrangement Chart

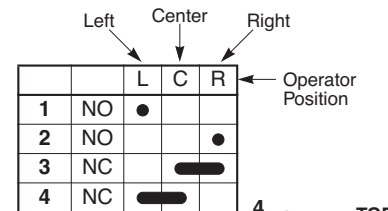

• For more contact arrangement chart, see pages 26 to 28.

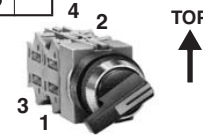

• On the 2-position selector switches marked with \* above, the contact operation is reversed as follows.

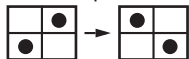

• On the contact arrangement marked with ★ in the table above, the rated current (load switching current) is reduced to a half of the rated current of the contact block. The rated insulation voltage and the rated thermal current remain unchanged.

• Selector switches with one or three contact blocks contain a dummy block.

• Lever operator: White indicator on black lever

## TWS Series Selector Switches ø25

### Key Selector Switches

No. of Positions	Shape		Contact Arrangement Chart											
	Shape	ASS*K	10	11	20	22	2R ★	2R ★	20	02	22	40	04	3S ★
	Contact Code	Contact Block		Operator Position		Maintained	Spring Return from Right	Spring Return from Left						
		Mounting Position	Type	L	R	Diagram	Diagram	Diagram						
90° 2-position	10 (1NO)	1	NO		●	ASS2K10N	ASS21K10N	ASS22K10N *						
		2	Dummy											
	11 (1NO-1NC)	1	NO		●	ASS2K11N	ASS21K11N	ASS22K11N *						
		2	NC	●										
	20 (2NO)	1	NO		●	ASS2K20N	ASS21K20N	ASS22K20N *						
		2	NO		●									
	22 (2NO-2NC)	1	NO		●	ASS2K22N	ASS21K22N	ASS22K22N *						
		2	NC	●										
		3	NO		●									
	2R ★ (1NO-1NC)	1	NO		●	ASS2K2RN-118 ★	ASS21K2RN-118 ★	—						
2		NC	●											
2R ★ (1NO-1NC)	1	NC	●		—	—	ASS22K2RN-169 ★							
	2	NO		●										
45° 3-position	20 (2NO)	1	NO	●		ASS3K20N	ASS31K20N	ASS32K20N	ASS33K20N					
		2	NO		●									
	02 (2NC)	1	NC		●	ASS3K02N	ASS31K02N	ASS32K02N	ASS33K02N					
		2	NC		●									
	22 (2NO-2NC)	1	NO	●		ASS3K22N	ASS31K22N	ASS32K22N	ASS33K22N					
		2	NO		●									
		3	NC		●									
	40 (4NO)	1	NO		●	ASS3K40N	ASS31K40N	ASS32K40N	ASS33K40N					
		2	NO		●									
		3	NO		●									
		4	NO		●									
	04 (4NC)	1	NC		●	ASS3K04N	ASS31K04N	ASS32K04N	ASS33K04N					
		2	NC		●									
		3	NC		●									
3S ★	1	NO	●		ASS3K3SN-243 ★	—	—	—						
	2	NO		●										
	3	NC		●										
	4	Dummy												

- On the spring-returned types, the key can be released only from the maintained position. On the maintained types, the key can be released from every position. Key retained positions are also available. See page 8.
- On the 2-position selector switches marked with \* above, the contact operation is reversed as follows.
- On the contact arrangement marked with ★ in the table above, the rated current (load switching current) is reduced to a half of the rated current of the contact block. The rated insulation voltage and the rated thermal current remain unchanged.
- Key selector switches with one or three contact blocks contain a dummy block.
- Cylinder cover: Black  
Round bezel (Metal): Chrome-plated

• **Contact Block Mounting Position and Contact Arrangement Chart**

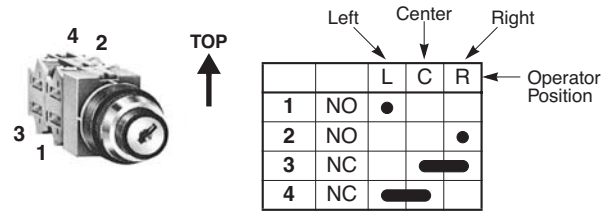

• For more contact arrangement chart, see pages 26 to 28.

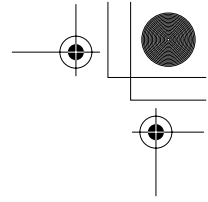
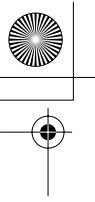

## ø25 TWS Series Illuminated Selector Switches

### Illuminated Selector Switches

#### 90° 2-position

<b>Shape</b>		ASLS							
<b>Contact Arrangement Chart</b>									
Contact Code	Contact Block		Operator Position		Lamp	Input Type	Maintained	Spring Return from Right	Spring Return from Left
	Mounting Position	Type	L	R			L	R	L
11 (1NO-1NC)	1	NO		●	Without Lamp	Full Voltage	ASLS29911N <sup>②</sup>	ASLS219911N <sup>②</sup>	ASLS229911N <sup>②</sup> *
	2	NC	●		LED	Transformer	ASLS2 <sup>③</sup> 11DN <sup>②</sup>	ASLS21 <sup>③</sup> 11DN <sup>②</sup>	ASLS22 <sup>③</sup> 11DN <sup>②</sup> *
					Incandescent	Transformer	ASLS2 <sup>③</sup> 11N <sup>②</sup>	ASLS21 <sup>③</sup> 11N <sup>②</sup>	ASLS22 <sup>③</sup> 11N <sup>②</sup> *
20 (2NO)	1	NO		●	Without Lamp	Full Voltage	ASLS29920N <sup>②</sup>	ASLS219920N <sup>②</sup>	ASLS229920N <sup>②</sup> *
	2	NO		●	LED	Transformer	ASLS2 <sup>③</sup> 20DN <sup>②</sup>	ASLS21 <sup>③</sup> 20DN <sup>②</sup>	ASLS22 <sup>③</sup> 20DN <sup>②</sup> *
					Incandescent	Transformer	ASLS2 <sup>③</sup> 20N <sup>②</sup>	ASLS21 <sup>③</sup> 20N <sup>②</sup>	ASLS22 <sup>③</sup> 20N <sup>②</sup> *
22 (2NO-2NC)	1	NO		●	Without Lamp	Full Voltage	ASLS29922N <sup>②</sup>	ASLS219922N <sup>②</sup>	ASLS229922N <sup>②</sup> *
	2	NC	●						
	3	NO		●	LED	Transformer	ASLS2 <sup>③</sup> 22DN <sup>②</sup>	ASLS21 <sup>③</sup> 22DN <sup>②</sup>	ASLS22 <sup>③</sup> 22DN <sup>②</sup> *
	4	NC	●						
				Incandescent	Transformer	ASLS2 <sup>③</sup> 22N <sup>②</sup>	ASLS21 <sup>③</sup> 22N <sup>②</sup>	ASLS22 <sup>③</sup> 22N <sup>②</sup> *	

#### • Color Code and Operating Voltage Code

Without Lamp / LED Illuminated Type	Incandescent Illuminated Type	③ Operating Voltage Code
② Lens/LED Color Code	② Lens Color Code	
Specify a lens/LED color code in place of ② in the Type No. A: amber G: green R: red S: blue W: white Y: yellow	Specify a lens color code in place of ② in the Type No. A: amber G: green R: red S: blue W: white	Specify an operating voltage code in place of ③ in the Type No. 16: 100/110V AC 156: 115V AC 136: 120V AC 26: 200/220V AC 236: 230V AC 256: 240V AC 386: 380V AC 46: 400/440V AC 486: 480V AC

• On the selector switches marked with \* above, the contact operation is reversed as follows.

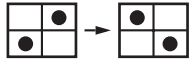

- Full voltage types do not contain a lamp. Order LED or incandescent lamps separately. For lamps, see page 35.
- LED illuminated transformer types contain an LED lamp (LSTD-6<sup>②</sup>, rated voltage 6V AC/DC).
- Incandescent illuminated transformer types contain an incandescent lamp (LS-6, rated voltage 6V AC/DC).
- Round bezel (Metal): Chrome-plated

#### • Contact Block Mounting Position and Contact Arrangement Chart

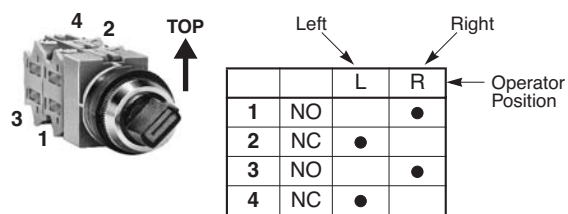

• For more contact arrangement chart, see pages 26 to 28.

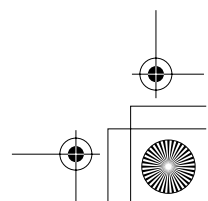
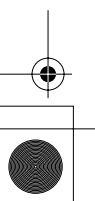

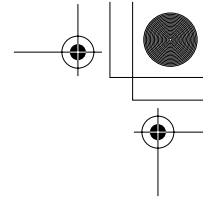
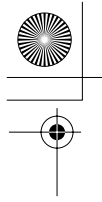

## TWS Series Illuminated Selector Switches ø25

### Illuminated Selector Switches

#### 45° 3-position

Contact Code	Contact Block		Operator Position			Lamp Input Type	Maintained	Spring Return from Right	Spring Return from left	Spring Return Two-way
	Mounting Position	Type	L	C	R					
20 (2NO)	1	NO	●			Without Lamp Full Voltage	ASLS39920N <sup>②</sup>	ASLS319920N <sup>②</sup>	ASLS329920N <sup>②</sup>	ASLS339920N <sup>②</sup>
	2	NO			●	LED Transformer	ASLS3 <sup>③</sup> 20DN <sup>②</sup>	ASLS31 <sup>③</sup> 20DN <sup>②</sup>	ASLS32 <sup>③</sup> 20DN <sup>②</sup>	ASLS33 <sup>③</sup> 20DN <sup>②</sup>
						Incandescent Transformer	ASLS3 <sup>③</sup> 20N <sup>②</sup>	ASLS31 <sup>③</sup> 20N <sup>②</sup>	ASLS32 <sup>③</sup> 20N <sup>②</sup>	ASLS33 <sup>③</sup> 20N <sup>②</sup>
02 (2NC)	1	NC		■		Without Lamp Full Voltage	ASLS39902N <sup>②</sup>	ASLS319902N <sup>②</sup>	ASLS329902N <sup>②</sup>	ASLS339902N <sup>②</sup>
	2	NC		■		LED Transformer	ASLS3 <sup>③</sup> 02DN <sup>②</sup>	ASLS31 <sup>③</sup> 02DN <sup>②</sup>	ASLS32 <sup>③</sup> 02DN <sup>②</sup>	ASLS33 <sup>③</sup> 02DN <sup>②</sup>
						Incandescent Transformer	ASLS3 <sup>③</sup> 02N <sup>②</sup>	ASLS31 <sup>③</sup> 02N <sup>②</sup>	ASLS32 <sup>③</sup> 02N <sup>②</sup>	ASLS33 <sup>③</sup> 02N <sup>②</sup>
22 (2NO-2NC)	1	NO	●			Without Lamp Full Voltage	ASLS39922N <sup>②</sup>	ASLS319922N <sup>②</sup>	ASLS329922N <sup>②</sup>	ASLS339922N <sup>②</sup>
	2	NO			●	LED Transformer	ASLS3 <sup>③</sup> 22DN <sup>②</sup>	ASLS31 <sup>③</sup> 22DN <sup>②</sup>	ASLS32 <sup>③</sup> 22DN <sup>②</sup>	ASLS33 <sup>③</sup> 22DN <sup>②</sup>
	3	NC		■		LED Transformer	ASLS3 <sup>③</sup> 22DN <sup>②</sup>	ASLS31 <sup>③</sup> 22DN <sup>②</sup>	ASLS32 <sup>③</sup> 22DN <sup>②</sup>	ASLS33 <sup>③</sup> 22DN <sup>②</sup>
	4	NC		■		Incandescent Transformer	ASLS3 <sup>③</sup> 22N <sup>②</sup>	ASLS31 <sup>③</sup> 22N <sup>②</sup>	ASLS32 <sup>③</sup> 22N <sup>②</sup>	ASLS33 <sup>③</sup> 22N <sup>②</sup>
40 (4NO)	1	NO	●			Without Lamp Full Voltage	ASLS39940N <sup>②</sup>	ASLS319940N <sup>②</sup>	ASLS329940N <sup>②</sup>	ASLS339940N <sup>②</sup>
	2	NO			●	LED Transformer	ASLS3 <sup>③</sup> 40DN <sup>②</sup>	ASLS31 <sup>③</sup> 40DN <sup>②</sup>	ASLS32 <sup>③</sup> 40DN <sup>②</sup>	ASLS33 <sup>③</sup> 40DN <sup>②</sup>
	3	NO	●			LED Transformer	ASLS3 <sup>③</sup> 40DN <sup>②</sup>	ASLS31 <sup>③</sup> 40DN <sup>②</sup>	ASLS32 <sup>③</sup> 40DN <sup>②</sup>	ASLS33 <sup>③</sup> 40DN <sup>②</sup>
	4	NO			●	Incandescent Transformer	ASLS3 <sup>③</sup> 40N <sup>②</sup>	ASLS31 <sup>③</sup> 40N <sup>②</sup>	ASLS32 <sup>③</sup> 40N <sup>②</sup>	ASLS33 <sup>③</sup> 40N <sup>②</sup>
04 (4NC)	1	NC		■		Without Lamp Full Voltage	ASLS39904N <sup>②</sup>	ASLS319904N <sup>②</sup>	ASLS329904N <sup>②</sup>	ASLS339904N <sup>②</sup>
	2	NC		■		LED Transformer	ASLS3 <sup>③</sup> 04DN <sup>②</sup>	ASLS31 <sup>③</sup> 04DN <sup>②</sup>	ASLS32 <sup>③</sup> 04DN <sup>②</sup>	ASLS33 <sup>③</sup> 04DN <sup>②</sup>
	3	NC		■		LED Transformer	ASLS3 <sup>③</sup> 04DN <sup>②</sup>	ASLS31 <sup>③</sup> 04DN <sup>②</sup>	ASLS32 <sup>③</sup> 04DN <sup>②</sup>	ASLS33 <sup>③</sup> 04DN <sup>②</sup>
	4	NC		■		Incandescent Transformer	ASLS3 <sup>③</sup> 04N <sup>②</sup>	ASLS31 <sup>③</sup> 04N <sup>②</sup>	ASLS32 <sup>③</sup> 04N <sup>②</sup>	ASLS33 <sup>③</sup> 04N <sup>②</sup>

#### • Color Code and Operating Voltage Code

Without Lamp / LED Illuminated Type	Incandescent Illuminated Type	③ Operating Voltage Code
② Lens/LED Color Code	② Lens Color Code	
Specify a lens/LED color code in place of ② in the Type No. A: amber G: green R: red S: blue W: white Y: yellow	Specify a lens color code in place of ② in the Type No. A: amber G: green R: red S: blue W: white	Specify an operating voltage code in place of ③ in the Type No. 16: 100/110V AC 156: 115V AC 136: 120V AC 26: 200/220V AC 236: 230V AC 256: 240V AC 386: 380V AC 46: 400/440V AC 486: 480V AC

- Full voltage types do not contain a lamp. Order LED or incandescent lamps separately. For lamps, see page 35.
- LED illuminated transformer types contain an LED lamp (LSTD-6<sup>②</sup>, rated voltage 6V AC/DC).
- Incandescent illuminated transformer types contain an incandescent lamp (LS-6, rated voltage 6V AC/DC).
- Round bezel (Metal): Chrome-plated

#### • Contact Block Mounting Position and Contact Arrangement Chart

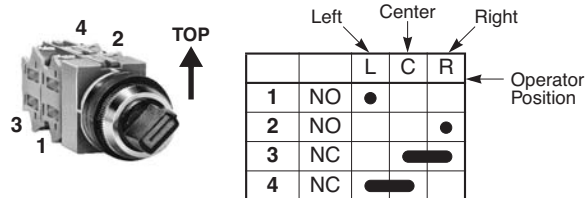

• For more contact arrangement chart, see pages 26 to 28.

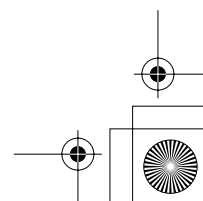
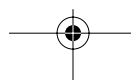
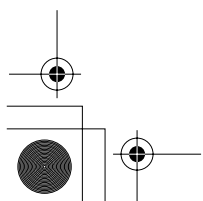

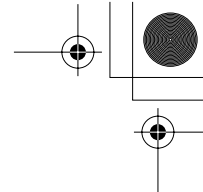
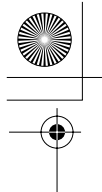

# ø25 TWS Series Selector Switch Contact Arrangement Charts

## 90° 2-position (Maintained / Spring Return)

Positions				Maintained	Spring Return from Right	Spring Return from Left		
Operator Types				Knob, Lever, Key, Illuminated				
Contact Code	Circuit No.	Mounting Position	Type	Operator Positions				
10 (1NO)	-	1	NO		•	•		
		2	Dummy					
01 (1NC)	-	1	NC	•			•	
		2	Dummy					
11 (1NO-1NC)	-	1	NO		•	•		
		2	NC	•			•	
		103	1	NC	•			•
			2	NO		•	•	
20 (2NO)	-	1	NO		•	•		
		2	NO		•	•		
02 (2NC)	-	1	NC	•			•	
		2	NC	•			•	
22 (2NO-2NC)	-	1	NO		•	•		
		2	NC	•			•	
		3	NO		•	•		
		4	NC	•			•	
	110	1	NC	•			•	
		2	NO		•	•		
		3	NC	•			•	
		4	NO		•	•		
	111	1	NO		•	•		
		2	NO		•	•		
		3	NC	•			•	
		4	NC	•			•	
117	1	NC	•			•		
	2	NO		•	•			
	3	NO		•	•			
	4	NC	•			•		
31 (3NO-1NC)	107	1	NC	•			•	
		2	NO		•	•		
		3	NO		•	•		
		4	NO		•	•		
40 (4NO)	-	1	NO		•	•		
		2	NO		•	•		
		3	NO		•	•		
		4	NO		•	•		
2R ★	-	1	NO	■				
		2	NC		■			
		1	NO			■		
		2	NC			■		
119 ★	-	1	NC	■				
		2	NO		■			
		1	NC			■		
		2	NO		■			
4R ★	120 ★	1	NO	■				
		2	NC		■			
		3	NO		■			
		4	NC	■				
	170 ★	1	NO			■		
		2	NC		■			
		3	NO		■			
		4	NC	■				
	121 ★	1	NC	■				
		2	NO		■			
		3	NC	■				
		4	NO		■			
171 ★	1	NC			■			
	2	NO		■				
	3	NC	■					
	4	NO		■				

### Contact Block Mounting Position and Contact Arrangement Chart

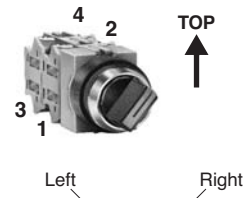

		L	R
1	NO		•
2	NC	•	
3	NO		•
4	NC	•	

• On the contact arrangement marked with ★ in the table, the rated current (load switching current) is reduced to a half of the rated current of the contact block. The rated insulation voltage and the rated thermal current remain unchanged.

### Type No. Development

• When circuit number is not required:

**ASS 2 11 N**  
 — Contact Code (1NO-1NC)  
 — 2-position

• When circuit number is required:

**ASS 2 11 N - 103**  
 — Circuit No.  
 — Contact Code (1NO-1NC)  
 — 2-position

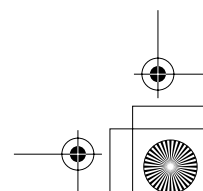
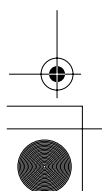

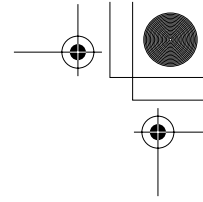
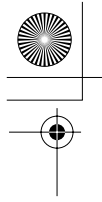

# TWS Series Selector Switch Contact Arrangement Charts ø25

## 45° 3-position (Maintained / Spring Return)

Positions	Maintained	Spring Return from Right	Spring Return from Left	Spring Return Two-way
Operator Types	Knob, Lever, Key, Illuminated			

Contact Code	Circuit No.	Mounting Position	Type	Operator Positions			
				L	C	R	
11 (1NO-1NC)	202	1	NO	•			
		2	NC	—			
	203	1	NC		—		
		2	NO			•	
	302	1	NO	•		•	
		2	NC	—			
303	1	NC		•			
	2	NO			•		
20 (2NC)	—	1	NO	•			
		2	NO			•	
301	—	1	NO			•	
		2	NO			•	
02 (2NC)	—	1	NC		—		
		2	NC	—			
		1	NC		•		
		2	NC	—			
22 (2NO-2NC)	—	1	NO	•			
		2	NO			•	
		3	NC		—		
		4	NC	—			
	210	—	1	NC		—	
			2	NO			•
			3	NC		—	
			4	NO			•
	308	—	1	NO	•		
			2	NC	—		
			3	NO	•		•
			4	NC	—		
309	—	1	NO	•			
		2	NC	—			
		3	NC		•		
		4	NO			•	
310	—	1	NC		•		
		2	NO			•	
		3	NC		•		
		4	NO			•	
31 (3NO-1NC)	206	1	NO	•			
		2	NC	—			
		3	NO	•		•	
		4	NO			•	
207	—	1	NC		—		
		2	NO			•	
		3	NO	•		•	
		4	NO			•	
13 (1NC-3NC)	212	1	NO	•			
		2	NC	—			
		3	NC		—		
		4	NC	—			
	313	—	1	NC		•	
			2	NO			•
			3	NC		•	
			4	NC	—		

Contact Code	Circuit No.	Mounting Position	Type	Operator Positions			
				L	C	R	
40 (4NO)	—	1	NO	•			
		2	NO			•	
		3	NO	•			
		4	NO			•	
305	—	1	NO	•		•	
		2	NO			•	
		3	NO	•		•	
		4	NO			•	
04 (4NC)	—	1	NC		—		
		2	NC	—			
		3	NC		—		
		4	NC	—			
	314	—	1	NC		•	
			2	NC	—		
			3	NC		•	
			4	NC	—		

### • Contact Block Mounting Position and Contact Arrangement Chart

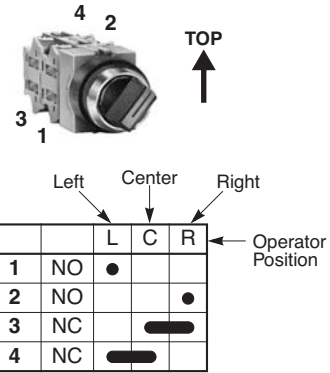

### Type No. Development

- When circuit number is not required:

**ASS 3 22 N**  
 — Contact Code (2NO-2NC)  
 — 3-position

- When circuit number is required:

**ASS 3 22 N - 210**  
 — Circuit No.  
 — Contact Code (2NO-2NC)  
 — 3-position

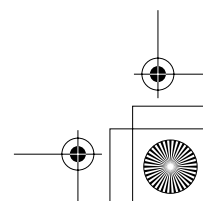
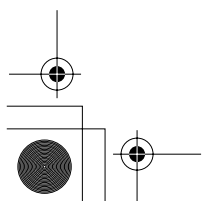

## ø25 TWS Series Selector Switch Contact Arrangement Charts

### 45° 3-position (Maintained)

Positions				Maintained		
						
Operator Types				Knob, Lever, Illuminated		
Contact Code	Circuit No.	Mounting Position	Type	Operator Positions		
				L	C	R
3S★	243★	1	NO	•		
		2	NO			•
		3	NC		•	
		4	Dummy			
4S★	233★	1	NO	•		
		2	NC		•	
		3	NO			•
		4	NO			•
4S★	234★	1	NO	•		
		2	NC		•	
		3	NC		•	
		4	NC		•	
4S★	235★	1	NC		•	
		2	NO			•
		3	NC		•	
		4	NO			•
4S★	237★	1	NO	•		
		2	NO			•
		3	NC		•	
		4	NO			•
4S★	240★	1	NC		•	
		2	NC		•	
		3	NC		•	
		4	NO			•

### 45° 4-position (Maintained)

Positions				Maintained			
							
Operator Types				Knob, Lever			
Contact Code	Circuit No.	Mounting Position	Type	Operator Positions			
				1	2	3	4
3S★	461★	1	NO	•			
		2	NC		•		
		3	NC			•	
		4	Dummy				
4S★	405★	1	NC		•		
		2	NC		•		
		3	NC			•	
		4	NC			•	
4S★	407★	1	NC		•		
		2	NC		•		
		3	NC			•	
		4	NO			•	
4S★	409★	1	NO	•			
		2	NC		•		
		3	NC			•	
		4	NC			•	
4S★	411★	1	NO	•			
		2	NC		•		
		3	NC			•	
		4	NO			•	

### 30° 5-position (Maintained)

Positions				Maintained				
								
Operator Types				Knob, Lever				
Contact Code	Circuit No.	Mounting Position	Type	Operator Positions				
				1	2	3	4	5
4S★	501★	1	NO	•				
		2	NC		•			
		3	NC			•		
		4	NO				•	

#### • Contact Block Mounting Position and Contact Arrangement Chart

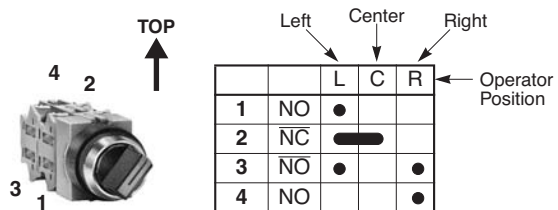

• On the contact arrangement marked with ★ in the table, the rated current (load switching current) is reduced to a half of the rated current of the contact block. The rated insulation voltage and the rated thermal current remain unchanged.

#### Type No. Development









- When circuit number is not required:

**ASS 3 4S N**  
 — Contact Code  
 — 3-position

- When circuit number is required:

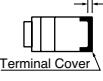
**ASS 3 4S N - 233**  
 — Circuit No.  
 — Contact Code (2NO-2NC)  
 — 3-position

## TWS Series Accessories and Replacement Parts ø25

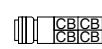
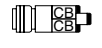
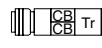
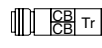
<b>Terminal Covers</b>						
Terminal Cover	<b>TW-VLC</b>	<b>HW-VL3</b>	<b>HW-VL5</b>	<b>APS-PVL</b>		
Control Unit	 44.6H x 14.1W	 37.8H x 26W	 39.1H x 15.5W	 36H x 29.4W	Use of terminal covers increases the depth by the dimensions below.	 Terminal Cover
• Pilot light APS UPQS UPQMS	Full Voltage			X	+6 mm	
	Transformer DC-DC Converter		X		+3 mm	
• Pushbutton ABS AOS ABGS AOGS ABFS AOFS AKS AVS AJS AZS ATS UTS AYS	1 contact block 	X			+3.5 mm	
	2 contact blocks 	X 2 pieces				
	3 contact blocks 	X 2 pieces				
	4 contact blocks 	X 2 pieces				
• Selector switch ASS						
• Illuminated pushbutton ALS AOLF AOLS ULOS ALGS UOLQS AOLGS AVLS ALFS ATLS	Full Voltage 			X	+3 mm	
• Illuminated selector switch ASLS	Transformer DC-DC Converter 		X		+3 mm	
• Push-to-check pilot light APS						

**• Ordering Terminal Covers**  
Terminal covers are ordered separately.  
When ordering terminal covers, specify the Type No. and required quantity.

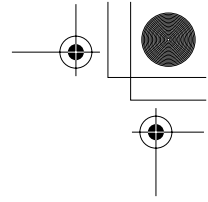
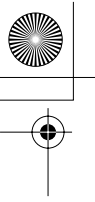

## ø25 TWS Series Accessories and Replacement Parts

### Nameplates

#### NSA, NSALO, and NFSO

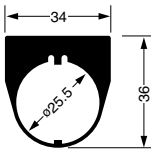
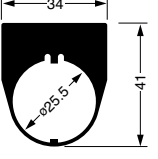
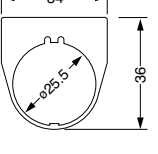
Dimensions (mm)	Legend	Material	Type No.	Ordering Type No.	Package Quantity	Description
	Blank	Aluminium 0.8 mm thick	NSA-0	NSA-0	1	• Black
				NSA-0PN10	10	
	With Legend		NSA-*	NSA-*	1	• White letters on black background
				NSA-*PN10	10	
	Blank	Aluminium 0.8 mm thick	NSALO	NSALO	1	• Black
				NSALOPN10	10	
	Blank	Stainless steel 0.8 mm thick	NFSO	NFSO	1	• Stainless steel ground color
				NFSOPN10	10	

• Specify a legend code in place of \* in the Ordering Type No.

#### Legends

Code	Legend
0	(blank)
1	ON
2	OFF
3	START
4	STOP
31	OFF-ON
35	HAND-AUTO
53	HAND-OFF-AUTO



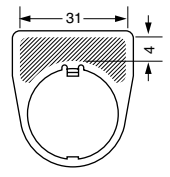
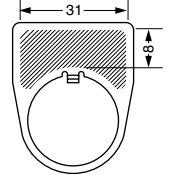



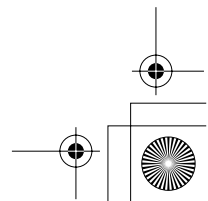
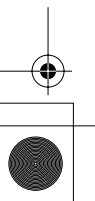



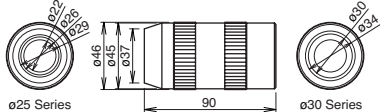

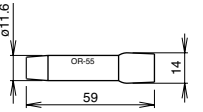
#### Example of Shape and Engraving Area

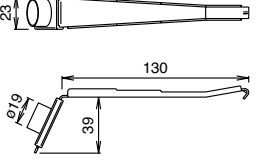
Shape	Engraving Area		Max. No. of Lines	No. of Letters on 1 Line
	Height	Width		
Standard Type (NSA/NFSO) 	4	31	1	17
Mushroom Type (NSALO) 	8	31	2	17

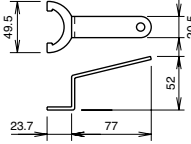
- The above example is when the letter is 3 mm tall.
- Engraving must be made within 1.5 mm from the sides.

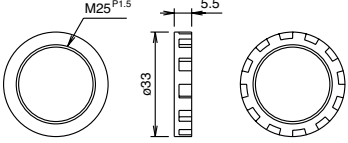
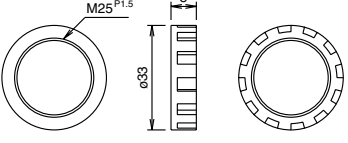

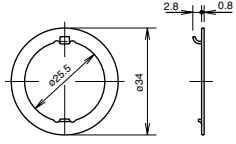

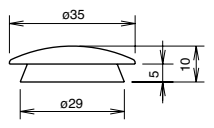

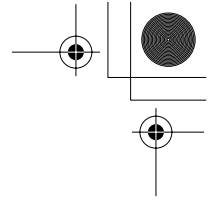
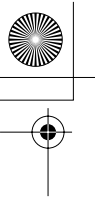



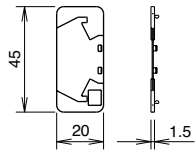

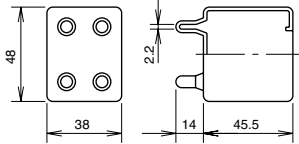
## TWS Series Accessories and Replacement Parts ø25

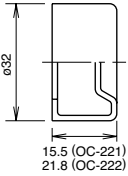
<b>Accessories</b>					
Shape	Material	Type No.	Ordering Type No.	Package Quantity	Dimensions (mm)
	Rubber	OR-12	OR-12	1	<ul style="list-style-type: none"> <li>Used to tighten the round bezel when installing the TWS control unit onto a panel.</li> </ul> 
	Rubber	OR-55	OR-55	1	<ul style="list-style-type: none"> <li>Used to install and remove LED/incandescent lamps.</li> </ul> 
	Metal/ Rubber	TW-KC1	TW-KC1	1	<ul style="list-style-type: none"> <li>Used to remove contact blocks, transformers, lenses and adapters.</li> </ul> 
	Metal	TWST-T1	TWST-T1	1	<ul style="list-style-type: none"> <li>Used to tighten the locking ring on the square control units.</li> </ul> 
	Pushbutton Illuminated Pushbutton	OG-RT1	OG-RT1PN02	2	<ul style="list-style-type: none"> <li>Used to attach square pushbuttons and illuminated pushbuttons on to the panel.</li> <li>Mounting centers are the same as round control units.</li> </ul> 
	Pilot Light	OG-RT2	OG-RT2PN02	2	<ul style="list-style-type: none"> <li>Used to attach pilot lights on to the panel.</li> <li>Mounting centers are the same as round control units.</li> </ul> 
	Metal	OGL-21	OGL-21PN10	10	<ul style="list-style-type: none"> <li>Used to prevent the operator from rotating. Generally used when using no nameplates on selector switches.</li> </ul> 
	Rubber (black)	OBS-13B	OBS-13BP05	5	<ul style="list-style-type: none"> <li>Used to plug unused ø25.5mm mounting holes.</li> </ul> 

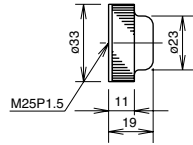

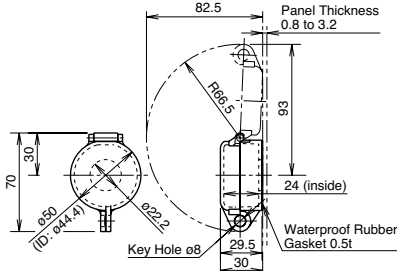

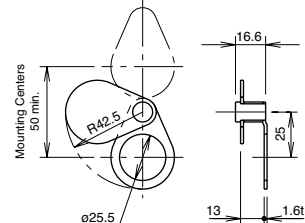

## ø25 TWS Series Accessories and Replacement Parts

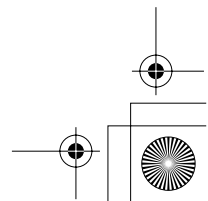
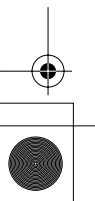
Accessories					
Shape	Material	Type No.	Ordering Type No.	Package Quantity	Dimensions (mm)
	Plastic	HW-VL1	HW-VL1PN10	10	<ul style="list-style-type: none"> <li>Used to prevent contact between adjacent lead wires when units are mounted closely. Barriers should be always used in close mounting.</li> </ul> 
 <p>For 1 layer of contact blocks (2 contact blocks)</p>	Rubber (nitril) Black	OCS-99	OCS-99	1	<ul style="list-style-type: none"> <li>Dust cover boot used for pushbuttons and selector switches.</li> <li>Temperature range: -5 to +60°C</li> <li>Black</li> </ul> 
 <p>For flush pushbuttons</p> <p>For extended pushbuttons</p>	Rubber (EPDM)	OC-221	OC-221	1	<ul style="list-style-type: none"> <li>Used to cover and protect pushbuttons where units are subject to water splash. Not suitable for outdoor use or where the units are subject to oil splash.</li> </ul> 
		OC-222	OC-222	1	
	Rubber (nitril)	OCS-11①	OCS-11①	1	<p>B (black), G (green), R (red), Y (yellow)</p> <ul style="list-style-type: none"> <li>Metallic bezels covered with rubber boot to enhance waterproof and oiltight characteristics.</li> <li>Button is installed in the cover. Remove the button from the pushbutton before using the button cover.</li> <li>Temperature range: -5 to +60°C</li> </ul> 
	Polyarylate (gasket: nitril rubber)	OLS-KL1	OLS-KL1	1	<ul style="list-style-type: none"> <li>Used to protect momentary and maintained pushbuttons, illuminated pushbuttons, knob selector switches, and key selector switches.</li> </ul> 
	Metal	OLS-C	OLS-C	1	<ul style="list-style-type: none"> <li>Used to protect flush buttons from inadvertent operation.</li> <li>Can be easily attached under the round bezel.</li> </ul> 

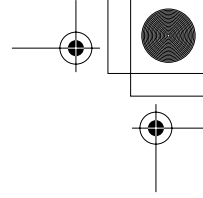
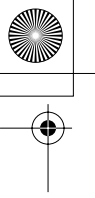
Note: Specify a button cover color code in place of ① in the Ordering Type No.



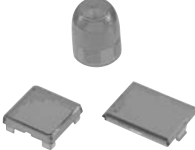





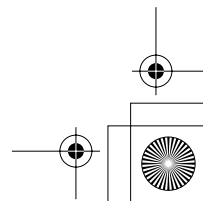
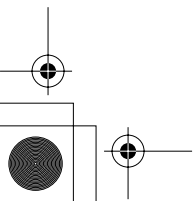

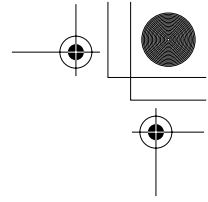
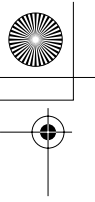



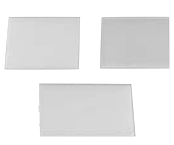

**TWS Series Accessories and Replacement Parts** ø25**Maintenance Parts**

Shape		Material	Type No.	Ordering Type No.	Package Quantity	Color Code	
	Pushbutton Pilot Light	Plastic	OGP-22①	OGP-22①PN02	2	B (black), G (green), R (red), Y (yellow), W (white) • Cannot be used for control units with half shroud or full shroud.	
	Selector Switch		OGP-33①	OGP-33①PN02			
	Pushbutton Pilot Light	Metal (chrome-plated)	OG-22	OG-22PN02	1	• Cannot be used for control units with half shroud or full shroud.	
	Selector Switch		OG-33	OG-33PN02			
	Pushbutton with Full Shroud		ABS2FN	ABS2FN			
	Mushroom with Full Shroud		ABS3GN	ABS3GN			
	Pushbutton, Illuminated Pushbutton with Half Shroud	ALS1G	ALS1G				
Illuminated Pushbutton with Full Shroud	ALS1F	ALS1F					
	Flush	Plastic	ABS1BN-①	ABS1BN-①PN05	5	B (black), G (green), R (red), S (blue), Y (yellow), W (white) • Light color	
	Extended		ABS2BN-①	ABS2BN-①PN05			
	ø35mm Mushroom		ABS3BN-①	ABS3BN-①PN02	2		
	Square Flush	Plastic	UBQS1BN-①	UBQS1BN-①PN02	2	B (black), G (green), R (red), S (blue), Y (yellow) • Light color	
	Square Extended		UBQS2BN-①	UBQS2BN-①PN02			
	Pushlock Turn Reset		AVS3BN-①	AVS3BN-①PN02			R (red), Y (yellow)
	Push-Pull		AYS3BN-①	AYS3BN-①PN02			B (black), G (green), R (red), Y (yellow)
	Dome	Plastic	APS106L-②	APS106L-②PN05	5	C (clear), G (green), R (red), S (blue)	
			APS106LD-②	APS106LD-②PN05		A (amber), W (white), Y (yellow)	
	For Square Metal Bezel Unit		UPQS306L-②	UPQS306L-②PN05		C (clear), G (green), R (red), S (blue)	
			UPQS306LD-②	UPQS306LD-②PN05		A (amber), Y (yellow)	
	Rectangular		UPQS406L-②	UPQS406L-②PN05		A (amber), C (clear), G (green), R (red), S (blue)	
	For Square Type with Plastic Bezel	Plastic	UPQS106L-②	UPQS106L-②PN05	5	C (clear), G (green), R (red), S (blue)	
			UPQS106LD-②	UPQS106LD-②PN05	5	A (amber), Y (yellow)	
	Extended	Plastic	ALS06L-②	ALS06L-②PN05	5	C (clear), G (green), R (red), S (blue)	
			ALS06LD-②	ALS06LD-②PN05		A (amber), Y (yellow), W (white)	
	Mushroom		ALS3L-②	ALS3L-②PN02	2	G (green), R (red), S (blue)	
			ALS3LD-②	ALS3LD-②PN02		A (amber), W (white)	
	Pushlock Turn Reset		AVLS3L-R	AVLS3L-RPN02			

Note: Specify a button color code or lens color code in place of ① or ② in the Ordering Type No.  
Use a clear lens for white or pure white illumination.



**ø25 TWS Series Accessories and Replacement Parts**

Maintenance Parts						
Shape	Material	Type No.	Ordering Type No.	Package Quantity	Remarks	
	Knob	Plastic	ASSHHY-①	ASSHHY-①PN02	2	B (black), G (green), R (red)
	Lever		ASSHHL-①	ASSHHL-①PN02		
	Color Insert	Plastic	TWS-HC1①	TWS-HC1①PN05	5	B (black), G (green), R (red), S (blue), Y (yellow), W (white)
	Illuminated Selector		ASLSLDY-②	ASLSLDY-②		
	ASLSDDY-②	ASLSDDY-②				
	Plastic	AKS2B-①	AKS2B-①PN05	5	B (black), R (red)	
	Plastic	ABS1B-C	ASB1B-CPN05	5	B (black), G (green), R (red), W (white), Y (yellow) • Used on flush pushbuttons to indicate a mark or a symbol engraved on the marking plate. The clear button cover holds the marking plate.	
	Plastic	TWS-0①	TWS-0①PN10	10		
	Plastic	UPQS106P-W	UPQS106P-WPN02	2	• □21.2 × 1t mm	
		UPQS306N-W	UPQS306N-WPN02		• □20 × 2t mm	
		UPQS406P-W	UPQS406P-WPN02		• 27.2 × 21.2 × 1t mm	
	1NO		HW-C10	HW-C10	1	• Housing: Blue Push rod: Green
	1NC		HW-C01	HW-C01		• Housing: Purple red Push rod: Red
	Early Make		HW-C10R	HW-C10R		• Housing: Blue Push rod: Black
	Late Break		HW-C01R	HW-C01R		• Housing: Purple red Push rod: White
			TW-DB	TW-DBPN10	10	• Used for non-illuminated units with 1NO or 1NC contact blocks.
			TW-DA1B	TW-DA1BPN02	2	• Adapter with M3.5 screws used for illuminated pushbutton or illuminated selector switch. Snaps on to the back of the contact block.
	For Key Selector Switch	Metal	TW-SK-0	TW-SK-0PN02	2	
	3.0-mm thick	Rubber	OW-22	OW-22PN10	10	• Outside diameter: ø33.8 • Inside diameter: ø25.5
	1.5-mm thick		OW-21	OW-21PN10		

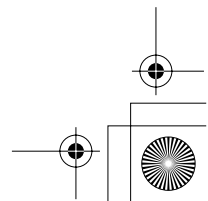
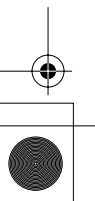

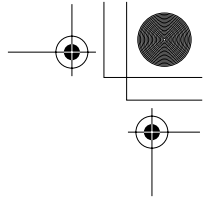
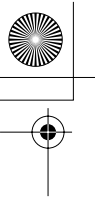







## TWS Series Accessories and Replacement Parts ø25

### Maintenance Parts

#### LED Lamps (LSTD Type)

Operating Voltage	Current Draw		Type No.	Ordering Type No.	Illumination Color Code	Package Quantity	Base
	AC	DC					
6V AC/DC ±10% 	17 mA (A, R, W, Y) 8 mA (G, PW, S)	14 mA (A, R, W, Y) 5.5 mA (G, PW, S)	LSTD-6②	LSTD-6②	Specify a color code in place of ② in the Ordering Type No.	1	BA9S/13
				LSTD-6②PN10		10	
12V AC/DC ±10% 	11 mA	10 mA	LSTD-1②	LSTD-1②	A: amber G: green PW: pure white R: red S: blue W: white Y: yellow	1	
				LSTD-1②PN10		10	
24V AC/DC ±10% 	11 mA	10 mA	LSTD-2②	LSTD-2②		1	
				LSTD-2②PN10		10	

#### Incandescent Lamps (LS Type)

Rated Operating Voltage	Lamp Ratings	Type No.	Package Quantity
6V AC/DC 	1W (6.3V)	LS-6	1
12V AC/DC 	1W (18V)	LS-8	
18V AC/DC 	1W (24V)	LS-2	
24V AC/DC 	1W (30V)	LS-3	

#### Transformer

Shape	Primary Voltage	Secondary Voltage	Type No.
Transformer Unit 	100/110V AC	5.5V	TW-T16B
	120V AC		TW-T126B
	200/220V AC		TW-T26B
	240V AC		TW-T246B

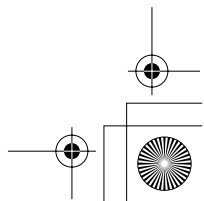
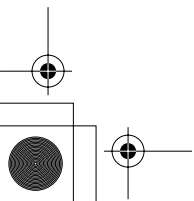

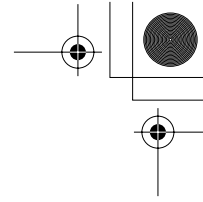
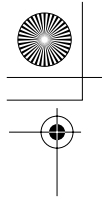

## ø25 TWS Series Instructions

### Safety Precautions

- Turn off the power to the TWS series control units before starting installation, removal, wiring, maintenance, and inspection of the products. Failure to turn power off may cause electrical shocks or fire hazard.
- To avoid a burn on your hand, use the lamp holder tool when replacing lamps.
- For wiring, use wires of a proper size to meet the voltage and current requirements. Tighten the M3.5 terminal screws to a tightening torque of 1.0 to 1.3 N·m. Failure to tighten terminal screws may cause overheating and fire.

- Use HW-C type contact blocks for the TWS series. Do not replace with or add conventional TW series contact blocks. Using a different type of contact block may lead to malfunction.

HW-C Type Contact Block

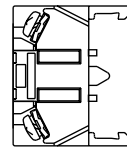

TW Type Contact Block

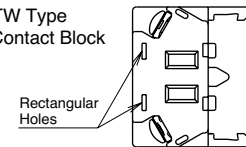

### Instructions

#### • Installation of Selector Operators

1. The shaft of each selector or illuminated selector switch has a recess to identify in which direction to install the operator. Align the operator with the recess and press in the operator.
2. Press color insert (non-illuminated type) into the operator. The color insert retains the operator.

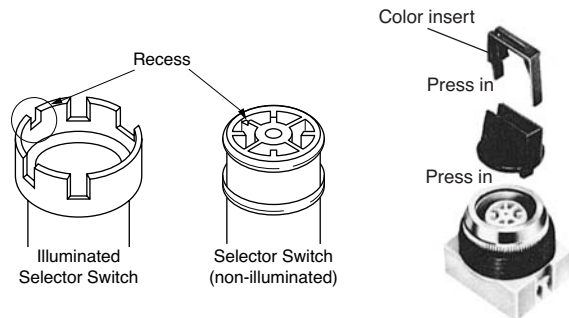

#### • Removing the Operator

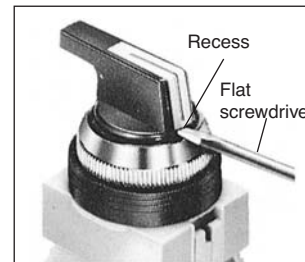

##### 1. Removing the Color Insert

Insert a flat screwdriver (4.5mm wide at maximum) into the recess of the color insert. Turn the screwdriver to push out the insert from the operator.

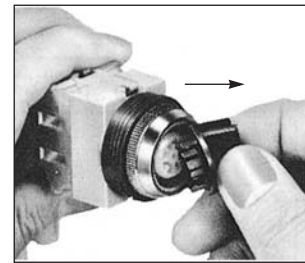

##### 2. Removing the Operator (Non-illuminated)

Push the operator sideways as shown in the left photo to remove the operator.

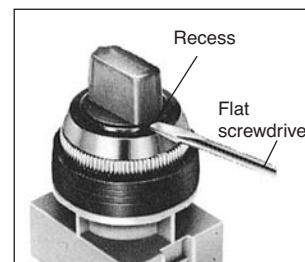

##### 3. Removing the Operator (Illuminated)

Insert a flat screwdriver into the recess of the operator and turn the screwdriver to remove the operator.

#### • Standard Position

2-Position, 90°	3-Position, 45°	4-Position, 45°	5-Position, 30°

[Example]

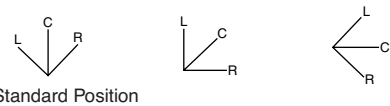

Standard Position

The non-illuminated operators can be installed in positions other than the standard position as shown above.

### Removing Contact Blocks, Transformers, and Full Voltage Adapters

Insert the end of the contact block removal tool into the snap-fit latch of the contact block (or transformer, full voltage adapter) and pull the tool as shown on the right.

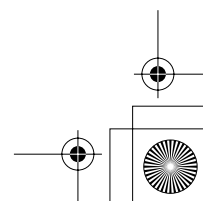
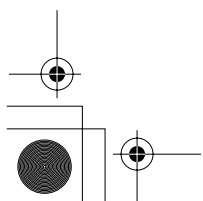
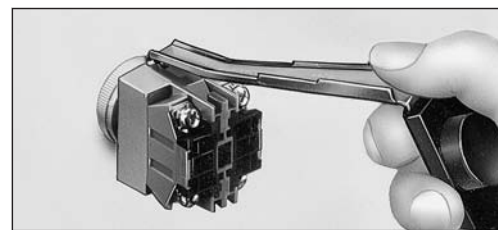

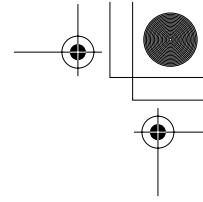
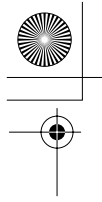

# TWS Series Instructions ø25

## Instructions

### Installing Lenses

#### • Lens Structure and Marking Plate

All square lens units are marking types. To engrave on the marking plate, remove the marking plate from the lens.

#### Square Pilot Lens

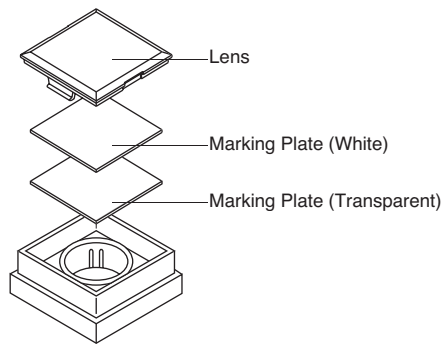

#### Square Illuminated Pushbutton

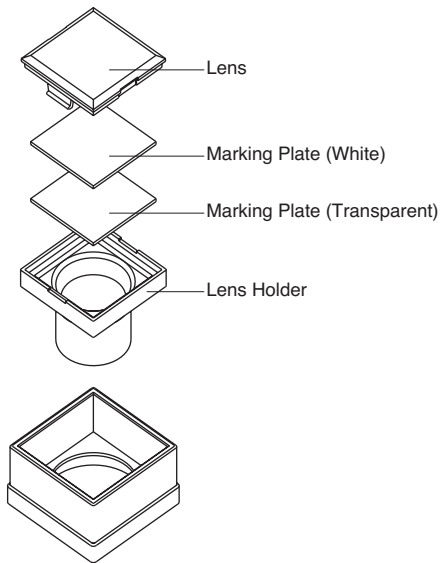

### Collective Mounting

When mounting the units closely in a horizontal row on 34mm centers, use optional barriers to prevent interconnection between adjoining terminals. The barriers can be attached simply by pressing them onto the sides of contact blocks.

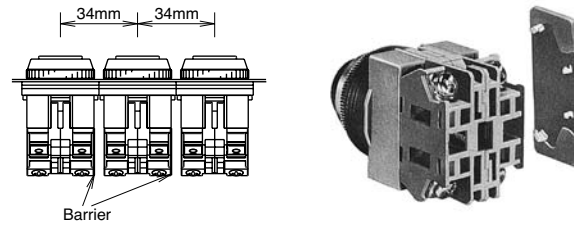

### Tightening Torque

Tighten the M3.5 terminal screws to a torque of 1.0 to 1.3 N·m.

### Replacement of Lamps

Lamps can be replaced by using the lamp holder tool (OR-55) from the front of the panel.

#### • How to remove

To remove, slip the lamp holder tool onto the lamp head lightly. Then push slightly, and turn the lamp holder tool counterclockwise.

#### • How to install

To install, insert the lamp head into the lamp holder tool. Place the pins on the lamp base to the grooves in the lamp socket. Insert the lamp and turn it clockwise.



OR-55

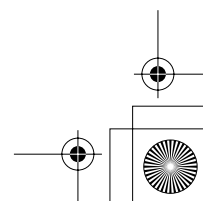
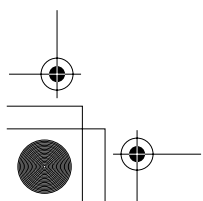

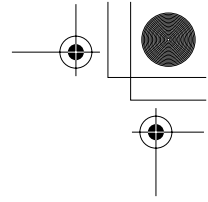
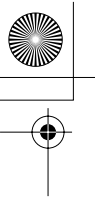

## ø25 TWS Series Instructions

### Instructions

#### Panel Thickness and Rubber Washer

Adjust the thickness of the rubber washers according to the panel thickness. Also, make sure to include the nameplate thickness when using a nameplate.

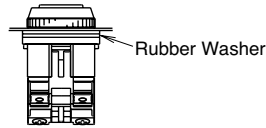

#### Applicable Models

- Momentary Type Pushbutton (Excluding Extended with Half Shroud, Extended with Full Shroud, and Square Type)
- Round Pilot Light (APS1)

Panel Thickness (mm)	Rubber Washer	
	1.5 mm	3.0 mm
Supplied	2 pieces	1 piece
0.8 to 2.5	2 pieces	1 piece
2.5 to 4.0	1 piece	1 piece
4.0 to 5.5	—	1 piece
5.5 to 6.0	1 piece	—

#### Applicable Models

- Momentary Type Pushbutton with Half Shroud (ABGS2)

Panel Thickness (mm)	Rubber Washer	
	1.5 mm	3.0 mm
Supplied	1 piece	1 piece
0.8	1 piece	1 piece
0.8 to 2.3	—	1 piece
2.3 to 3.8	1 piece	—

#### Applicable Models

- Maintained Type Extended Pushbutton with Half Shroud (AOGS2)
- Momentary Type Illuminated Pushbutton with Half Shroud (ALGS2)
- Maintained Type Illuminated Pushbutton with Half Shroud (AOLGS2)

Panel Thickness (mm)	Rubber Washer	
	1.5 mm	3.0 mm
Supplied	2 pieces	1 piece
0.8	2 pieces	1 piece
0.8 to 2.3	1 piece	1 piece
2.3 to 3.8	—	1 piece
3.8 to 5.3	1 piece	—

#### Applicable Models

- Momentary Type Extended Pushbutton with Full Shroud (ABFS2)

Panel Thickness (mm)	Rubber Washer	
	1.5 mm	3.0 mm
Supplied	3 pieces	1 piece
0.8 to 1.5	3 pieces	1 piece
1.5 to 3	2 pieces	1 piece
3.0 to 4.5	1 piece	1 piece
4.5 to 6	—	1 piece

#### Applicable Models

- Maintained Type Extended Pushbutton with Full Shroud (AOFSS2)

Panel Thickness (mm)	Rubber Washer	
	1.5 mm	3.0 mm
Supplied	4 pieces	1 piece
0.8 to 1.5	4 pieces	1 piece
1.5 to 3.0	3 pieces	1 piece
3.0 to 4.5	2 pieces	1 piece
4.5 to 6.0	1 piece	1 piece

#### Applicable Models

- Other Models (Excluding Square Types)

Panel Thickness (mm)	Rubber Washer	
	1.5 mm	3.0 mm
Supplied	3 pieces	1 piece
0.8 to 2.5	3 pieces	1 piece
2.5 to 4.0	2 pieces	1 piece
4.0 to 5.5	1 piece	1 piece
5.5 to 6.0	—	1 piece

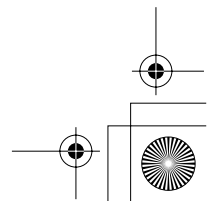
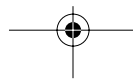
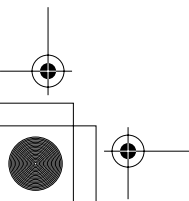
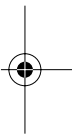
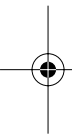

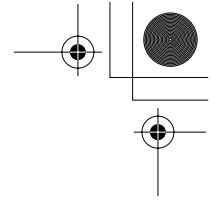
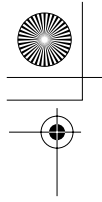

## TWS Series Instructions ø25

### Installation of LED Illuminated Units

- Note the polarity for wiring when connecting to DC-DC converter unit.

Terminal No.	Polarity
X1	Positive
X2	Negative

- Transformer type units are recommended for use in areas subjected to noise.

- Notes for Pure White LED Lamps

- Do not use the pure white LED outdoors, otherwise it will lead to the degradation of brightness and color. Do not remove or apply shock to the cap on the pure white LED lamp, otherwise it may break or damage the cap.
- For the pure white LED, use a white lens. The illumination color will be dull if a different color is used.

### Notes on LED Illuminated Units

LED lamps consist of semiconductors. If the applied voltage exceeds the rated voltage, LED elements may deteriorate due to overheat, resulting in significant decrease in luminance, hue change, or failure of lighting. Also, if an extraneous noise, transient voltage, or transient current is applied to the circuit, similar effects may occur. When using LED lamps, observe the following instructions.

#### • Rated Voltage

The LED lamps are rated at 6V, 12V, or 24V AC/DC, and can be used within  $\pm 10\%$  the rated voltage of either AC or DC.

#### • DC Power

- Switching power supply  
Regulated voltage from switching power supply is best suited. Make sure to use within the rated voltage of the LED lamp.
- Rechargeable battery  
Note that the battery voltage may exceed the rated voltage of the LED lamp while the battery is being charged and immediately after the charging is complete. Be sure to use the LED lamp on a voltage of  $\pm 10\%$  the rated voltage.
- Full-wave rectification  
Since the LED lamp is AC/DC compatible, a diode bridge for rectification is not necessary. If the LED lamp is used on a full-wave rectification current through a diode bridge, the rectifier diodes will reduce the voltage, resulting in lower luminance.
- Single-phase half-wave rectification  
This is not suitable for the power source of LED lamps. Use constant-voltage DC power.

#### • Noise

LED elements deteriorate due to extraneous noise, resulting in significant decrease in luminance, hue change, or failure of lighting. When such effects are anticipated, take a protection measure shown below, such as RC elements or a surge absorber.

#### [Protection Example 1] For AC circuit

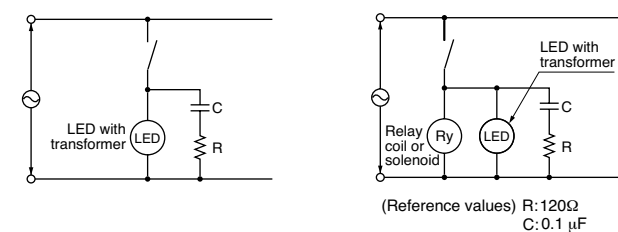

#### [Protection Example 2] For DC circuit

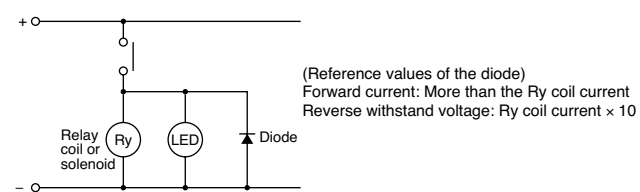

#### • Countermeasures against Dim Lighting

- Leakage currents through the transistors or a contact protection circuit may cause the LED lamp to illuminate dimly even when the output is off.
- When the LED lamp is illuminated by a transistor output, take the following measure.

#### [Circuit Example]

Connect shunt resistor R in parallel with the LED lamp.

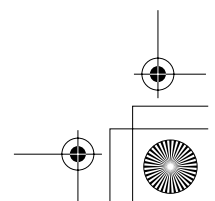
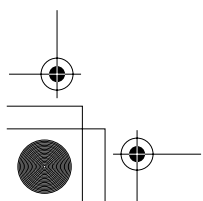
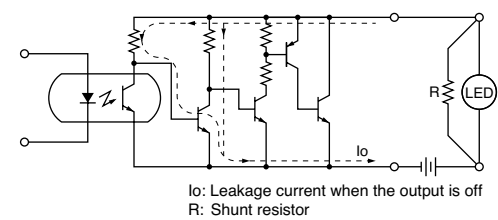

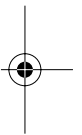
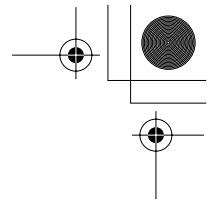
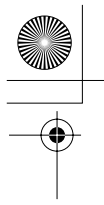

Specifications and other descriptions in this catalog are subject to change without notice.



### IDEC IZUMI CORPORATION

7-31, Nishi-Miyahara 1-Chome, Yodogawa-ku, Osaka 532-8550, Japan  
Tel: +81-6-6398-2571, Fax: +81-6-6392-9731  
www.idec.com

**IDEC CORPORATION (USA)**  
1175 Elko Drive, Sunnyvale, CA 94089-2209, USA  
Tel: +1-408-747-0550, Toll Free: (800) 262-IDEC, Fax: +1-408-744-9055  
E-mail: opencontact@idec.com, www.idec.com

**IDEC CANADA LIMITED**  
Unit 22-151, Brunel Road Mississauga, Ontario, L4Z 1X3, Canada  
Tel: +1-905-890-8561, Toll Free: (888) 317-4332, Fax: +1-905-890-8562

**IDEC ELECTRONICS LIMITED**  
Unit 2, Beechwood, Chineham Business Park, Basingstoke, Hampshire  
RG24 8WA, UK  
Tel: +44-1256-321000, Fax: +44-1256-327755  
E-mail: idec@uk.idec.com

**IDEC ELEKTROTECHNIK GmbH**  
Wendenstrasse 331, D-20537 Hamburg, Germany  
Tel: +49-40-25 30 54 10, Fax: +49-40-25 30 54 24  
E-mail: service@idec.de, www.idec.de

**IDEC AUSTRALIA PTY. LTD.**  
2/3 Macro Court, Rowville, Victoria 3178, Australia  
Toll Free: 1-800-68-4332, Fax: +61-3-9763-3255  
E-mail: sales@au.idec.com

**IDEC IZUMI ASIA PTE. LTD.**  
No. 31, Tannery Lane #05-01, Dragon Land Building, Singapore 347788  
Tel: +65-6746-1155, Fax: +65-6844-5995  
E-mail: generalinfo@idecasia.com.sg

**IDEC IZUMI (H.K.) CO., LTD.**  
Unit 1505-07, DCH Commercial Centre No. 25, Westlands Road,  
Quarry Bay, Hong Kong  
Tel: +852-2803-8989, Fax: +852-2565-0171  
E-mail: idec@idechk.com

**IDEC IZUMI (Shanghai) Co., Ltd.**  
Room E, 15F, Majesty Building, No. 138 Pudong Avenue,  
Shanghai 200120, P.R.C.  
Tel: +86-21-5887-9181, Fax: +86-21-5887-8930  
E-mail: idec@cn.idec.com

**IDEC TAIWAN CORPORATION**  
8F, No. 79, Hsin Tai Wu Road, Sec. 1, Hsi-Chih, Taipei County, Taiwan  
Tel: +886-2-2698-3929, Fax: +886-2-2698-3931  
E-mail: service@idectwn.com.tw

Cat. No. EP1089-0 JUNE 2005 13DNP PRINTED IN JAPAN

