



**Features**

- Wide input range 100~305VAC(class I )
- Full power output at 75~100% constant power mode operation
- Metal case with IP67, suitable for outdoor application
- Surge protection with 6KV/4KV
- 3 in 1 dimming (Dim-to-off and Isolation design)
- Protection Functions: OLP/SCP/OVP/OTP
- Compliance to EN60335-1 household application
- Lifetime>50,000 hours and 5 years warranty

**Applications**

- Bay lighting
- Stage lighting
- Floodlight lighting
- Horticulture lighting
- Stadium lighting
- LED strip lighting (ABV type)
- Agricultural lighting (ABV type)
- DMX power supply
- Type “HL” for use in class I , Division 2
- Household devices
- Retail and refrigerated display

**Description**

XLG-320 series is a 315W LED AC/DC driver featuring with constant power mode. XLG-320 operates from 120~305VAC and offers models with different rated current ranging between 1050mA and 7420mA. Thanks to the high efficiency up to 94.5% with the fanless design, the entire series is able to operate for -40°C~+85°C case temperature under free air convection. The design of metal housing and IP67 ingress protection level allows this series to fit both indoor and outdoor applications. Moreover the innovative environment-adaptive capability allows this series to reliably light on the LEDs for all kinds of application environments in almost any spots that may install LED luminaires in the world. XLG-320 series comply with the latest version of IEC61347/GB/19510.1 and UL8750 international safety regulations. The output and dimming circuit are also completely in accordance with the new regulations and isolation to ensure the safety of both user and luminaire system during installation.

MW Search: <https://www.meanwell.com/serviceGTIN.aspx>

**Model Encoding**

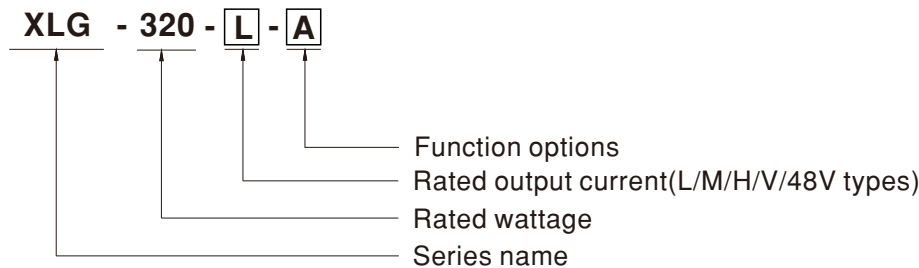

Type	IP Level	Function	Note
Blank	IP67	Io and Vo fixed.(For harsh environment)	By request
A	IP67	Output constant power adjustable via built-in Io potentiometer	In Stock
AB	IP67	Output constant power adjustable via built-in Io potentiometer + 3 in 1 dimming function (0~10Vdc, 10V PWM signal and resistance)	In Stock
ABV (48V only)	IP67	Vo adjustable via built-in potentiometer + 3 in 1 dimming function (Flicker free C.V. Dimming)	In Stock

Note: 1.V model is constant voltage operation without the AB type  
 2.48-V/48-BV types are available by modification version, please consult MEANWELL for detail.

**SPECIFICATION**

MODEL	XLG-320-L-□	XLG-320-M-□	XLG-320-H-□	XLG-320-V-□	
OUTPUT	RATED CURRENT (Default)	1400mA	2800mA	5600mA	
	RATED POWER <small>Note.11</small>	315W	310.8W	312W	
	CONSTANT CURRENT REGION	150~300V	74 ~ 148V	30 ~ 56V	
	OUTPUT VOLTAGE ADJ. RANGE	NC	NC	NC	
	FULL POWER CURRENT RANGE	1050~1400mA	2100~2800mA	5570~7420mA	
	OPEN CIRCUIT VOLTAGE (max.)	340V	180V	60V	
	CURRENT ADJ. RANGE	500~1400mA	1050~2800mA	2800~7420mA	
	CURRENT RIPPLE	5.0% max. @rated current	5.0 max. @rated current	5.0% max. @rated current	
	CURRENT TOLERANCE	±5%	±5%	±5%	
	RIPPLE & NOISE(max.)	NC	NC	NC	
	VOLTAGE TOLERANCE	NC	NC	NC	
	LINE REGULATION	NC	NC	NC	
	LOAD REGULATION	NC	NC	NC	
	SET UP TIME <small>Note.9</small>	500ms/230VAC, 1200ms/115VAC			
RISE TIME,HOLD UP TIME (Typ.)	160ms,10ms/230VAC/115VAC(only for V-type)				
INPUT	VOLTAGE RANGE <small>Note.2</small>	100 ~ 305VAC 142VDC ~ 431VDC (Please refer to "STATIC CHARACTERISTIC" ang " DRIVING METHODS OF LED MODULE"section)			
	FREQUENCY RANGE	47 ~ 63Hz			
	POWER FACTOR (Typ.)	PF ≥ 0.98 / 115VAC, PF ≥ 0.95 / 230VAC, PF ≥ 0.92 / 277VAC at full load (Please refer to "Power Factor Characteristic" section)			
	TOTAL HARMONIC DISTORTION	THD< 10% @ load ≥ 50% at 115VAC/230VAC, THD<15%@Load>75% at 277VAC; Please refer to "TOTAL HARMONIC DISTORTION (THD)" section			
	EFFICIENCY (Typ.)	94.5%	93.5%	92.5%	
	AC CURRENT (Typ.)	3A / 120VAC	1.6A / 230VAC	1.3A / 277VAC	
	INRUSH CURRENT(Typ.)	COLD START 45A(twidth=1200μs measured at 50% Ipeak) at 230VAC; Per NEMA 410			
	MAX. NO. of PSUs on 16A CIRCUIT BREAKER	2 unit(circuit breaker of type B) / 4 units(circuit breaker of type C) at 230VAC			
	LEAKAGE CURRENT	<0.75mA / 277VAC			
	STANDBY POWER CONSUMPTION <small>Note.5</small>	Standby power consumption <0.5W for AB-Type(Dimming OFF)			
	PROTECTION	SHORT CIRCUIT	Hiccup mode or Constant current limiting, recovers automatically after fault condition is removed		
OVER VOLTAGE		350 ~ 380V	190 ~ 220V	63 ~ 78V	
OVER TEMPERATURE <small>Note.12</small>		L/M/H-Type: Tcase>85°C ±5°C ,derate power automatically V-Type: Shut down output voltage, re-power on to recover			
OVER LOAD <small>Note.11</small>		108~135%(only for V-type) Hiccup mode or Constant current limiting, recovers automatically after fault condition is removed			
ENVIRONMENT	WORKING TEMP.	Tcase=-40 ~ +85°C (Please refer to "OUTPUT LOAD vs TEMPERATURE" section)			
	MAX. CASE TEMP.	Tcase=+85°C			
	WORKING HUMIDITY	20 ~ 95% RH non-condensing			
	STORAGE TEMP., HUMIDITY	-40 ~ +80°C, 10 ~ 95% RH non-condensing			
	TEMP. COEFFICIENT	±0.03%/°C (0 ~ 60°C)			
VIBRATION	10 ~ 500Hz, 5G 12min./1cycle, period for 72min. each along X, Y, Z axes				
SAFETY & EMC	SAFETY STANDARDS	UL8750(type"HL"), CSA C22.2 No. 250.13-12; ENEC BS EN/EN61347-1, BS EN/EN61347-2-13 independent, BS EN/EN62384, EN/EN60335-1 compliant to EN 60335-2-89 Annex BB, EN 60335-2-24 Annex CC;GB/T19510.1, GB/T19510.2,13;EAC TP TC 004; IP67; IS15885(Part2/Sec13)(except for blank type), KC61347-1,KC61347-2-13 approved			
	WITHSTAND VOLTAGE	I/P-O/P:3.75KVAC I/P-FG:2KVAC O/P-FG:1.5KVAC			
	ISOLATION RESISTANCE	I/P-O/P, I/P-FG, O/P-FG:100M Ohms / 500VDC / 25°C / 70% RH			
	EMC EMISSION	Parameter	Standard	Test Level / Note	
		Conducted	BS EN/EN55015(CISPR15),GB/T 17743	-----	
		Radiated	BS EN/EN55015(CISPR15),GB/T 17743	-----	
		Harmonic Current	BS EN/EN61000-3-2, GB17625.1	Class C @load≥50%	
	Voltage Flicker	BS EN/EN61000-3-3	-----		
	EMC IMMUNITY	BS EN/EN61547			
		Parameter	Standard	Test Level / Note	
ESD		BS EN/EN61000-4-2	Level 3, 8KV air ; Level 2, 4KV contact		
Radiated		BS EN/EN61000-4-3	Level 2		
EFT / Burst		BS EN/EN61000-4-4	Level 3		
Surge		BS EN/EN61000-4-5	4KV/Line-Line 6KV/Line-Earth		
Conducted		BS EN/EN61000-4-6	Level 2		
Magnetic Field		BS EN/EN61000-4-8	Level 4		
Voltage Dips and Interruptions	BS EN/EN61000-4-11	>95% dip 0.5 periods, 30% dip 25 periods, >95% interruptions 250 periods			
OTHERS	MTBF	1476.4K hrs min. Telcordia SR-332(Bellcore) ; 168.1 K hrs min. MIL-HDBK-217F (25°C)			
	DIMENSION	246*77*39.5mm (L*W*H)			
	PACKING	1.45Kg;9pcs/14Kg/0.76CUFT			
NOTE	<p>1. All parameters NOT specially mentioned are measured at 230VAC input, rated current and 25°C of ambient temperature.</p> <p>2. De-rating may be needed under low input voltages. Please refer to "STATIC CHARACTERISTIC" sections for details.</p> <p>3. The driver is considered as a component that will be operated in combination with final equipment. Since EMC performance will be affected by the complete installation, the final equipment manufacturers must re-qualify EMC Directive on the complete installation again. (as available on <a href="https://www.meanwell.com/Upload/PDF/EMI_statement_en.pdf">https://www.meanwell.com/Upload/PDF/EMI_statement_en.pdf</a>)</p> <p>4. This series meets the typical life expectancy &gt;50,000 hours of operation when Tcase, particularly (C) point (or TMP, per DLC), is 75°C or less.</p> <p>5. To fulfill requirements of the latest ErP regulation for lighting fixture, this LED driver can only be used behind a switch without permanently connected to the mains.</p> <p>6. Please refer to the warranty statement on MEAN WELL's website at <a href="http://www.meanwell.com">http://www.meanwell.com</a></p> <p>7. The ambient temperature derating of 3.5°C/1000m with fanless models and of 5°C/1000m with fan models for operating altitude higher than 2000m(6500ft).</p> <p>8. For any application note and IP water proof function installation caution, please refer our user manual before using. <a href="https://www.meanwell.com/Upload/PDF/LED_EN.pdf">https://www.meanwell.com/Upload/PDF/LED_EN.pdf</a></p> <p>9. Products sourced from the Americas regions may not have the ENEC/CCC/KC logo. Please contact your MEAN WELL sales for more information.</p> <p>10. Some products may not have the BIS logo, please contact your MEAN WELL sales for more information.</p> <p>11.The output voltage of the V Type default is 24V, for 12V output, please adjust SVR by clockwise direction to the end, otherwise the OLP point is not within the specification range.</p> <p>12. When the secondary OTP fails, there is also a primary OTP, which is protected by Shut down output voltage, re-power on to recovery for the H/M/L-type.</p> <p>13. When the current adjustment is more than 110% of the rated current, it will be enter the Protection state.</p> <p>14. V.H type:RCM is on a voluntary basis. Non IC classification Independent LED control gear is not suitable for residential installations. M.L type:RCM is on a voluntary basis and meets relevant IEC or AS/NZS standards complying with AS/NZS 4417.1.</p> <p>15. It may has an over-shoot status at output current when AC On/Off operate with lower Vf and lower loading conditions.</p> <p>16. If you need the NOM (Mexico) certificate, Please contact MEAN WELL sales representative for details.</p> <p>17. Ripple &amp; noise are measured at 20MHz of bandwidth by using a 12" twisted pair-wire terminated with a 0.1uf &amp; 47uf parallel capacitor.</p> <p>18. Please refer to "DRIVING METHODS OF LED MODULE".</p> <p>19. For A/AB/ABV type need to consider build in using to comply with Type HL application. nation, please refer to <a href="https://www.meanwell.com/serviceDisclaimer.aspx">https://www.meanwell.com/serviceDisclaimer.aspx</a></p>				



## SPECIFICATION

MODEL		XLG-320-48-ABV		
OUTPUT	RATED CURRENT	6.5A		
	RATED POWER (Max.)	312W		
	DC VOLTAGE	48V(Adjustable 43.2~52.8V)		
	RIPPLE & NOISE(max.)	250mVp-p		
	VOLTAGE TOLERANCE	±2.0%		
	LINE REGULATION	±0.5%		
	LOAD REGULATION	±0.5%		
	DIMMING TOLERANCE	±4%		
	SET UP TIME	Note.9	500ms/230VAC, 1200ms/115VAC	
RISE TIME,HOLD UP TIME (Typ.)	160ms,10ms/230VAC/115VAC			
INPUT	VOLTAGE RANGE	Note.2	100 ~ 305VAC 142VDC ~ 431VDC (Please refer to "STATIC CHARACTERISTIC" )	
	FREQUENCY RANGE	47 ~ 63Hz		
	POWER FACTOR (Typ.)	PF ≥ 0.98 / 115VAC, PF ≥ 0.95 / 230VAC, PF ≥ 0.92 / 277VAC at full load		
	TOTAL HARMONIC DISTORTION	THD< 10% @ load ≥ 50% at 115VAC/230VAC, THD<15% @ Load>75% at 277VAC;		
	EFFICIENCY (Typ.)	93.5%		
	AC CURRENT (Typ.)	3A / 120VAC 1.6A / 230VAC 1.3A / 277VAC		
	INRUSH CURRENT(Typ.)	COLD START 45A(twidth=1200μs measured at 50% Ipeak) at 230VAC; Per NEMA 410		
	MAX. NO. of PSUs on 16A CIRCUIT BREAKER	2 unit(circuit breaker of type B) / 4 units(circuit breaker of type C) at 230VAC		
	LEAKAGE CURRENT	<0.75mA / 277VAC		
	STANDBY POWER CONSUMPTION	Standby power consumption <0.5W for ABV/BV-Type(Dimming OFF)		
PROTECTION	SHORT CIRCUIT	Hiccup mode or Constant current limiting, recovers automatically after fault condition is removed		
	OVER VOLTAGE	54 ~ 60V Shut down output voltage, re-power on to recovery		
	OVER TEMPERATURE	Note.10	Shut down output voltage, re-power on to recovery 105~135%	
	OVER LOAD	Hiccup mode or Constant current limiting, recovers automatically after fault condition is removed		
ENVIRONMENT	WORKING TEMP.	Tcase=-20 ~ +85°C (Please refer to "OUTPUT LOAD vs TEMPERATURE" section)		
	MAX. CASE TEMP.	Tcase=+85°C		
	WORKING HUMIDITY	20 ~ 95% RH non-condensing		
	STORAGE TEMP., HUMIDITY	-20 ~ +80°C, 10 ~ 95% RH non-condensing		
	TEMP. COEFFICIENT	±0.03%/°C (0 ~ 60°C)		
VIBRATION	10 ~ 500Hz, 5G 12min./1cycle, period for 72min. each along X, Y, Z axes			
SAFETY & EMC	SAFETY STANDARDS	UL8750(type"HL"), CSA C22.2 No. 250.13-12; ENEC BS EN/EN61347-1, BS EN/EN61347-2-13 independent, BS EN/EN62384; IS15885(Part2 / Sec13)(Note 14), GB/T19510.1, GB/T19510.213,EAC TP TC 004; IP67 approved		
	WITHSTAND VOLTAGE	I/P-O/P:3.75KVAC I/P-FG:2KVAC O/P-FG:1.5KVAC		
	ISOLATION RESISTANCE	I/P-O/P, I/P-FG, O/P-FG:100M Ohms / 500VDC / 25°C / 70% RH		
	EMC EMISSION	Parameter	Standard	Test Level / Note
		Conducted	BS EN/EN55015(CISPR15),GB/T 17743	-----
		Radiated	BS EN/EN55015(CISPR15),GB/T 17743	-----
		Harmonic Current	BS EN/EN61000-3-2, GB17625.1	Class C @load≥50%
	Voltage Flicker	BS EN/EN61000-3-3	-----	
	EMC IMMUNITY	BS EN/EN61547		
		Parameter	Standard	Test Level / Note
ESD		BS EN/EN61000-4-2	Level 3, 8KV air ; Level 2, 4KV contact	
Radiated		BS EN/EN61000-4-3	Level 2	
EFT / Burst		BS EN/EN61000-4-4	Level 3	
Surge		BS EN/EN61000-4-5	4KV/Line-Line 6KV/Line-Earth	
Conducted		BS EN/EN61000-4-6	Level 2	
Magnetic Field	BS EN/EN61000-4-8	Level 4		
Voltage Dips and Interruptions	BS EN/EN61000-4-11	>95% dip 0.5 periods, 30% dip 25 periods, >95% interruptions 250 periods		
OTHERS	MTBF	1476.4K hrs min. Telcordia SR-332(Bellcore) ; 168.1 K hrs min. MIL-HDBK-217F (25°C)		
	DIMENSION	246*77*39.5mm (L*W*H)		
	PACKING	1.45Kg;9pcs/14Kg/0.76CUFT		
NOTE	<p>1. All parameters NOT specially mentioned are measured at 230VAC input, rated current and 25°C of ambient temperature.</p> <p>2. De-rating may be needed under low input voltages. Please refer to "STATIC CHARACTERISTIC" sections for details.</p> <p>3. The driver is considered as a component that will be operated in combination with final equipment. Since EMC performance will be affected by the complete installation, the final equipment manufacturers must re-qualify EMC Directive on the complete installation again. (as available on <a href="https://www.meanwell.com/Upload/PDF/EMI_statement_en.pdf">https://www.meanwell.com/Upload/PDF/EMI_statement_en.pdf</a>)</p> <p>4. This series meets the typical life expectancy &gt;50,000 hours of operation when Tcase, particularly Ⓢ point (or TMP, per DLC), is 75°C or less.</p> <p>5. To fulfill requirements of the latest ErP regulation for lighting fixture, this LED driver can only be used behind a switch without permanently connected to the mains.</p> <p>6. Please refer to the warranty statement on MEAN WELL's website at <a href="http://www.meanwell.com">http://www.meanwell.com</a></p> <p>7. The ambient temperature derating of 3.5°C/1000m with fanless models and of 5°C/1000m with fan models for operating altitude higher than 2000m(6500ft).</p> <p>8. For any application note and IP water proof function installation caution, please refer our user manual before using. <a href="https://www.meanwell.com/Upload/PDF/LED_EN.pdf">https://www.meanwell.com/Upload/PDF/LED_EN.pdf</a></p> <p>9. Products sourced from the Americas regions may not have the ENEC/CCC/KC logo. Please contact your MEAN WELL sales for more information.</p> <p>10. When the secondary OTP fails, there is also a primary OTP, which is protected by Shut down output voltage, re-power on to recovery.</p> <p>11. Ripple &amp; noise are measured at 20MHz of bandwidth by using a 12" twisted pair-wire terminated with a 0.1uf &amp; 47uf parallel capacitor.</p> <p>12. Please refer to "DRIVING METHODS OF LED MODULE".</p> <p>13. 48 type:RCM is on a voluntary basis. Non IC classification Independent LED control gear is not suitable for residential installations.</p> <p>14. Products sourced from the China regions may not have the BIS logo, please contact your MEAN WELL sales for more information.</p> <p>15. For A/AB/ABV type need to consider build in using to comply with Type HL application.</p> <p>※ Product Liability Disclaimer : For detailed information, please refer to <a href="https://www.meanwell.com/serviceDisclaimer.aspx">https://www.meanwell.com/serviceDisclaimer.aspx</a></p>			

**BLOCK DIAGRAM**

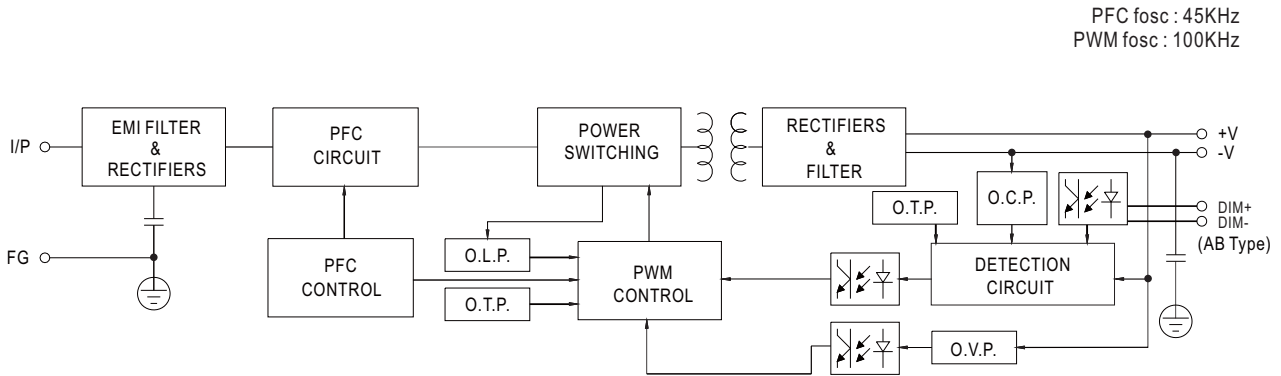

**DRIVING METHODS OF LED MODULE**

◎ **XLG-320-L**

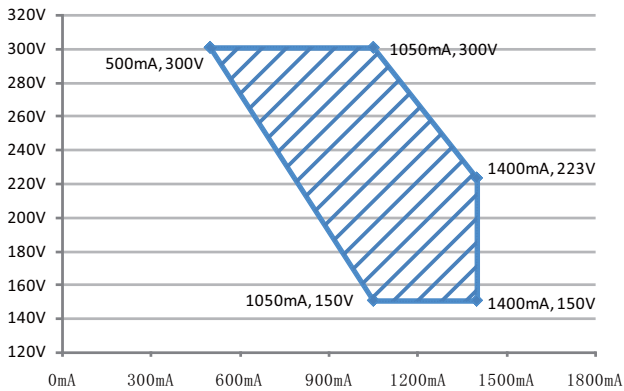

◎ **XLG-320-M**

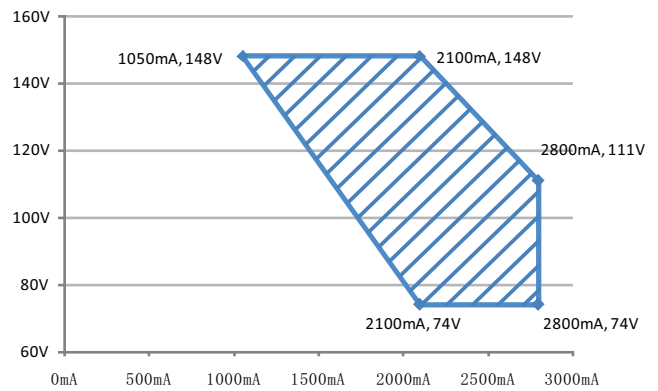

◎ **XLG-320-H**

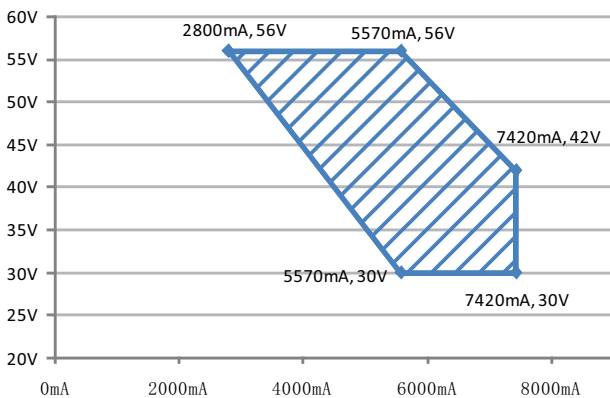

◎ **XLG-320-V**

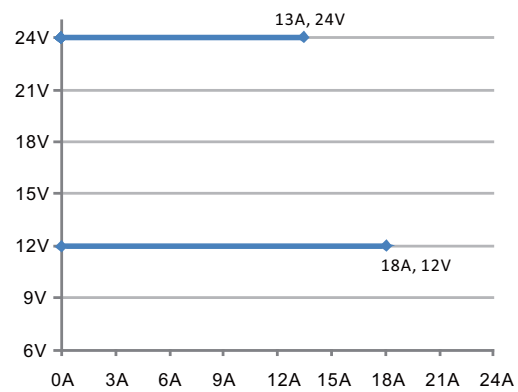

※ V type output voltage adjustable via built-in potentiometer

**■ DIMMING OPERATION**

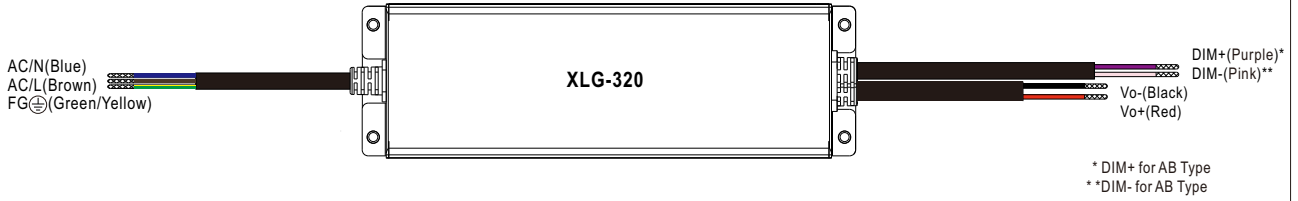

※ **3 in 1 dimming function (for AB-Type)**

- Output constant current level can be adjusted by applying one of the three methodologies between DIM+ and DIM-: 0 ~ 10VDC, or 10V PWM signal or resistance.
- Direct connecting to LEDs is suggested. It is not suitable to be used with additional drivers.
- Dimming source current from power supply: 100  $\mu$  A (typ.)

◎ Applying additive 0 ~ 10VDC

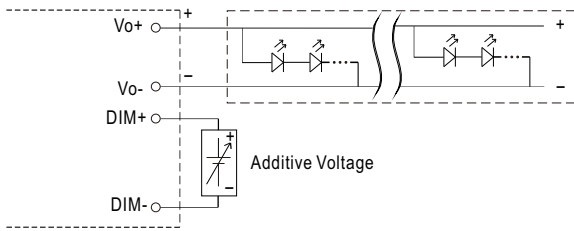

"DO NOT connect "DIM- to Vo-"

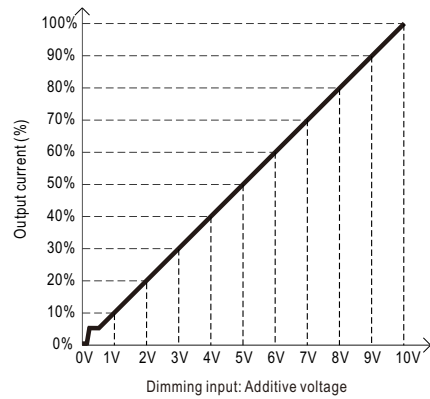

◎ Applying additive 10V PWM signal (frequency range 100Hz ~ 3KHz):

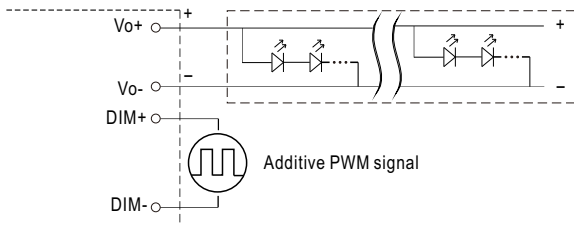

"DO NOT connect "DIM- to Vo-"

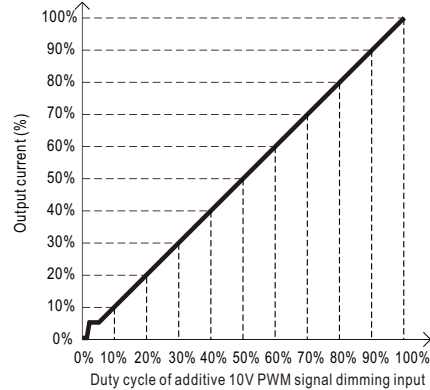

◎ Applying additive resistance:

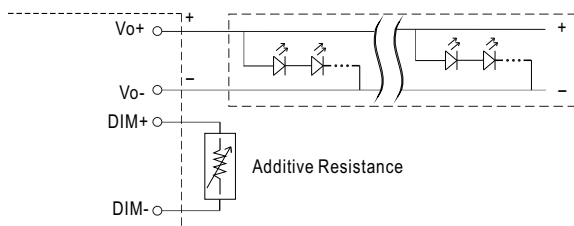

"DO NOT connect "DIM- to Vo-"

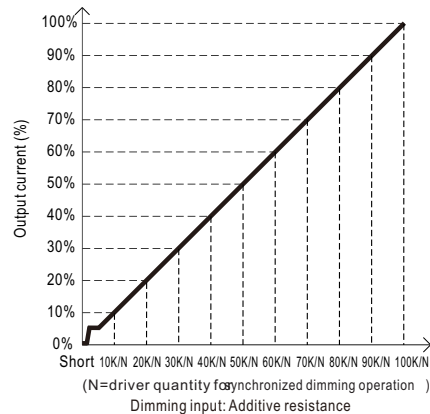

- Note :
1. Min. dimming level is about 8% and the output current is not defined when 0% < I<sub>out</sub> < 8%.
  2. The output current could drop down to 0% when dimming input is about 0 $\Omega$  or 0Vdc, or 10V PWM signal with 0% duty cycle.
  3. When PWM frequency > 2K HZ, the lighting will be triggered at 10~15% PWM duty .

**■ DIMMING OPERATION**

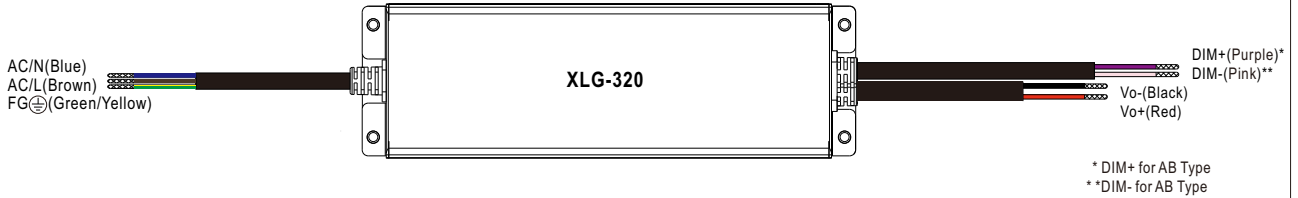

※ **3 in 1 dimming function (for ABV-Type)**

- Output constant voltage can be adjusted by applying one of the three methodologies between DIM+ and DIM-: 0 ~ 10VDC, or 10V PWM signal or resistance.
- Direct connecting to LEDs is suggested. It is not suitable to be used with additional drivers.
- Dimming source current from power supply: 100μA (typ.)
- ◎ Applying additive 0 ~ 10VDC

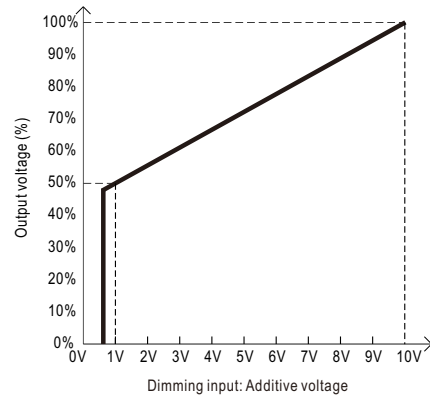
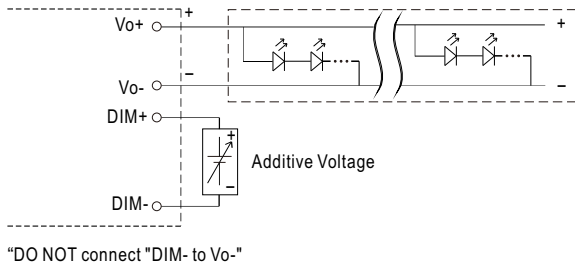

◎ Applying additive 10V PWM signal (frequency range 200Hz ~ 3KHz):

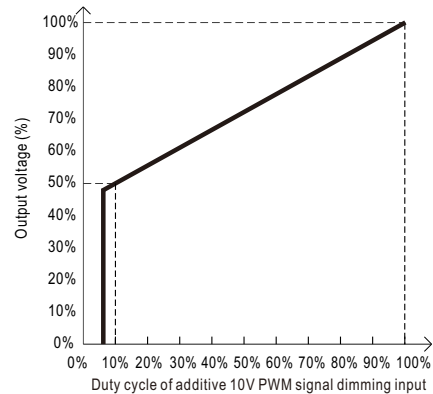
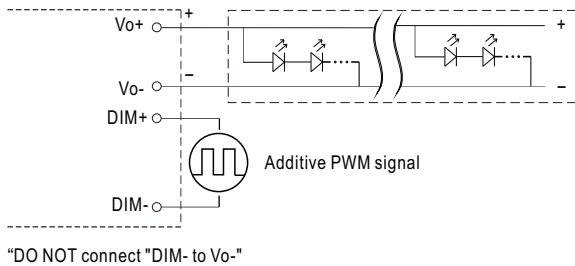

◎ Applying additive resistance:

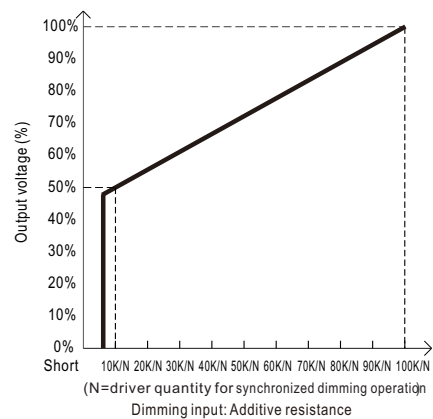
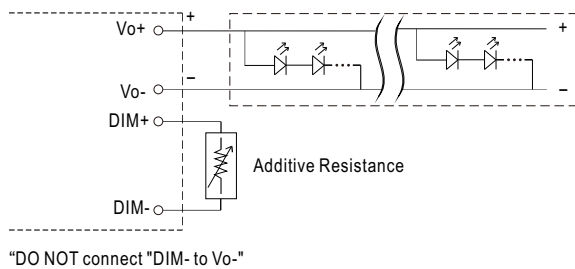

Note : 1. Min. dimming level is about 50% of output voltage and the output voltage is not defined when  $V_{out} < 50\%$   
 2. The output voltage could drop down to 0V when dimming input is about 0k or 0Vdc, or 10V PWM signal with 0% duty cycle.

**OUTPUT LOAD vs TEMPERATURE**

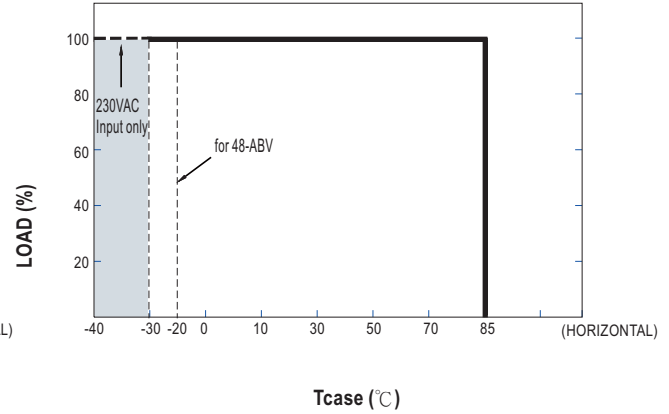
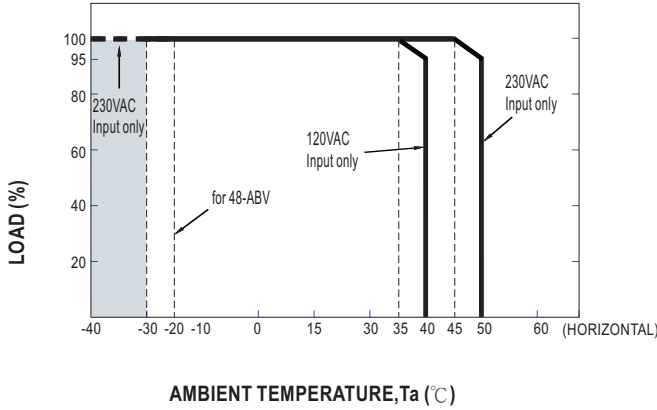

**STATIC CHARACTERISTIC**

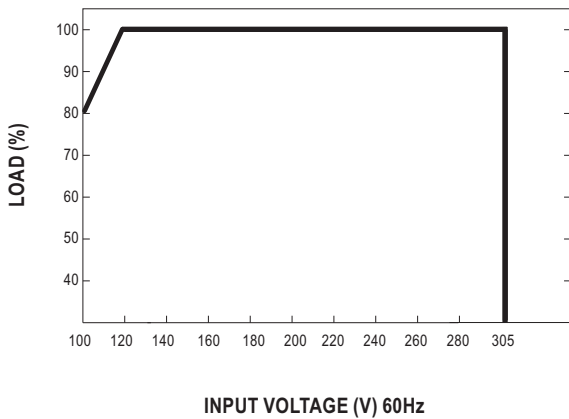

**POWER FACTOR (PF) CHARACTERISTIC**

※ Tcase at 85°C

**Constant Current Mode**

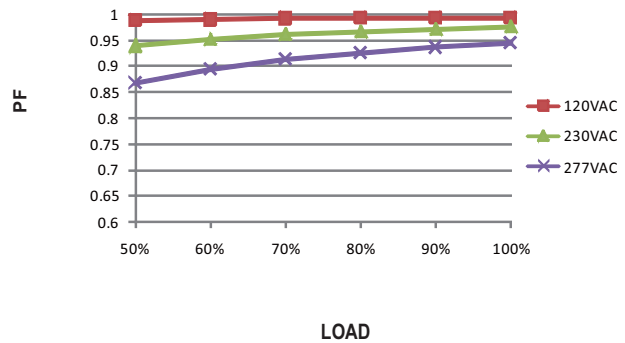

**TOTAL HARMONIC DISTORTION (THD)**

※ XLG-320-L Model, Tcase at 85°C

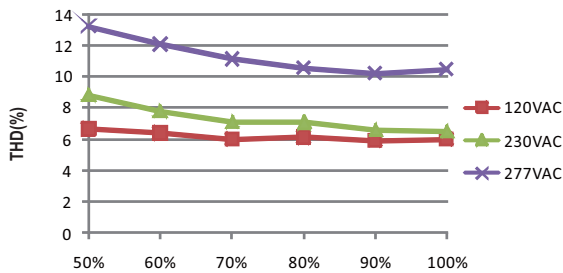

**EFFICIENCY vs LOAD**

XLG-320 series possess superior working efficiency that up to 94.5% can be reached in field applications.

※ XLG-320-L Model, Tcase at 85°C

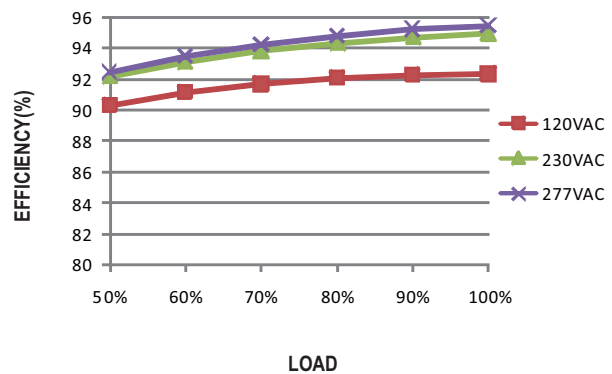

■ **CONSTANT VOLTAGE DIMMING OPERATION:**

48-ABV type

Note: flicker free design for agricultural lighting

flicker free design for Indoor LED strip lighting

Dimming Curve

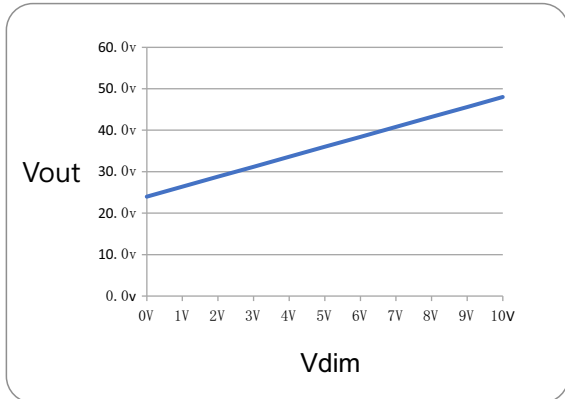

DC Voltage Level

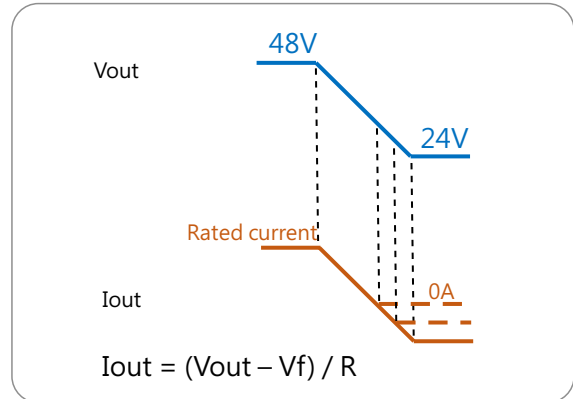

(Not a PWM style output)

■ **LIFE TIME**

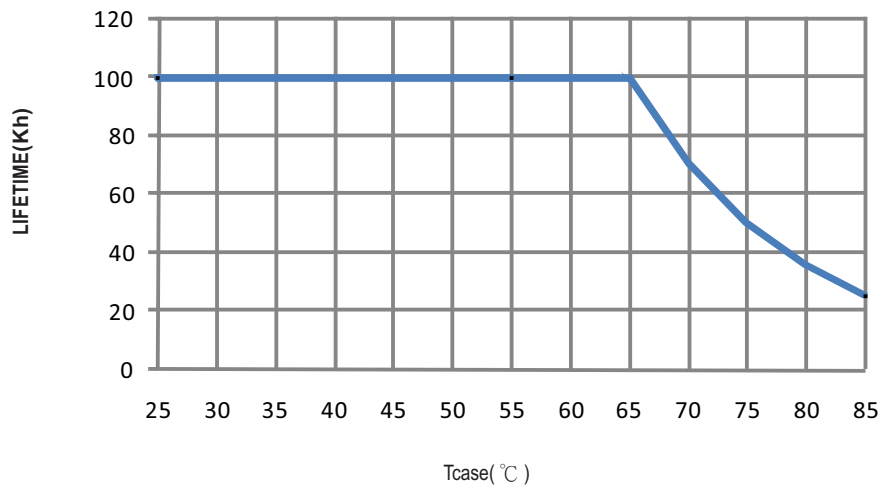

MECHANICAL SPECIFICATION

Case No.:266A Unit:mm Tolerance:±1

※ V-A-Type

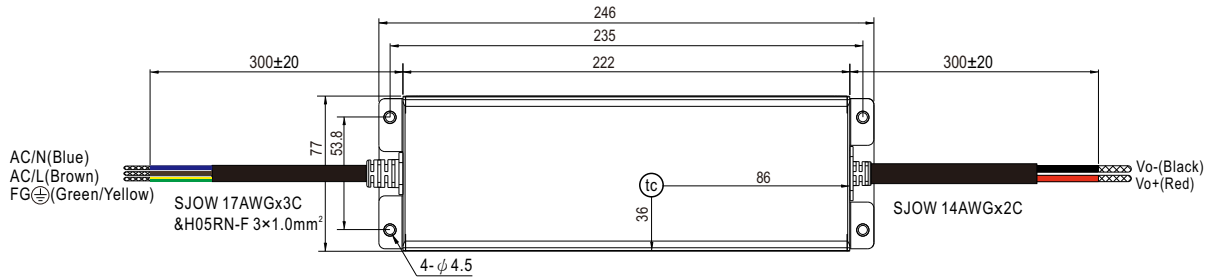

• (tc) : Max. Case Temperature

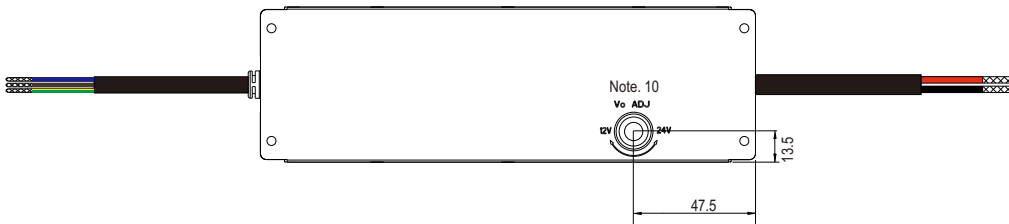

※ H/L/M-A-Type

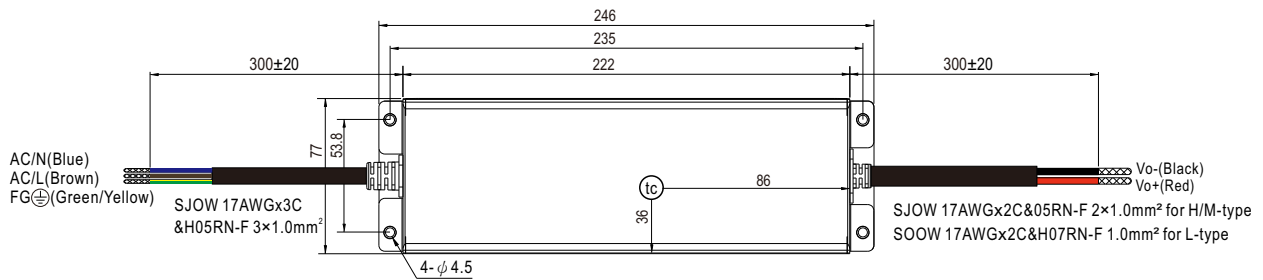

• (tc) : Max. Case Temperature

