



(Independent type)



IS 15885



NOTE.14



4883 E334687



DC Input:176-280VDC

**Features**

- Constant power mode output with multiple stage selectable by NFC setting (H-type)
- Constant voltage mode output(12V/24V)
- Plastic housing with class II and PFC design
- Meet UL 8750 Class 2 / Class P power unit
- Flicker free, complying with CE ErP directive
- Standby power consumption <0.5W
- Meet emergency lighting (EL) function application
- Fully encapsulated with IP67
- Minimum dimming level 0.1% (DALI-2 DT6)
- Dimming functions: 3 in 1 dimming (Dim-to-off) DALI-2 + Push dimming
- 5 years warranty

**Applications**

- Recessed Light
- Down Light
- Panel Light
- Commercial Lighting
- Decorative Lighting
- LED strip lighting
- DALI digital Lighting

**GTIN CODE**

MW Search: <https://www.meanwell.com/serviceGTIN.aspx>

**Description**

XLN-40 Series is a 40W with constant power and constant voltage output LED driver . It can operate from 100~305VAC and output current ranging between 600 mA to 1400 mA selectable by NFC setting. Thanks to high efficiency up to 88%, it is able to operate for -25°C ~90°C case temperature under free air convection. XLN-40 is designed based on latest safety regulation with 3 in 1 and DALI-2 dimming. XLN-40 can also be adjusted for brightness with a push button as a simple way dimming, so it provides more flexibility for LED Lighting application.

**Model Encoding**

XLN - 40 - H - □

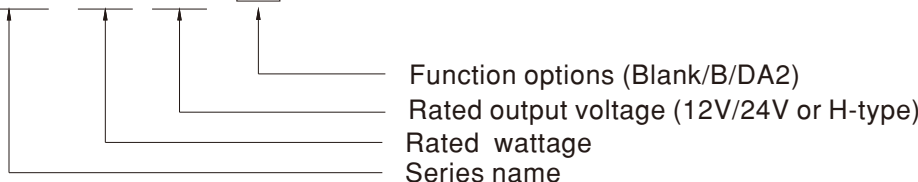

Type	Function	Note
Blank	H type output current selectable by NFC setting with constant power mode 12, 24V Constant voltage output	In stock
B	H type output current selectable by NFC setting and built in 3 in 1 dimming	
DA2	H type output current selectable by NFC setting and built in DALI-2 dimming	

Note: 1. 12V/24V output is fixed without NFC function and Dimming.  
2. For more current setting, please contact MW sales representative.

**SPECIFICATION**

MODEL		XLN-40-12	XLN-40-24	
OUTPUT	RATED VOLTAGE	12V	24V	
	RATED CURRENT	3.4A	1.7A	
	RATED POWER <small>Note.2</small>	40.8W	40.8W	
	RIPPLE & NOISE (max.) <small>Note.3</small>	120mVp-p	240mVp-p	
	VOLTAGE TOLERANCE <small>Note.4</small>	±4.0%		
	LINE REGULATION	±0.5%		
	LOAD REGULATION	±2%		
SETUP, RISE TIME <small>Note.5</small>	500ms, 100ms/230VAC, 1000ms, 100ms/115VAC			
INPUT	VOLTAGE RANGE	100 ~ 305VAC 141 ~ 400VDC		
	FREQUENCY RANGE	47 ~ 63Hz		
	POWER FACTOR	PF ≥ 0.97/115VAC, PF ≥ 0.95/230VAC, PF ≥ 0.92/277VAC@full load (Please refer to "POWER FACTOR (PF) CHARACTERISTIC" section)		
	TOTAL HARMONIC DISTORTION	THD<10%(@load ≥ 50%/230VAC; @load ≥ 75%/277VAC), THD<15%(@load ≥ 50%/115VAC) (Please refer to "TOTAL HARMONIC DISTORTION(THD)" section)		
	EFFICIENCY (Typ.)	86%	88%	
	AC CURRENT	0.5A / 115VAC 0.25A / 230VAC 0.2A/277VAC		
	INRUSH CURRENT(Typ.)	COLD START 10A(twidth=100µs measured at 50% Ipeak) at 230VAC; Per NEMA 410		
	MAX. No. of PSUs on 16A CIRCUIT BREAKER	51 units (circuit breaker of type B) / 51 units (circuit breaker of type C) at 230VAC		
LEAKAGE CURRENT	<0.75mA / 277VAC			
PROTECTION	OVER LOAD	105 ~ 220% rated output power Protection type:Hiccup mode , recovers automatically after fault condition is removed		
	SHORT CIRCUIT	Hiccup mode, recovers automatically after fault condition is removed		
	OVER VOLTAGE	13 ~ 16V	26 ~ 32V	
	OVER TEMPERATURE	Shut down output voltage, recovers automatically after fault condition is removed		
ENVIRONMENT	WORKING TEMP.	Tcase=-25 ~ 90°C (Please refer to " OUTPUT LOAD vs TEMPERATURE" section)		
	MAX. CASE TEMP.	Tcase=90°C		
	WORKING HUMIDITY	20 ~ 90% RH non-condensing		
	STORAGE TEMP., HUMIDITY	-40 ~ +80°C, 10 ~ 95% RH		
	TEMP. COEFFICIENT	±0.03%/°C (0 ~ 50°C)		
VIBRATION	10 ~ 500Hz, 2G 10min./1cycle, period for 60min. each along X, Y, Z axes			
SAFETY & EMC	SAFETY STANDARDS	ENEC BS EN/EN61347-1, BS EN/EN61347-2-13(EL) appendix J suitable for emergency installations(DC input 176-280VDC); BS EN/EN62384, BIS IS15885(Part2/Sec13)(NOTE 14), GB/T19510.1, GB/T19510.2,13, EAC TP TC 004,UL8750(Type HL and Class P); CSA C22.2 No. 250.13-12 approved;Design refer to AS/NZS 61347-1, AS/NZS 61347-2-13;		
	WITHSTAND VOLTAGE	I/P-O/P:3.75KVAC		
	ISOLATION RESISTANCE	I/P-O/P:>100M Ohms / 500VDC / 25°C / 70% RH		
	EMC EMISSION	Parameter	Standard	Test Level/Note
		Conducted	BS EN/EN55015(CISPR15) ,GB/T 17743	-----
		Radiated	BS EN/EN55015(CISPR15) ,GB/T 17743	-----
		Harmonic Current	BS EN/EN61000-3-2 , GB17625.1	Class C @load≥50%
	Voltage Flicker	BS EN/EN61000-3-3	-----	
	EMC IMMUNITY	Parameter	Standard	Test Level/Note
		ESD	BS EN/EN61000-4-2	Level 3, 8KV air ; Level 2, 4KV contact
Radiated		BS EN/EN61000-4-3	Level 2	
EFT/Burst		BS EN/EN61000-4-4	Level 2	
Surge		BS EN/EN61000-4-5	Level 3, 1KV/Line-Line	
Conducted		BS EN/EN61000-4-6	Level 2	
Magnetic Field		BS EN/EN61000-4-8	Level 2	
Voltage Dips and Interruptions		BS EN/EN61000-4-11	70% residual voltage for 10 period, 0% residual voltage for 0.5 periods	
FLICKER <small>Note.6</small>	PstLM ≤ 1, SVM ≤ 0.4			
MTBF	3935.2 K hrs min. Telcordia SR-332 (Belcore) ; 342.9 Khrs min. MIL-HDBK-217F (25°C)			
DIMENSION	114*44*32mm (L*W*H)			
PACKING	308g; 40pcs/13.32Kg/0.95CUFT			
NOTE	<p>1. All parameters NOT specially mentioned are measured at 230VAC input, rated current and 25°C of ambient temperature.  2. De-rating may be need under low input voltages. Please refer to "STATIC CHARACTERISTIC" sections for details.  3. Ripple &amp; noise are measured at 20MHz of bandwidth by using a 12" twisted pair-wire terminated with a 0.1µF &amp; 47µF parallel capacitor.  4. Tolerance: includes set up tolerance, line regulation and load regulation.  5. Length of set up time is measured at first cold start. Turning ON/OFF the driver may lead to increase of the set up time.  6. Flicker is measured at full load with the light source provided by MEAN WELL.  7. To fulfill requirement of the latest ErP regulation for lighting fixtures, this LED driver can only be used behind a switch without permanently connected to the mains.  8. The driver is considered as a component that will be operated in combination with final equipment. Since EMC performance will be affected by the complete installation, the final equipment manufacturers must re-qualify EMC Directive on the complete installation again.  (as available on <a href="https://www.meanwell.com/Upload/PDF/EMI_statement_en.pdf">https://www.meanwell.com/Upload/PDF/EMI_statement_en.pdf</a>)  9. The ambient temperature de-rating of 3.5°C/1000m with fanless models and 5°C/1000m with fan models for operating altitude higher than 2000m(6500ft).  10. This series meets the typical life expectancy of &gt;50,000 hours of operation when Tcase, particularly (C) point (or TMP, per DLC), is about 75°C or less.  11. RCM is on a voluntary basis. Non IC classification Independent LED control gear is not suitable for residential installations.  12. Products sourced from the Americas regions may not have the CCC/PSE/BIS/KC logo. Please contact your MEAN WELL sales for more information.  13. For more information, please contact with MEAN WELL sales.  14. Products sourced from the China regions may not have the BIS logo, please contact your MEAN WELL sales for more information.  *Product Liability Disclaimer: For detailed information, please refer to <a href="https://www.meanwell.com/serviceDisclaimer.aspx">https://www.meanwell.com/serviceDisclaimer.aspx</a></p>			

**SPECIFICATION**

<b>MODEL</b>		XLN-40-H- <input type="checkbox"/>		
<b>OUTPUT</b>	<b>OPEN CIRCUIT VOLTAGE</b> <span style="float:right">Note.2</span>	60V		
	<b>DEFAULT CURRENT</b>	1050mA		
	<b>CURRENT ADJ. RANGE (BY NFC)</b>	0.6~1.4A		
	<b>CONSTANT CURRENT REGION</b> <span style="float:right">Note.3</span>	9~54V		
	<b>RATED POWER</b> <span style="float:right">Note.4</span>	40W		
	<b>CURRENT RIPPLE</b>	<4%(@full load)		
	<b>CURRENT TOLERANCE</b>	±5%		
	<b>DIMMING RANGE</b>	0~100%		
	<b>SETUP, RISE TIME</b> <span style="float:right">Note.5,6</span>	500ms, 100ms/230VAC, 1000ms, 100ms/115VAC		
<b>INPUT</b>	<b>VOLTAGE RANGE</b>	100 ~ 305VAC    141 ~ 400VDC		
	<b>FREQUENCY RANGE</b>	47 ~ 63Hz		
	<b>POWER FACTOR</b>	PF ≥ 0.97/115VAC, PF ≥ 0.95/230VAC, PF ≥ 0.92/277VAC@full load (Please refer to "POWER FACTOR (PF) CHARACTERISTIC" section)		
	<b>TOTAL HARMONIC DISTORTION</b>	THD<10%(@load ≥ 50%/230VAC; @load ≥ 75%/277VAC), THD<15%(@load ≥ 50%/115VAC) (Please refer to "TOTAL HARMONIC DISTORTION(THD)" section)		
	<b>EFFICIENCY (Typ.)</b> <span style="float:right">Note.7</span>	88%		
	<b>AC CURRENT</b>	0.5A/ 115VAC    0.25A/ 230VAC    0.2A/277VAC		
	<b>INRUSH CURRENT(Typ.)</b>	COLD START 10A(twidth=100µs measured at 50% Ipeak) at 230VAC; Per NEMA 410		
	<b>MAX. No. of PSUs on 16A CIRCUIT BREAKER</b>	51 units (circuit breaker of type B) / 51 units (circuit breaker of type C) at 230VAC		
	<b>LEAKAGE CURRENT</b>	<0.75mA/ 277VAC		
	<b>STANDBY POWER CONSUMPTION</b> <span style="float:right">Note.8</span>	Standby power consumption<0.5W(Dimming off)		
<b>PROTECTION</b>	<b>SHORT CIRCUIT</b>	Hiccup mode, recovers automatically after fault condition is removed		
	<b>OVER TEMPERATURE</b>	Blank & B type: De-rating to lowest output level. Recovers automatically after fault condition is removed. DA2 type: Stage 1: De-rating to 75% loading; Stage 2: De-rating to 50% loading. Recovers automatically after fault condition is removed.		
<b>ENVIRONMENT</b>	<b>WORKING TEMP.</b>	Tcase=-25 ~ 90°C (Please refer to " OUTPUT LOAD vs TEMPERATURE" section)		
	<b>MAX. CASE TEMP.</b>	Tcase=90°C		
	<b>WORKING HUMIDITY</b>	20 ~ 90% RH non-condensing		
	<b>STORAGE TEMP., HUMIDITY</b>	-40 ~ +80°C, 10 ~ 95% RH		
	<b>TEMP. COEFFICIENT</b>	±0.03%/°C (0 ~ 50°C)		
	<b>VIBRATION</b>	10 ~ 500Hz, 2G 10min./1cycle, period for 60min. each along X, Y, Z axes		
<b>SAFETY &amp; EMC</b>	<b>SAFETY STANDARDS</b>	ENEC BS EN/EN61347-1, BS EN/EN61347-2-13(EL) appendix J suitable for emergency installations(DC input 176-280VDC); BS EN/EN62384, BIS IS15885(Part2/Sec13)(NOTE 14), GB/T19510.1, GB/T19510.2, EAC TP TC 004,UL8750(Type HL and Class P); CSA C22.2 No. 250.13-12 approved; Design refer to AS/NZS 61347-1, AS/NZS 61347-2-13 ;		
	<b>DALI STANDARDS</b>	Comply with IEC62386-101,102,207		
	<b>WITHSTAND VOLTAGE</b>	I/P-O/P:3.75KVAC		
	<b>ISOLATION RESISTANCE</b>	I/P-O/P:>100M Ohms / 500VDC / 25°C / 70% RH		
	<b>EMC EMISSION</b>	<b>Parameter</b>	<b>Standard</b>	<b>Test Level/Note</b>
		Conducted	BS EN/EN55015(CISPR15) ,GB/T 17743	-----
		Radiated	BS EN/EN55015(CISPR15) ,GB/T 17743	-----
		Harmonic Current	BS EN/EN61000-3-2 , GB17625.1	Class C @load≥50%
		Voltage Flicker	BS EN/EN61000-3-3	-----
	<b>EMC IMMUNITY</b>	BS EN/EN61547		
		<b>Parameter</b>	<b>Standard</b>	<b>Test Level/Note</b>
		ESD	BS EN/EN61000-4-2	Level 3, 8KV air ; Level 2, 4KV contact
		Radiated	BS EN/EN61000-4-3	Level 2
		EFT/Burst	BS EN/EN61000-4-4	Level 2
Surge		BS EN/EN61000-4-5	Level 3, 1KV/Line-Line	
Conducted		BS EN/EN61000-4-6	Level 2	
Magnetic Field		BS EN/EN61000-4-8	Level 2	
Voltage Dips and Interruptions	BS EN/EN61000-4-11	70% residual voltage for 10 period, 0% residual voltage for 0.5 periods		
<b>OTHERS</b>	<b>FLICKER</b> <span style="float:right">Note.9</span>	PstLM ≤ 1, SVM ≤ 0.4		
	<b>MTBF</b>	3935.2 K hrs min. Telcordia SR-332 (Bellcore) ;    342.9 Khrs min.    MIL-HDBK-217F (25°C)		
	<b>DIMENSION</b>	114*44*32mm (L*W*H)		
	<b>PACKING</b>	311g; 40pcs/13.44Kg/0.95CUFT		
<b>NOTE</b>	<p>1. All parameters NOT specially mentioned are measured at 230VAC input, rated current and 25°C of ambient temperature.</p> <p>2. Output hiccups under no-load condition.</p> <p>3. Please refer to "DRIVER METHODS OF LED MODULE".</p> <p>4. De-rating may be need under low input voltages. Please refer to "STATIC CHARACTERISTIC" sections for details.</p> <p>5. Length of set up time is measured at first cold start. Turning ON/OFF the driver may lead to increase of the set up time.</p> <p>6. Based on IEC 62386-101/102 DALI power on timing and interruption regulations, the set up time needs to test with a DALI controller which can support for DALI power on function, otherwise the startup time will be higher than 0.5 second.</p> <p>7. Efficiency is measured at 800mA/50V by NFC.</p> <p>8. Standby power consumption is measured at 230VAC.</p> <p>9. Flicker is measured at full load with the light source provided by MEAN WELL.</p> <p>10. The driver is considered as a component that will be operated in combination with final equipment. Since EMC performance will be affected by the complete installation, the final equipment manufacturers must re-qualify EMC Directive on the complete installation again. (as available on <a href="https://www.meanwell.com/Upload/PDF/EMI_statement_en.pdf">https://www.meanwell.com/Upload/PDF/EMI_statement_en.pdf</a>)</p> <p>11. RCM is on a voluntary basis. Non IC classification Independent LED control gear is not suitable for residential installations.</p> <p>12. This series meets the typical life expectancy of &gt;50,000 hours of operation when Tcase, particularly (C) point (or TMP, per DLC), is about 75°C or less.</p> <p>13. The ambient temperature de-rating of 3.5°C/1000m with fanless models and 5°C/1000m with fan models for operating altitude higher than 2000m(6500ft).</p> <p>14. Products sourced from the China regions may not have the BIS logo, please contact your MEAN WELL sales for more information.</p> <p>15. To fulfill requirements of the latest ErP regulation for lighting fixture, this LED driver can only be used behind a switch without permanently connected to the mains.</p> <p>16. Products sourced from the Americas regions may not have the CCC/PSE/BIS/KC logo. Please contact your MEAN WELL sales for more information.</p> <p>17. For more information, please contact with MEAN WELL sales.</p> <p>※Product Liability Disclaimer: For detailed information, please refer to <a href="https://www.meanwell.com/serviceDisclaimer.aspx">https://www.meanwell.com/serviceDisclaimer.aspx</a></p>			

**BLOCK DIAGRAM**

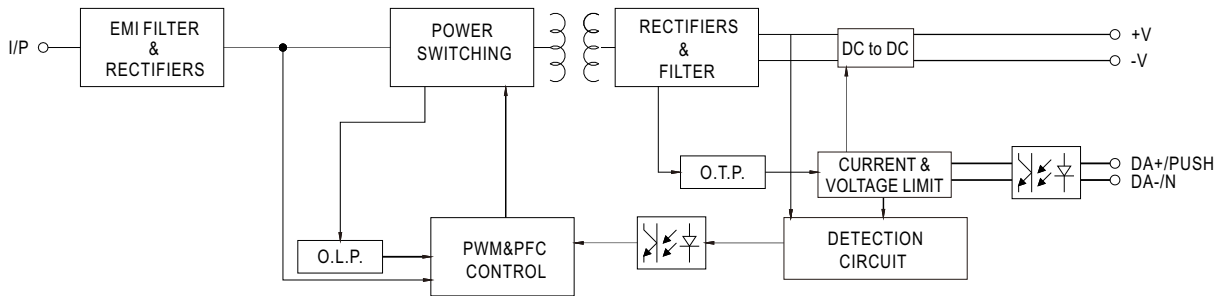

**DRIVING METHODS OF LED MODULE**

※ I-V Operating Area

◎ XLN-40-H

For 40W application

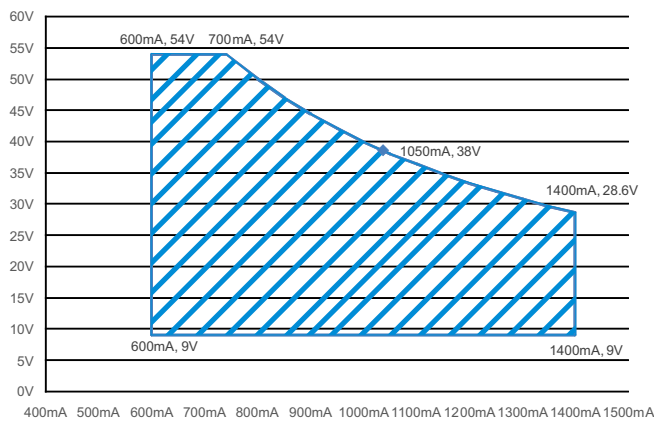

**CONSTANT POWER TABLE**

XLN-40-H is a multiple-stage constant power driver, selection of output current through NFC setting is exhibited below.

Vo	Io
9~54V	600mA
9~54V	700mA
9~50V	800mA
9~45V	900mA
9~38V	1050mA(default)
9~33V	1200mA
9~31V	1300mA
9~29V	1400mA

Note: 1. The operating voltage range which show on this table is recommend to use.

**NFC Function Description**

1. The output current of the NFC Mode LED driver can be adjusted using NFC via the mobile APP.

Operation Instruction:

● Compatible phone

Install an NFC-compatible smart mobile device or phone with AndroidTM 4.1 or IOS12 updates.

● Steps for setting output current via NFC

1. Download Meanwell APP on mobile device or mobile phone, and enable NFC function.

2. Check the NFC antenna position of the mobile phone please.

3. Enter Meanwell APP -> Top left menu -Installation Manual/APP->PowerNFC, approach the LED driver NFC sensing position and perform sensing.

4. APP displays the functional parameters, and the relevant parameters are modified as required.

5. Tap the APP write button and quickly move the phone antenna close to the NFC sensing position of the LED driver.

6. The write completes when the mobile phone displays "Success".

APP Function Description

※ APP Interface:

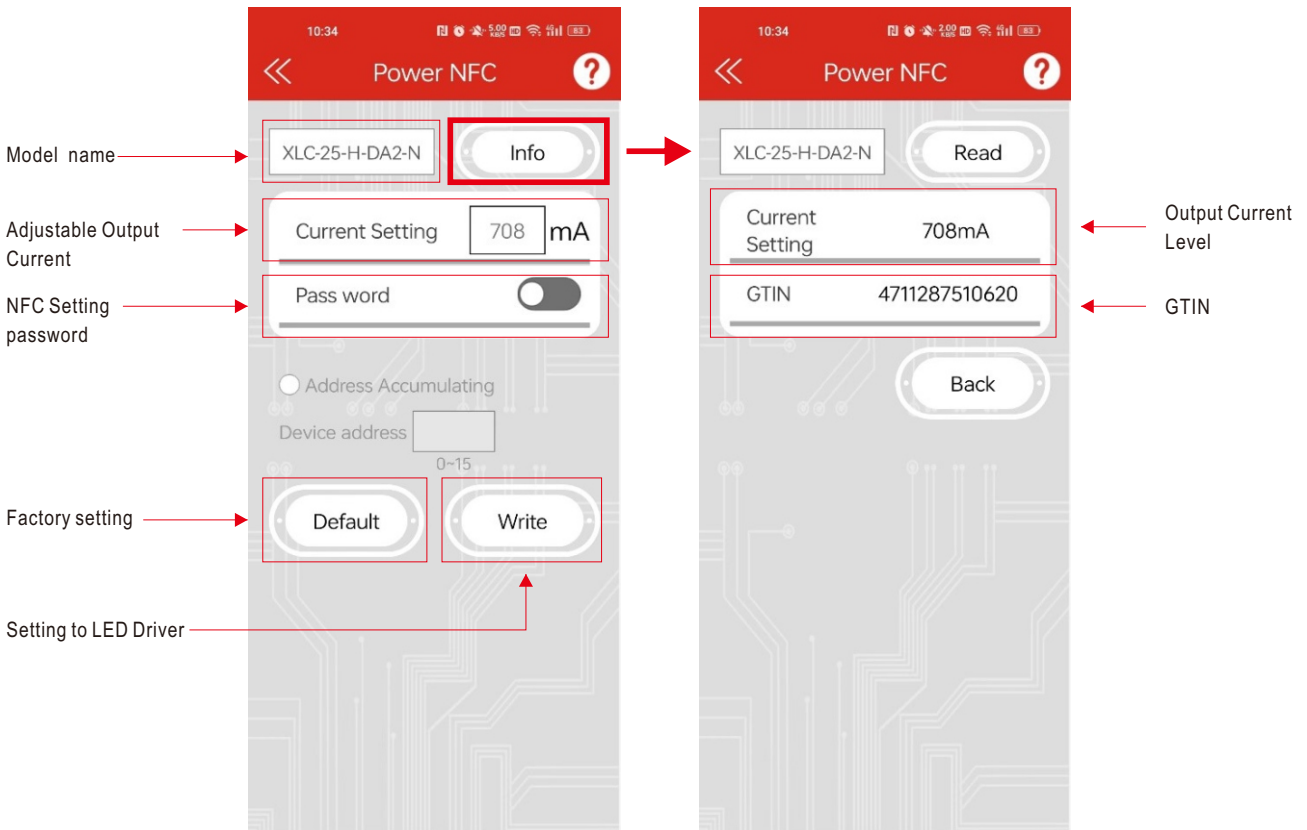

• To be used through APP available on Apple Store and Google Play Store for iOS and Android.  
Search: MEAN WELL on



Note: 1. Current accuracy : the numerical error between the set current and the actual current is within 2%.  
2. Please turn off the input power supply to the LED driver when using NFC function.

**■ DIMMING OPERATION**

◎ **B type**

※ **3 in 1 dimming function**

- Output constant current level can be adjusted by applying one of the three methodologies between DIM+ and DIM-: 0 ~ 10VDC, or 10V PWM signal or resistance.
- Direct connecting to LEDs is suggested. It is not suitable to be used with additional drivers.
- Dimming source current from power supply: 100  $\mu$ A (typ.)

◎ Applying additive 0 ~ 10VDC

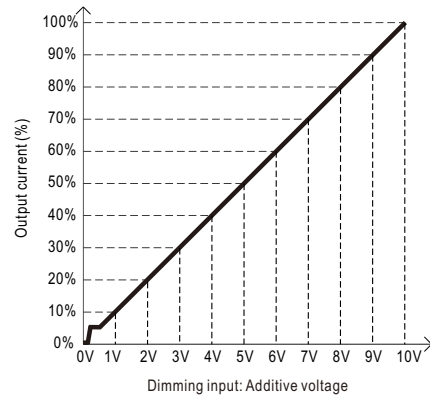
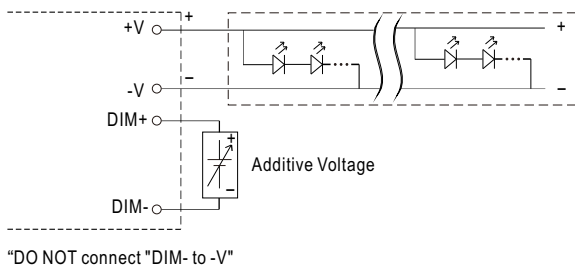

◎ Applying additive 10V PWM signal (frequency range 300Hz~3KHz):

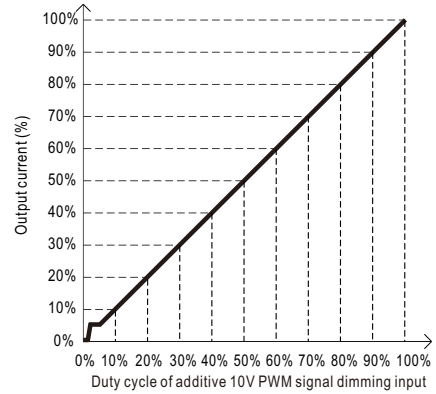
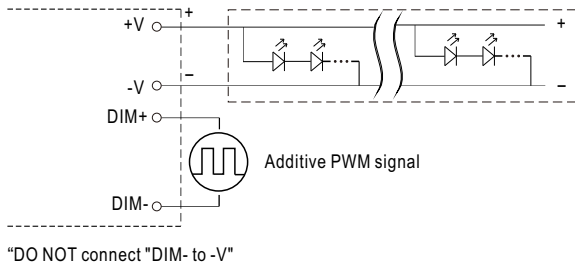

◎ Applying additive resistance: 0~100k  $\Omega$

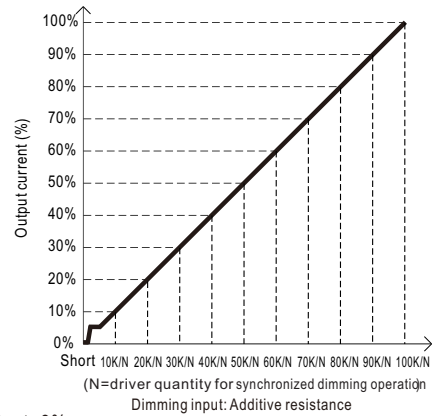
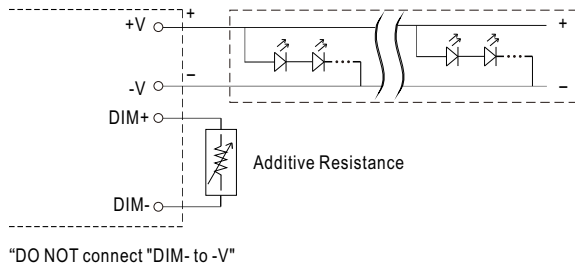

Note : 1. Min. dimming level is about 8% and the output current is not defined when 0% < I<sub>out</sub> < 8%.  
 2. The output current could drop down to 0% when dimming input is about 0k $\Omega$  or 0Vdc, or 10V PWM signal with 0% duty cycle.

**■ DIMMING OPERATION**

◎ DA2 type (DALI-2 digital dimming function)

※ Input wiring diagram

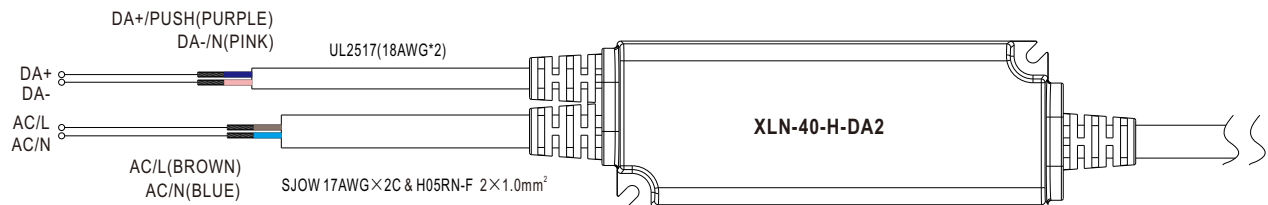
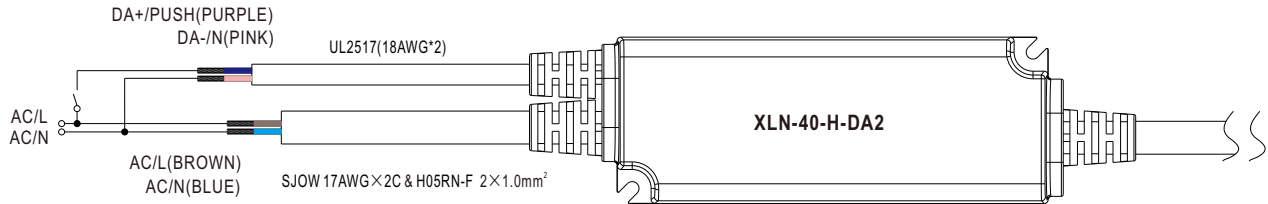

※ PUSH dimming (primary side)

- The factory default dimming level is at 100%.
- If the push action lasts less than 0.05 sec., it will not lead to a change for the status of the driver.
- Up to 10 drivers can perform the PUSH dimming at the same time when utilizing one common push button.
- The maximum length of the cable from the push button to the last driver is 20 meters.

Action	Action duration	Function
Short Push	0.1~1s	Turn ON-OFF the driver
Double Click	Click twice in 1.5s	Set up the dimming level to 100%
Long Push	1.5~10s	Every Long Push changes the dimming direction, dimming up or down

■ **OUTPUT LOAD vs TEMPERATURE**

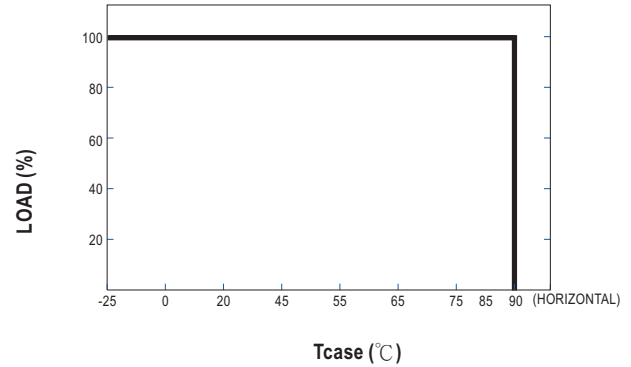
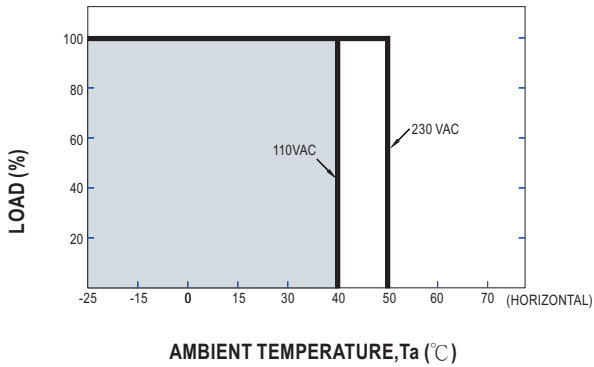

■ **STATIC CHARACTERISTIC**

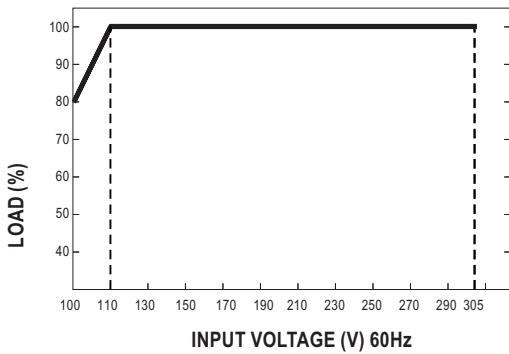

※ De-rating is needed under low input voltage.

■ **LIFE TIME**

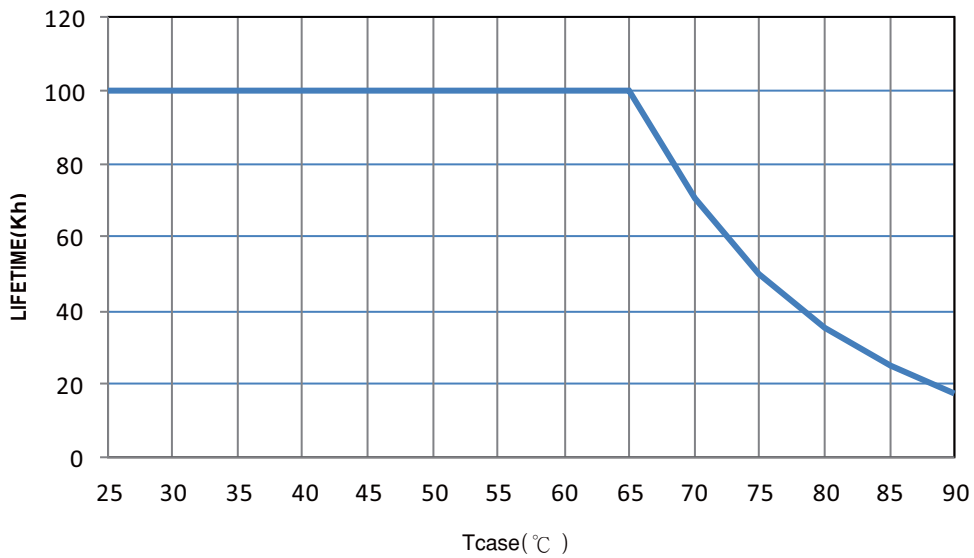

**TOTAL HARMONIC DISTORTION (THD)**

※ XLN-40-H Model, Tcase at 75°C

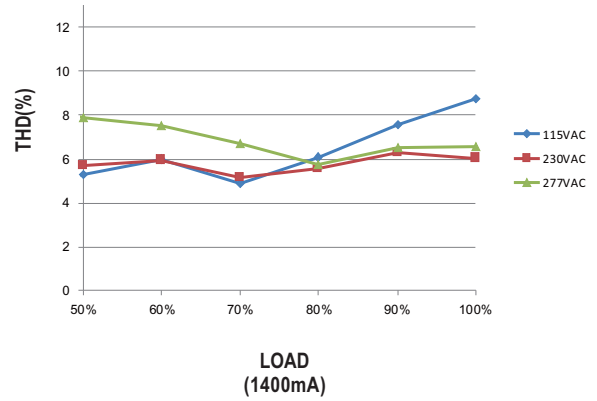
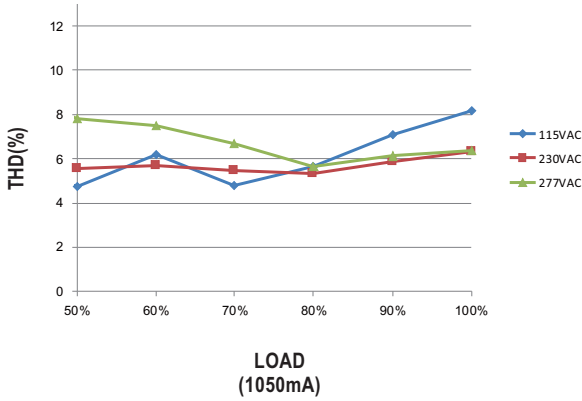

**POWER FACTOR (PF) CHARACTERISTIC**

※ XLN-40-H Model, Tcase at 75°C

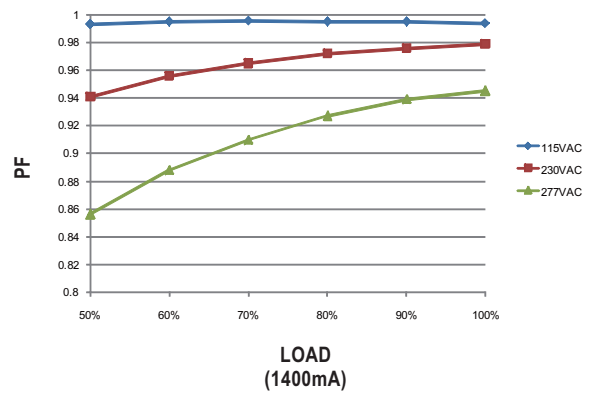
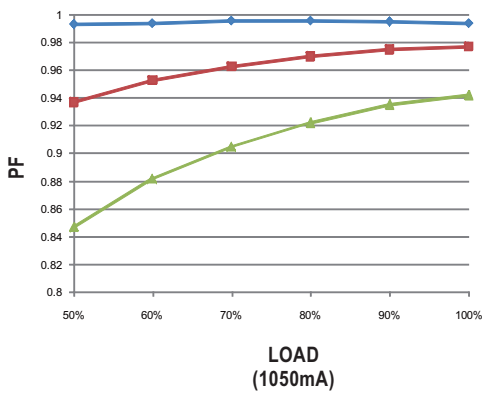

**EFFICIENCY vs LOAD**

XLN-40 series possess superior working efficiency that up to 88% can be reached in field applications.

※ XLN-40-H Model, Tcase at 75°C

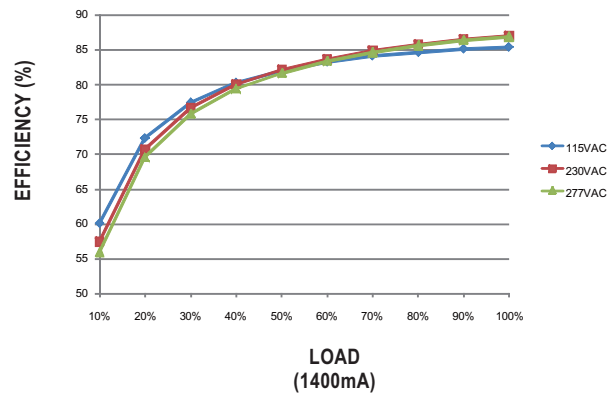
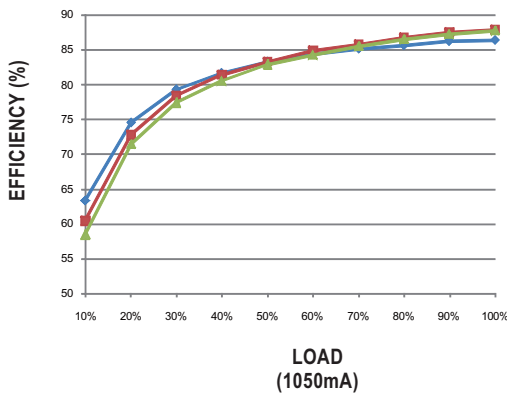

**MECHANICAL SPECIFICATION**

Case No. XLN-25 Unit: mm Tolerance: ±1

※ Blank type

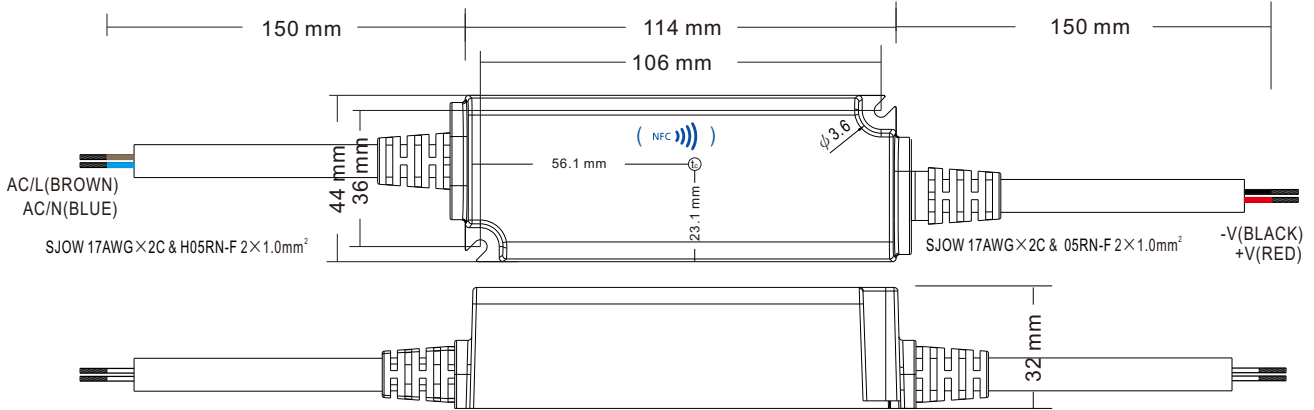

※ B type

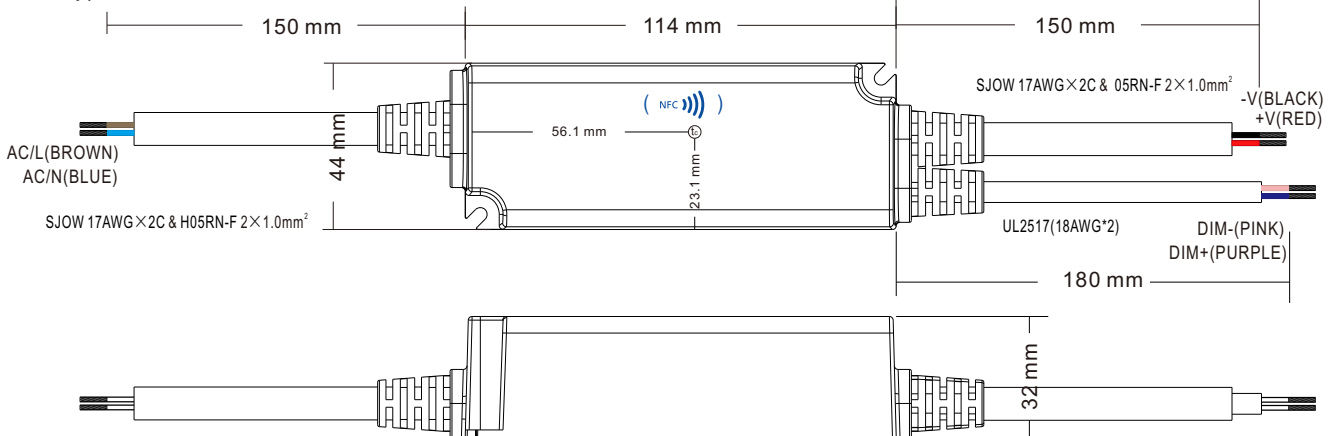

※ DA2 type

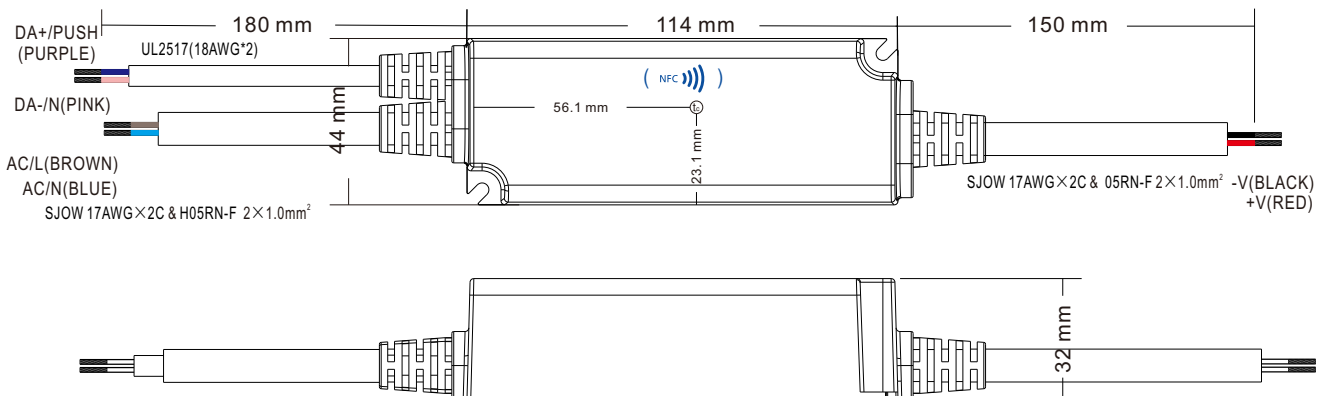

**Installation Manual**

Please refer to : <http://www.meanwell.com/manual.html>