

Data Sheet | Item Number: 232-663

Strain relief housing; for female and male connectors; 2 parts; Pin spacing 7.5 mm;
3-pole; gray

<https://www.wago.com/232-663>

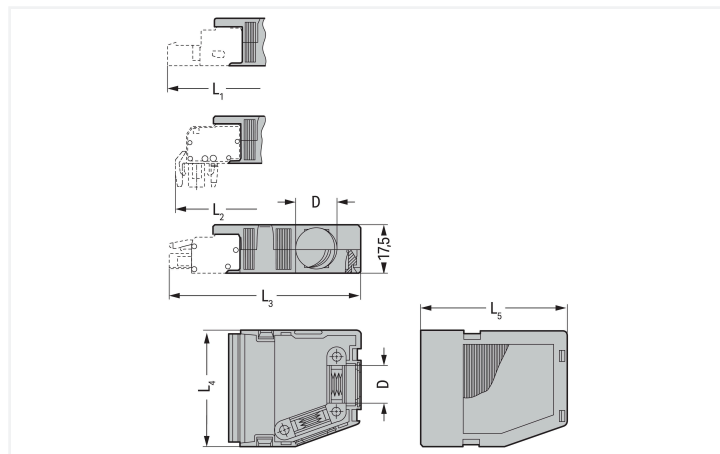
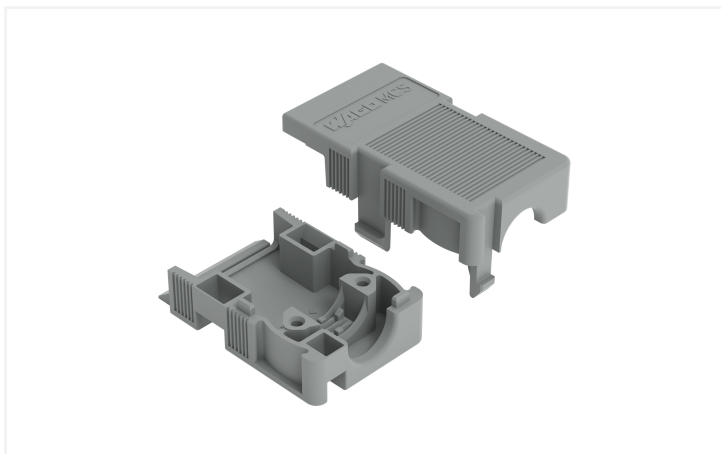

Color: ■ gray

Similar to illustration

Dimensions in mm

2-pole; only suitable for cable ties; 1 cable outlet (rear side), max. cable tie width 3.6 mm; 3- to 4-pole; suitable for cable clamp; 1 x cable outlet (rear side); 5-pole; suitable for cable clamp; 1 x cable outlet (rear side) and 1 x cable outlets (side); 1 cover (included) 7-pole; suitable for cable clamp; 1 x cable outlet (rear side) and 2 x cable outlets (side); 2 covers (included) Cable ties and binding tools are not offered by WAGO.

- Suitable for cable clamp
- 1 x cable outlet, rear

Connection Data

Connection 1

Pole number	3
-------------	---

Physical data

Pin spacing	7.5 mm / 0.295 inches
Width	23 mm / 0.906 inches
Height	17.5 mm / 0.689 inches
Depth	23 mm / 0.906 inches

Mechanical data

Suitable	for standard male and female connectors
----------	---

Material data

Note (material data)	Information on material specifications can be found here
Color	gray
Material group	I
Insulation material (main housing)	Polyamide (PA66)
Flammability class per UL94	V0
Fire load	0.148 MJ
Weight	5.7 g

Commercial data

Product Group	3 (Multi Conn. System)
PU (SPU)	25 pcs
Packaging type	Box
Country of origin	DE
GTIN	4017332259798
Customs tariff number	39269097900

Product Classification

UNSPSC	39121421
eCl@ss 10.0	27-14-11-92
eCl@ss 9.0	27-44-04-92
ETIM 9.0	EC002848
ETIM 10.0	EC002848
ECCN	NO US CLASSIFICATION

Environmental Product Compliance

RoHS Compliance Status	Compliant, No Exemption
------------------------	-------------------------

Approvals / Certificates

Approvals for marine applications



Approval	Standard	Certificate Name
ABS American Bureau of Shipping	-	24-0095975-PDA

Downloads

Environmental Product Compliance

Compliance Search

Environmental Product Compliance 232-663



Documentation

Additional Information

Technical Section

03.04.2019

pdf

2027.26 KB



CAD/CAE-Data

CAD data

2D/3D Models 232-663



CAE data

EPLAN Data Portal 232-663



ZUKEN Portal 232-663



1 Compatible Products

1.1 Optional Accessories

1.1.1 Marking

1.1.1.1 Marker



[Item No.: 793-5501/000-006](#)

WMB marking card; as card; for terminal block width 5 - 17.5 mm; stretchable 5 - 5.2 mm; plain; snap-on type; blue



[Item No.: 793-5501/000-014](#)

WMB marking card; as card; for terminal block width 5 - 17.5 mm; stretchable 5 - 5.2 mm; plain; snap-on type; brown



[Item No.: 793-5501/000-007](#)

WMB marking card; as card; for terminal block width 5 - 17.5 mm; stretchable 5 - 5.2 mm; plain; snap-on type; gray



[Item No.: 793-5501/000-023](#)

WMB marking card; as card; for terminal block width 5 - 17.5 mm; stretchable 5 - 5.2 mm; plain; snap-on type; green



[Item No.: 793-5501/000-017](#)

WMB marking card; as card; for terminal block width 5 - 17.5 mm; stretchable 5 - 5.2 mm; plain; snap-on type; light green



[Item No.: 793-5501/000-012](#)

WMB marking card; as card; for terminal block width 5 - 17.5 mm; stretchable 5 - 5.2 mm; plain; snap-on type; orange



[Item No.: 793-5501/000-005](#)

WMB marking card; as card; for terminal block width 5 - 17.5 mm; stretchable 5 - 5.2 mm; plain; snap-on type; red



[Item No.: 793-5501/000-024](#)

WMB marking card; as card; for terminal block width 5 - 17.5 mm; stretchable 5 - 5.2 mm; plain; snap-on type; violet



[Item No.: 793-5501](#)

WMB marking card; as card; for terminal block width 5 - 17.5 mm; stretchable 5 - 5.2 mm; plain; snap-on type; white



[Item No.: 793-5501/000-002](#)

WMB marking card; as card; for terminal block width 5 - 17.5 mm; stretchable 5 - 5.2 mm; plain; snap-on type; yellow



[Item No.: 793-501/000-006](#)

WMB marking card; as card; not stretchable; plain; snap-on type; blue



[Item No.: 793-501/000-007](#)

WMB marking card; as card; not stretchable; plain; snap-on type; gray



[Item No.: 793-501/000-023](#)

WMB marking card; as card; not stretchable; plain; snap-on type; green



[Item No.: 793-501/000-017](#)

WMB marking card; as card; not stretchable; plain; snap-on type; light green



[Item No.: 793-501/000-012](#)

WMB marking card; as card; not stretchable; plain; snap-on type; orange



[Item No.: 793-501/000-005](#)

WMB marking card; as card; not stretchable; plain; snap-on type; red



[Item No.: 793-501/000-024](#)

WMB marking card; as card; not stretchable; plain; snap-on type; violet



[Item No.: 793-501](#)

WMB marking card; as card; not stretchable; plain; snap-on type; white



[Item No.: 793-501/000-002](#)

WMB marking card; as card; not stretchable; plain; snap-on type; yellow



[Item No.: 2009-115/000-006](#)

WMB-Inline; for Smart Printer; 1500 pieces on roll; stretchable 5 - 5.2 mm; plain; snap-on type; blue

1.1.1.1 Marker



Item No.: 2009-115/000-007

WMB-Inline; for Smart Printer; 1500 pieces on roll; stretchable 5 - 5.2 mm; plain; snap-on type; gray



Item No.: 2009-115/000-023

WMB-Inline; for Smart Printer; 1500 pieces on roll; stretchable 5 - 5.2 mm; plain; snap-on type; green



Item No.: 2009-115/000-017

WMB-Inline; for Smart Printer; 1500 pieces on roll; stretchable 5 - 5.2 mm; plain; snap-on type; light green



Item No.: 2009-115/000-012

WMB-Inline; for Smart Printer; 1500 pieces on roll; stretchable 5 - 5.2 mm; plain; snap-on type; orange



Item No.: 2009-115/000-024

WMB-Inline; for Smart Printer; 1500 pieces on roll; stretchable 5 - 5.2 mm; plain; snap-on type; violet



Item No.: 2009-115

WMB-Inline; for Smart Printer; 1500 pieces on roll; stretchable 5 - 5.2 mm; plain; snap-on type; white



Item No.: 2009-115/000-002

WMB-Inline; for Smart Printer; 1500 pieces on roll; stretchable 5 - 5.2 mm; plain; snap-on type; yellow

Installation Notes

Application

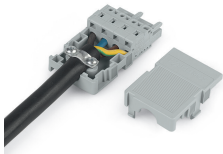

2- to 3-pole; only suitable for cable ties;
max. 3.6 mm cable tie width
4- to 16-pole; suitable for cable clamp, covers (included)
Cable ties and binding tools are not offered by WAGO.

Installation

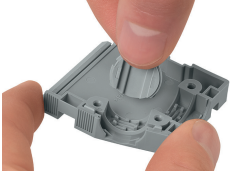

Snapping a cover into the unused cable outlet.



Strain relief housing shown with a male connector equipped with CAGE CLAMP®

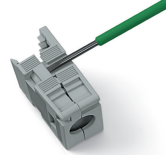

Disassembling a strain relief housing is only possible using an operating tool (e.g., 210-719).