

LEIA-S

~3° spot beam

SPECIFICATION:

Dimensions	Ø 50.0
Height	53 mm
Fastening	pin, screw
ROHS compliant	yes ⓘ

MATERIALS:

Component	Type	Material	Colour	Finish	Length (mm)
LEIA-HLD	Holder	HRPC	white		
LEIA-S	Single lens	PMMA			

ORDERING INFORMATION:

Quantities for one set:

Single lens	1
Holder	1



Component		Qty in box	MOQ	MPQ	Box weight (kg)
F16199_LEIA-S	Single lens	240	40	40	8.2
» Box size: 480 x 280 x 300 mm					
F16213_LEIA-HLD	Holder	400	40	20	5.8
» Box size: 398 x 298 x 265 mm					

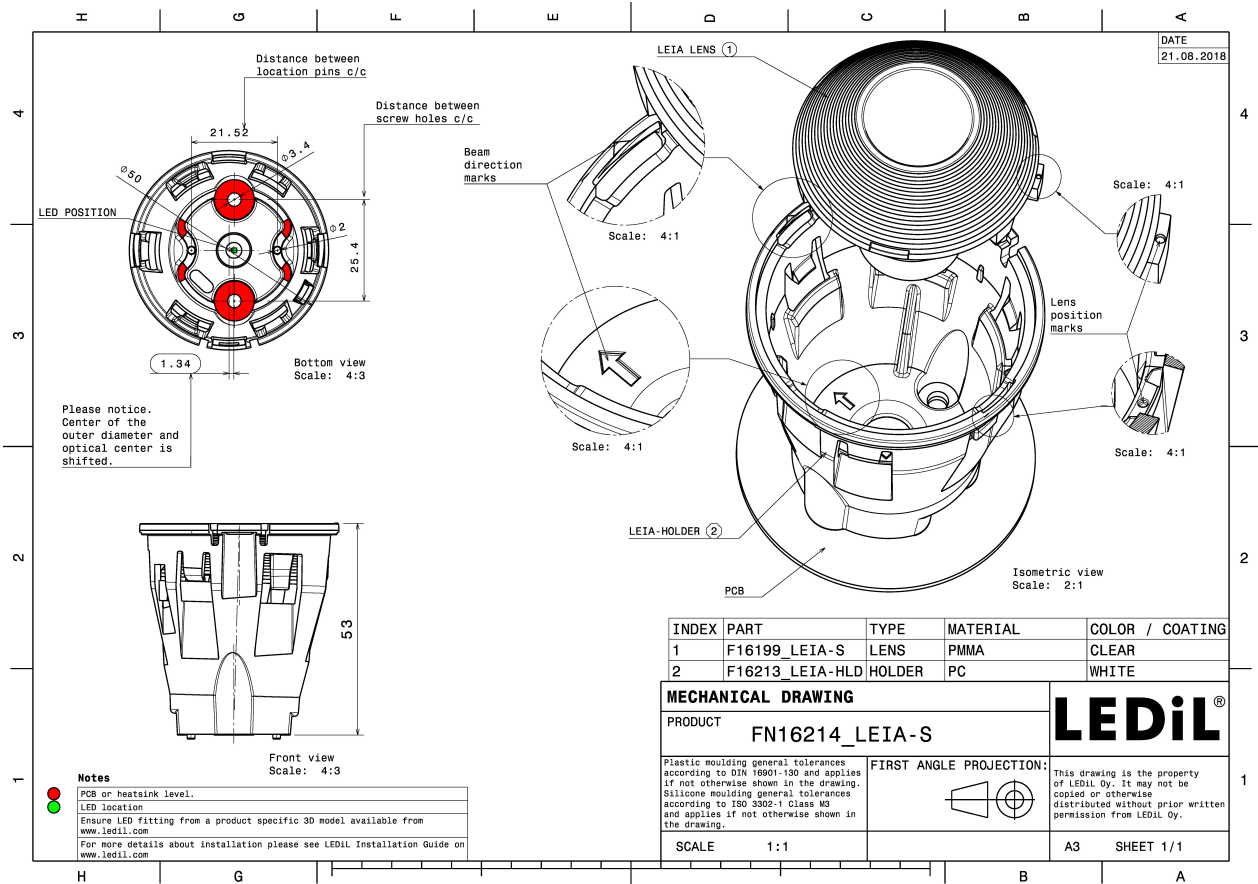

See also our general installation guide: www.ledil.com/installation_guide

OPTICAL RESULTS (MEASURED):



LED XHP35 HD
FWHM / FWTM 52.0 + 6.0° / 77.0 + 15.0°
Efficiency 45 %
Peak intensity 2.6 cd/lm
LEDs/each optic 1
Light colour/type White
Required components:
 F16629_LEIA-SUB-O

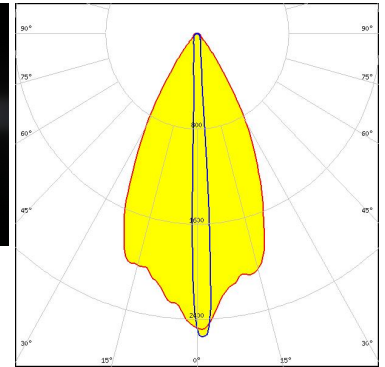

Light distribution files



LED XHP35 HD
FWHM / FWTM 6.0° / 9.0°
Efficiency 49 %
Peak intensity 22.8 cd/lm
LEDs/each optic 1
Light colour/type White
Required components:

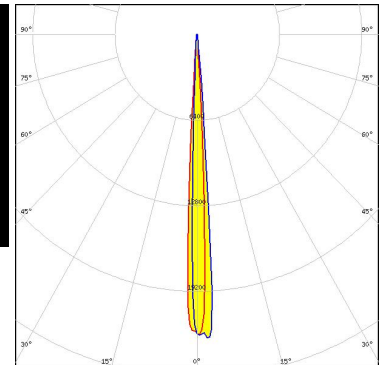

Light distribution files



LED XHP35 HD
FWHM / FWTM 6.0° / 9.0°
Efficiency 50 %
Peak intensity 22.6 cd/lm
LEDs/each optic 1
Light colour/type White
Required components:

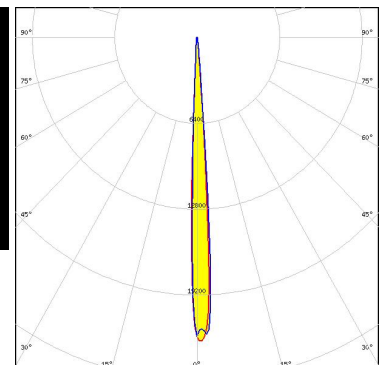
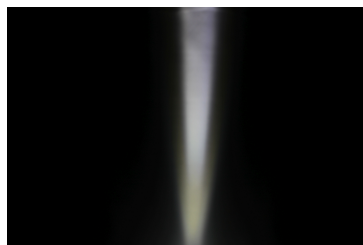

Light distribution files

OPTICAL RESULTS (MEASURED):



LED XHP35 HI
 FWHM / FWTM 4.0° / 7.0°
 Efficiency 52 %
 Peak intensity 43.2 cd/lm
 LEDs/each optic 1
 Light colour/type White
 Required components:

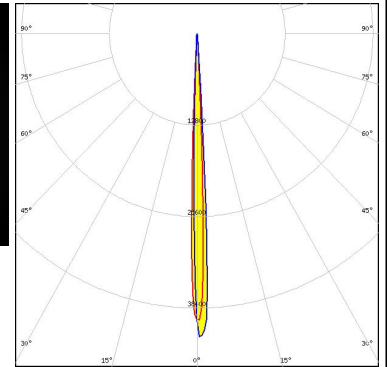

Light distribution files



LED XHP35 HI
 FWHM / FWTM 50.0 + 5.0° / 76.0 + 11.0°
 Efficiency 47 %
 Peak intensity 3.6 cd/lm
 LEDs/each optic 1
 Light colour/type White
 Required components:
 F16629_LEIA-SUB-O

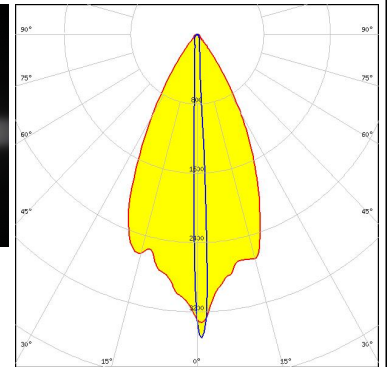

Light distribution files



LED XHP50.2
 FWHM / FWTM 8.0° / 14.0°
 Efficiency 48 %
 Peak intensity 13 cd/lm
 LEDs/each optic 1
 Light colour/type White
 Required components:

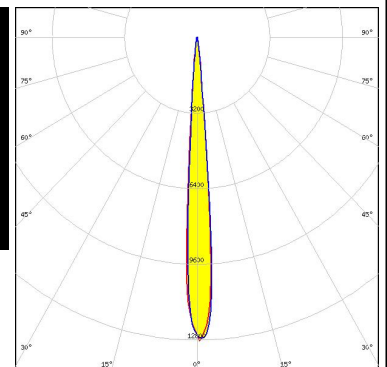

Light distribution files

OPTICAL RESULTS (MEASURED):



LED XHP50.2
FWHM / FWTM 52.0 + 8.0° / 78.0 + 20.0°
Efficiency 42 %
Peak intensity 1.8 cd/lm
LEDs/each optic 1
Light colour/type White
Required components:
 F16629_LEIA-SUB-O

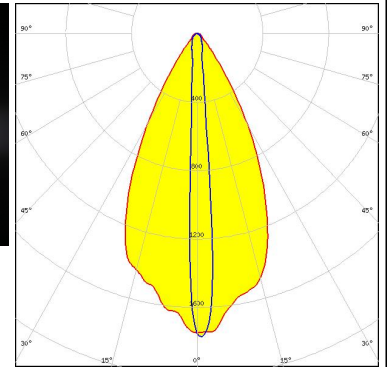

Light distribution files



LED XP-E2
FWHM / FWTM 2.6° / 5.7°
Efficiency 59 %
Peak intensity 128.3 cd/lm
LEDs/each optic 1
Light colour/type White
Required components:

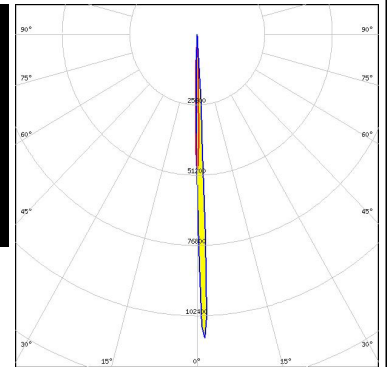
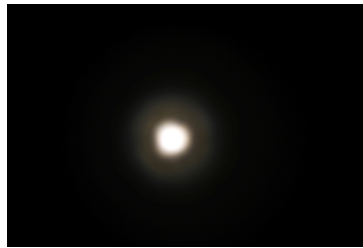

Light distribution files



LED XP-G2
FWHM / FWTM 4.0° / 6.0°
Efficiency 50 %
Peak intensity 63.4 cd/lm
LEDs/each optic 1
Light colour/type White
Required components:

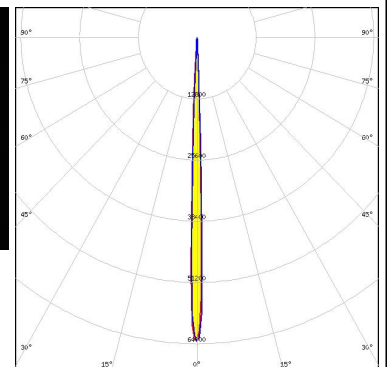

Light distribution files

OPTICAL RESULTS (MEASURED):



LED XP-G2
FWHM / FWTM 57.0 + 4.0° / 82.0 + 9.0°
Efficiency 40 %
Peak intensity 4.6 cd/lm
LEDs/each optic 1
Light colour/type White
Required components:
 F16629_LEIA-SUB-O

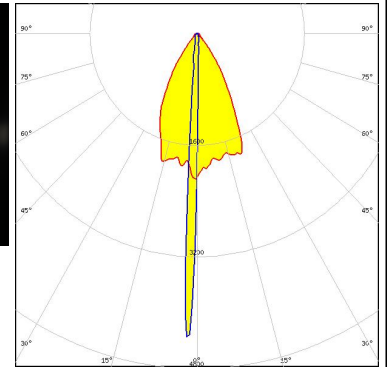

Light distribution files



LED XP-G3
FWHM / FWTM 50.0 + 4.0° / 76.0 + 9.0°
Efficiency 47 %
Peak intensity 3.7 cd/lm
LEDs/each optic 1
Light colour/type White
Required components:
 F16629_LEIA-SUB-O

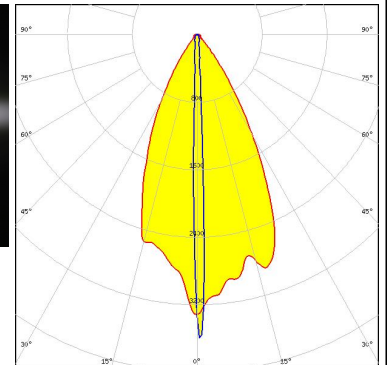

Light distribution files



LED XP-G3
FWHM / FWTM 4.0° / 7.0°
Efficiency 51 %
Peak intensity 48.5 cd/lm
LEDs/each optic 1
Light colour/type White
Required components:

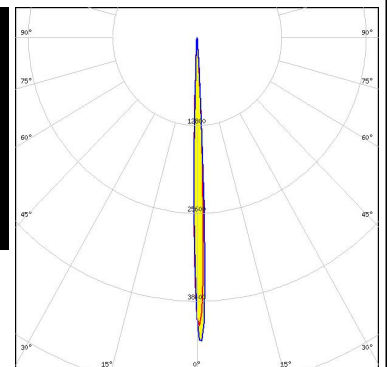

Light distribution files

OPTICAL RESULTS (MEASURED):



LED XP-L2
FWHM / FWTM 51.0 + 6.0° / 77.0 + 16.0°
Efficiency 49 %
Peak intensity 2.8 cd/lm
LEDs/each optic 1
Light colour/type White
Required components:
 F16629_LEIA-SUB-O

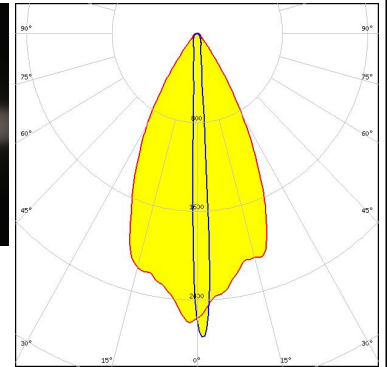

Light distribution files



LED XQ-E HD
FWHM / FWTM 50.0 + 3.0° / 76.0 + 9.0°
Efficiency 42 %
Peak intensity 4.6 cd/lm
LEDs/each optic 1
Light colour/type White
Required components:
 F16629_LEIA-SUB-O

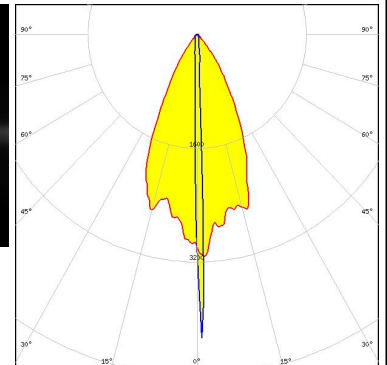
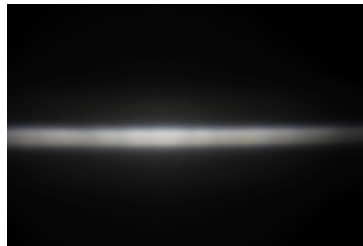

Light distribution files



LED XQ-E HD
FWHM / FWTM 3.0° / 6.0°
Efficiency 47 %
Peak intensity 91 cd/lm
LEDs/each optic 1
Light colour/type White
Required components:

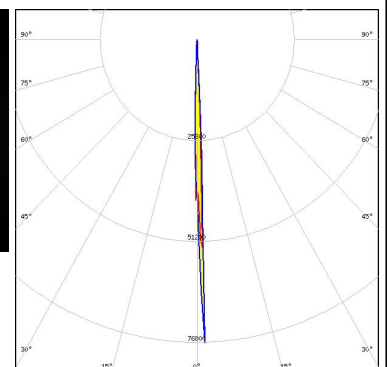

Light distribution files

OPTICAL RESULTS (MEASURED):



LED XQ-E HI
 FWHM / FWTM 2.0° / 4.0°
 Efficiency 48 %
 Peak intensity 112.6 cd/lm
 LEDs/each optic 1
 Light colour/type White
 Required components:

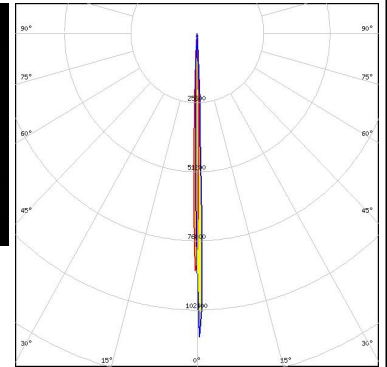
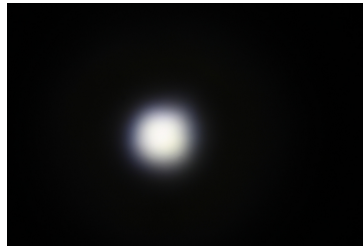

Light distribution files



LED XQ-E HI
 FWHM / FWTM 52.0 + 3.0° / 79.0 + 9.0°
 Efficiency 44 %
 Peak intensity 6 cd/lm
 LEDs/each optic 1
 Light colour/type White
 Required components:
 F16629_LEIA-SUB-O

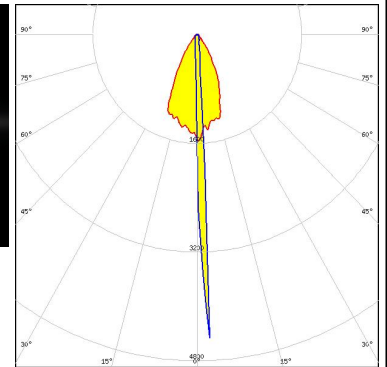

Light distribution files



LED XT-E
 FWHM / FWTM 50.0 + 4.0° / 76.0 + 11.0°
 Efficiency 46 %
 Peak intensity 6.2 cd/lm
 LEDs/each optic 1
 Light colour/type White
 Required components:
 F16629_LEIA-SUB-O

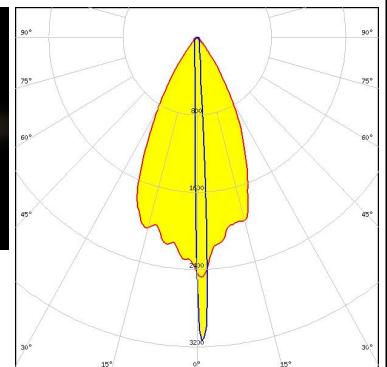

Light distribution files

OPTICAL RESULTS (MEASURED):



LED XT-E
FWHM / FWTM 4.0° / 7.0°
Efficiency 49 %
Peak intensity 42.9 cd/lm
LEDs/each optic 1
Light colour/type White
Required components:

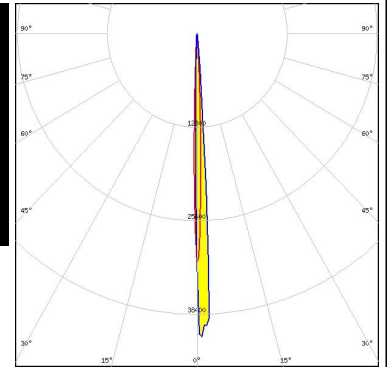

Light distribution files



LED LUXEON 5050 Round LES
FWHM / FWTM 51.0 + 7.0° / 78.0 + 18.0°
Efficiency 46 %
Peak intensity 2.2 cd/lm
LEDs/each optic 1
Light colour/type White
Required components:
 F16629_LEIA-SUB-O

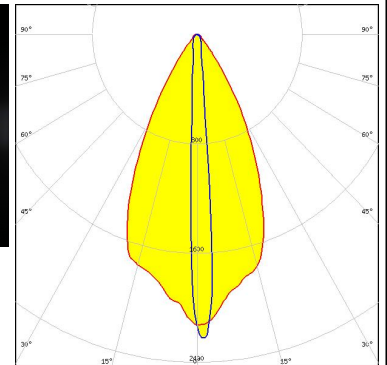

Light distribution files



LED LUXEON 5050 Round LES
FWHM / FWTM 7.0° / 11.0°
Efficiency 51 %
Peak intensity 16.7 cd/lm
LEDs/each optic 1
Light colour/type White
Required components:

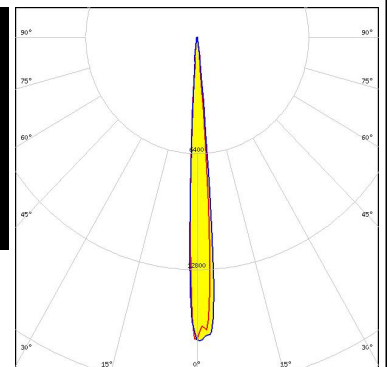

Light distribution files

OPTICAL RESULTS (MEASURED):



LED LUXEON CZ
FWHM / FWTM 51.0 + 3.0° / 76.0 + 7.0°
Efficiency 48 %
Peak intensity 6.9 cd/lm
LEDs/each optic 1
Light colour/type White
Required components:
 F16629_LEIA-SUB-O

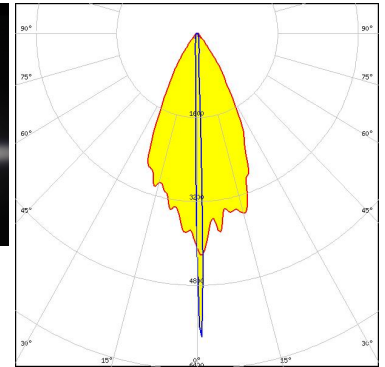

Light distribution files



LED LUXEON CZ
FWHM / FWTM 2.0° / 5.0°
Efficiency 55 %
Peak intensity 157 cd/lm
LEDs/each optic 1
Light colour/type White
Required components:

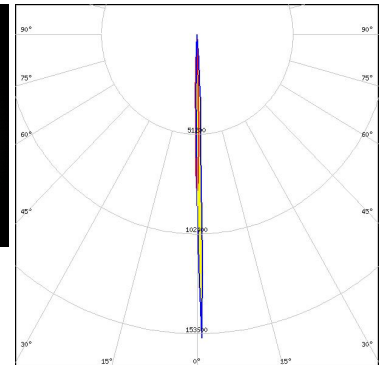
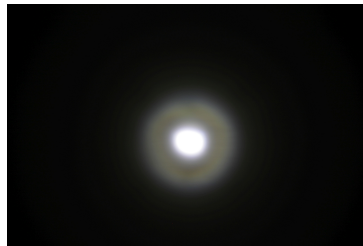

Light distribution files



LED LUXEON MZ
FWHM / FWTM 50.0 + 6.0° / 77.0 + 15.0°
Efficiency 45 %
Peak intensity 2.8 cd/lm
LEDs/each optic 1
Light colour/type White
Required components:
 F16629_LEIA-SUB-O

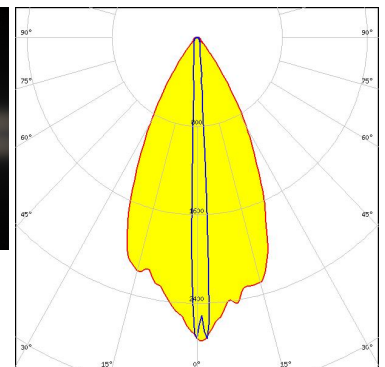
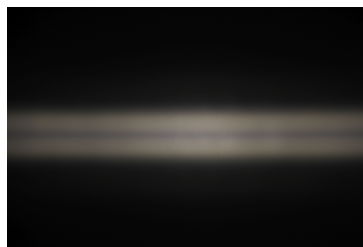

Light distribution files

OPTICAL RESULTS (MEASURED):



LED LUXEON MZ
FWHM / FWTM 6.0° / 9.0°
Efficiency 49 %
Peak intensity 27.5 cd/lm
LEDs/each optic 1
Light colour/type White
Required components:

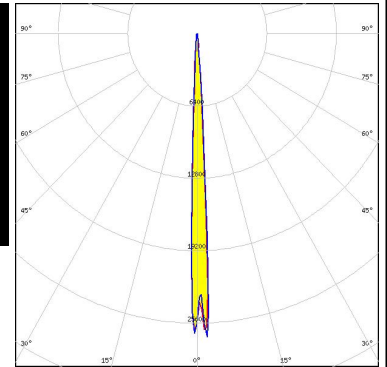
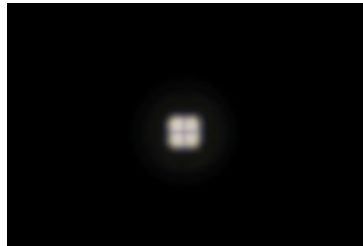

Light distribution files



LED LUXEON TX
FWHM / FWTM 50.0 + 4.0° / 76.0 + 9.0°
Efficiency 48 %
Peak intensity 4 cd/lm
LEDs/each optic 1
Light colour/type White
Required components:
 F16629_LEIA-SUB-O

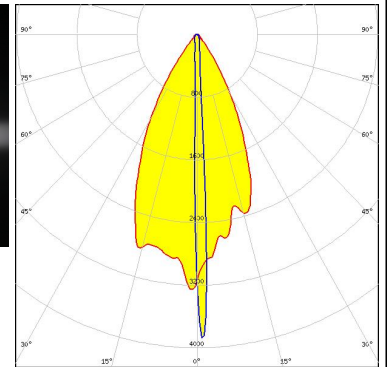

Light distribution files



LED LUXEON TX
FWHM / FWTM 4.0° / 7.0°
Efficiency 51 %
Peak intensity 58.4 cd/lm
LEDs/each optic 1
Light colour/type White
Required components:

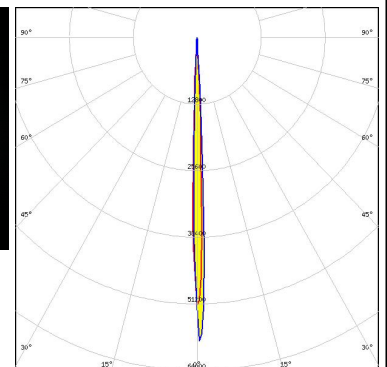

Light distribution files

OPTICAL RESULTS (MEASURED):



LED LUXEON V
FWHM / FWTM 6.0° / 9.0°
Efficiency 53 %
Peak intensity 27.7 cd/lm
LEDs/each optic 1
Light colour/type White
Required components:

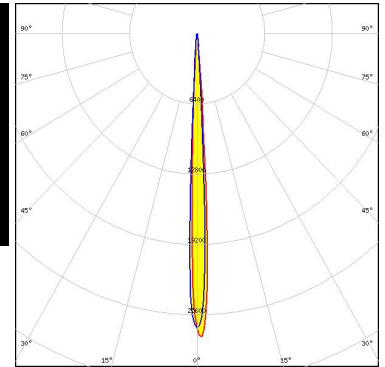
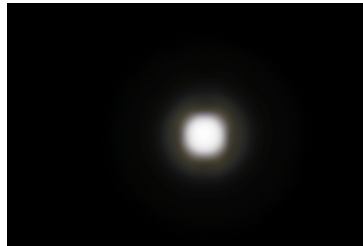

Light distribution files



LED LUXEON V
FWHM / FWTM 51.0 + 6.0° / 77.0 + 15.0°
Efficiency 49 %
Peak intensity 2.9 cd/lm
LEDs/each optic 1
Light colour/type White
Required components:
 F16629_LEIA-SUB-O

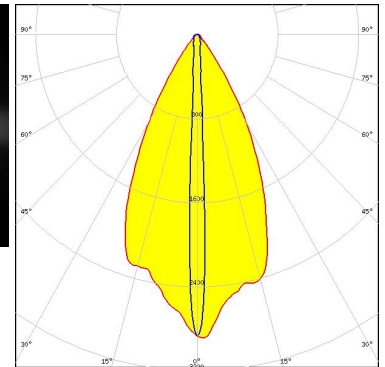

Light distribution files



LED LUXEON Z
FWHM / FWTM 2.0° / 5.0°
Efficiency 50 %
Peak intensity 131 cd/lm
LEDs/each optic 1
Light colour/type White
Required components:

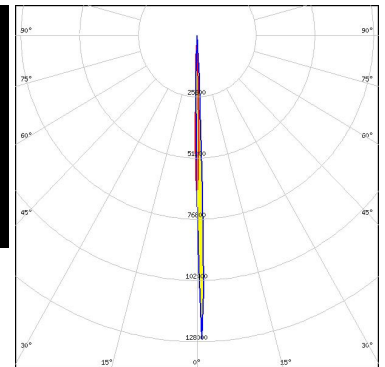
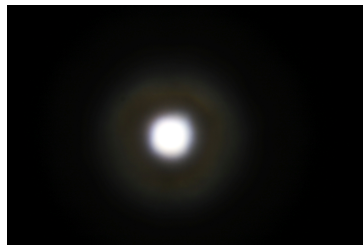

Light distribution files

OPTICAL RESULTS (MEASURED):



LED LUXEON Z ES
FWHM / FWTM 3.0° / 6.0°
Efficiency 55 %
Peak intensity 98.2 cd/lm
LEDs/each optic 1
Light colour/type White
Required components:

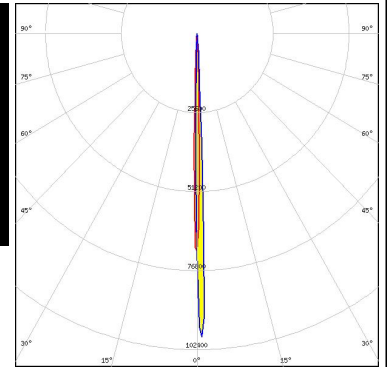

Light distribution files



LED LUXEON Z ES
FWHM / FWTM 49.0 + 3.0° / 76.0 + 7.0°
Efficiency 49 %
Peak intensity 5.7 cd/lm
LEDs/each optic 1
Light colour/type White
Required components:
 F16629_LEIA-SUB-O

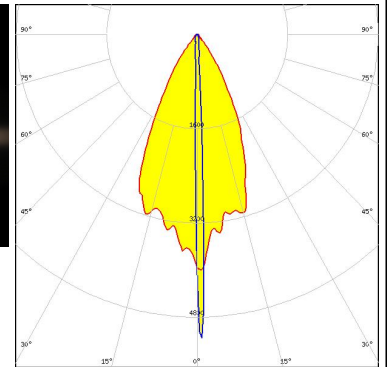

Light distribution files



LED NCSxE17A
FWHM / FWTM 3.0° / 6.0°
Efficiency 40 %
Peak intensity 73.7 cd/lm
LEDs/each optic 1
Light colour/type White
Required components:

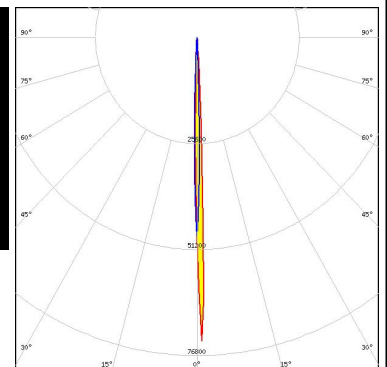

Light distribution files

OPTICAL RESULTS (MEASURED):



LED NCSxE17A
 FWHM / FWTM 50.0 + 3.0° / 77.0 + 7.0°
 Efficiency 36 %
 Peak intensity 4.1 cd/lm
 LEDs/each optic 1
 Light colour/type White
 Required components:
 F16629_LEIA-SUB-O

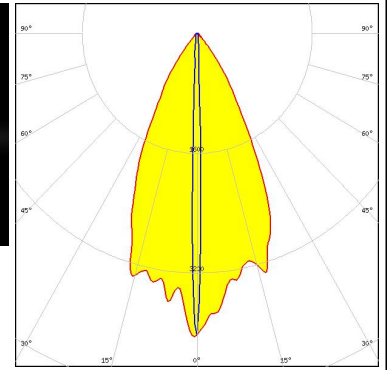
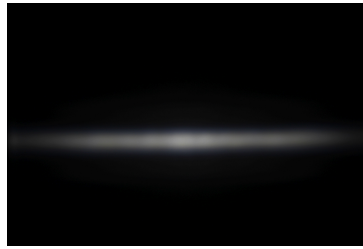

Light distribution files



LED NVSW219F-V2
 FWHM / FWTM 4.0° / 7.0°
 Efficiency 50 %
 Peak intensity 47.5 cd/lm
 LEDs/each optic 1
 Light colour/type White
 Required components:

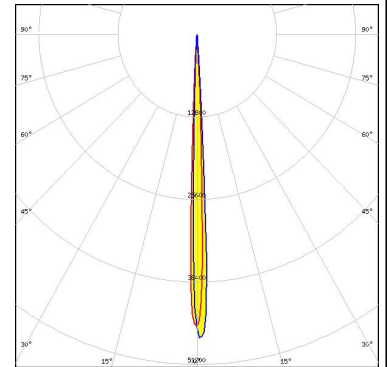

Light distribution files



LED NVSW219F-V2
 FWHM / FWTM 51.0 + 5.0° / 76.0 + 10.0°
 Efficiency 48 %
 Peak intensity 3.8 cd/lm
 LEDs/each optic 1
 Light colour/type White
 Required components:
 F16629_LEIA-SUB-O

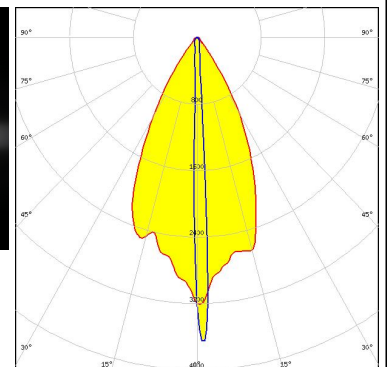
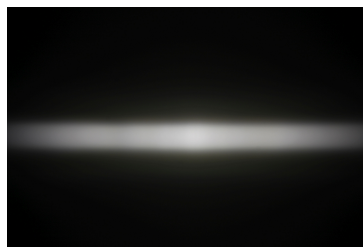

Light distribution files

OPTICAL RESULTS (MEASURED):



LED NVSW319B
 FWHM / FWTM 5.0° / 8.0°
 Efficiency 52 %
 Peak intensity 36.8 cd/lm
 LEDs/each optic 1
 Light colour/type White
 Required components:

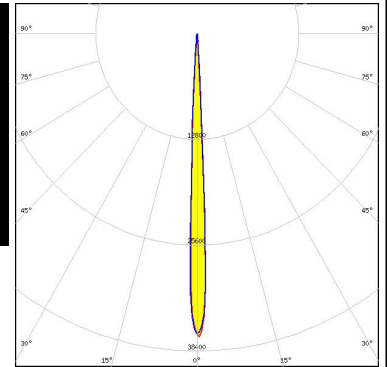

Light distribution files



LED NVSW319B
 FWHM / FWTM 50.0 + 5.0° / 76.0 + 13.0°
 Efficiency 46 %
 Peak intensity 3.4 cd/lm
 LEDs/each optic 1
 Light colour/type White
 Required components:
 F16629_LEIA-SUB-O

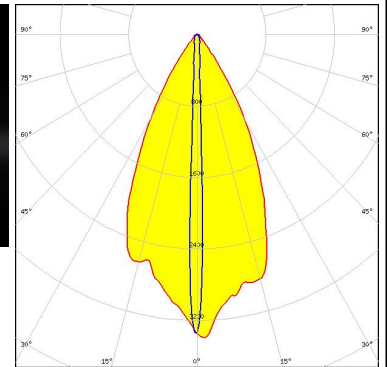
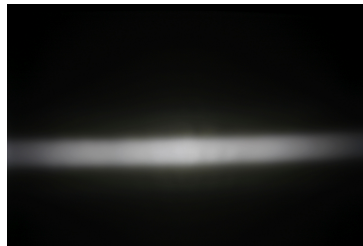

Light distribution files



LED NVSxE21A
 FWHM / FWTM 49.0 + 4.0° / 77.0 + 13.0°
 Efficiency 41 %
 Peak intensity 3.5 cd/lm
 LEDs/each optic 1
 Light colour/type White
 Required components:
 F16629_LEIA-SUB-O

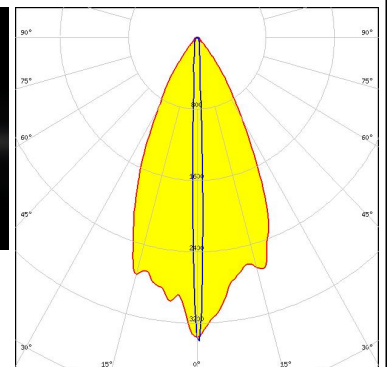

Light distribution files

OPTICAL RESULTS (MEASURED):



LED NVSxE21A
 FWHM / FWTM 3.0° / 7.0°
 Efficiency 46 %
 Peak intensity 51 cd/lm
 LEDs/each optic 1
 Light colour/type White
 Required components:

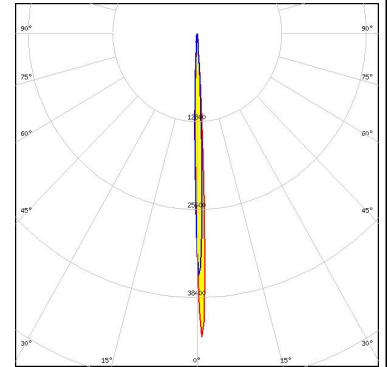

Light distribution files



LED NVSxx19B/NVSxx19C
 FWHM / FWTM 4.0° / 7.0°
 Efficiency 49 %
 Peak intensity 48.7 cd/lm
 LEDs/each optic 1
 Light colour/type White
 Required components:

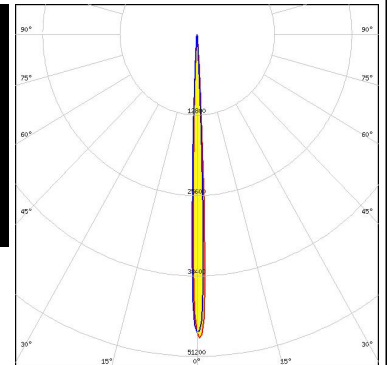
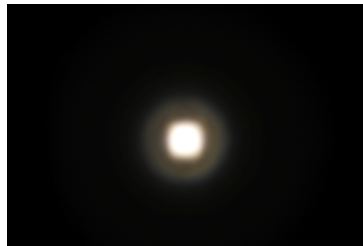

Light distribution files



LED NVSxx19B/NVSxx19C
 FWHM / FWTM 50.0 + 4.0° / 76.0 + 9.0°
 Efficiency 44 %
 Peak intensity 3.9 cd/lm
 LEDs/each optic 1
 Light colour/type White
 Required components:
 F16629_LEIA-SUB-O

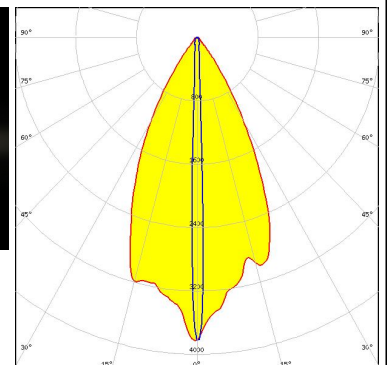
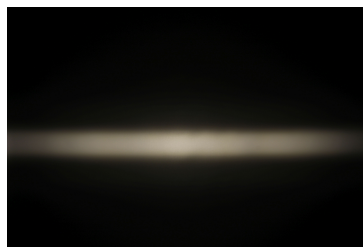

Light distribution files

OPTICAL RESULTS (MEASURED):

OSRAM
Opto Semiconductors

LED OSCONIQ P 3737 (2W) PUSRA1
 FWHM / FWTM 3.0° / 7.0°
 Efficiency 54 %
 Peak intensity 62.4 cd/lm
 LEDs/each optic 1
 Light colour/type White
 Required components:

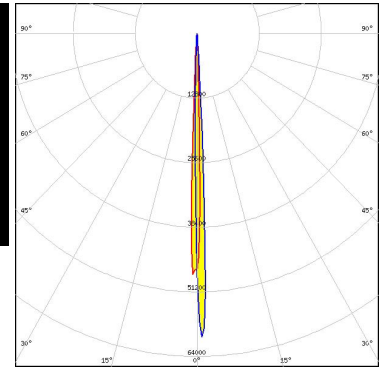
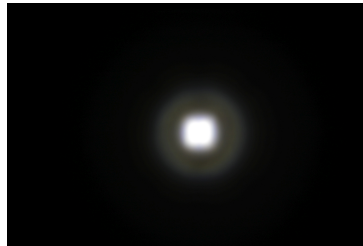

Light distribution files

OSRAM
Opto Semiconductors

LED OSCONIQ P 3737 (2W) PUSRA1
 FWHM / FWTM 50.0 + 4.0° / 76.0 + 9.0°
 Efficiency 49 %
 Peak intensity 4.5 cd/lm
 LEDs/each optic 1
 Light colour/type White
 Required components:
 F16629_LEIA-SUB-O

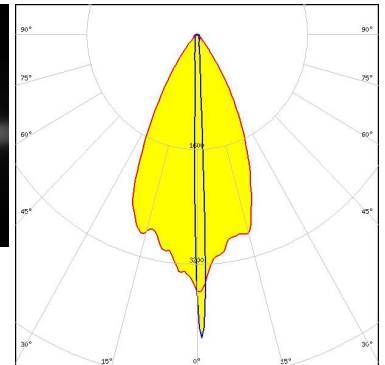

Light distribution files

OSRAM
Opto Semiconductors

LED OSCONIQ P 3737 (3W) PUSTA1
 FWHM / FWTM 51.0 + 5.0° / 76.0 + 14.0°
 Efficiency 48 %
 Peak intensity 3.4 cd/lm
 LEDs/each optic 1
 Light colour/type White
 Required components:
 F16629_LEIA-SUB-O

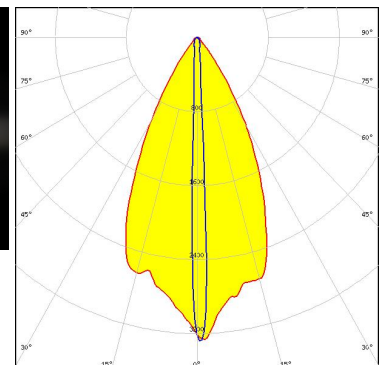
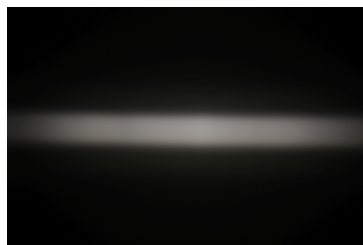

Light distribution files

OPTICAL RESULTS (MEASURED):

OSRAM
Opto Semiconductors

LED OSCONIQ P 3737 (3W) PUSTA1
 FWHM / FWTM 5.0° / 8.0°
 Efficiency 53 %
 Peak intensity 36 cd/lm
 LEDs/each optic 1
 Light colour/type White
 Required components:

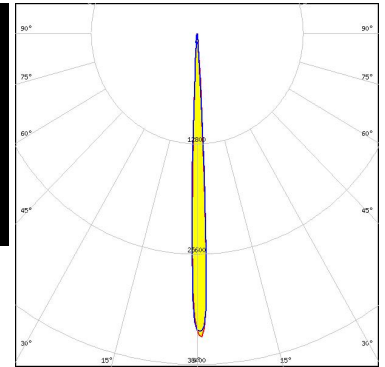

Light distribution files

OSRAM
Opto Semiconductors

LED OSLO Boost HX (KW CULPM1.TG)
 FWHM / FWTM 3.0° / 5.0°
 Efficiency 54 %
 Peak intensity 96.6 cd/lm
 LEDs/each optic 1
 Light colour/type White
 Required components:

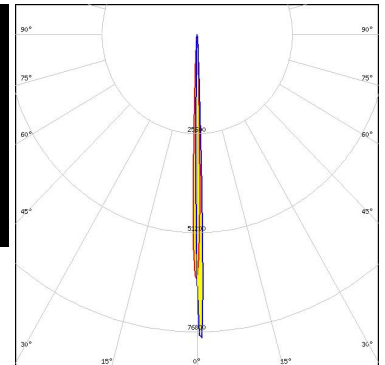
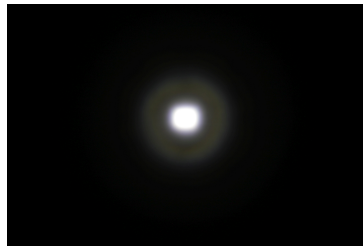

Light distribution files

OSRAM
Opto Semiconductors

LED OSLO Square CSSRM2/CSSRM3
 FWHM / FWTM 50.0 + 4.0° / 75.0 + 8.0°
 Efficiency 46 %
 Peak intensity 4.4 cd/lm
 LEDs/each optic 1
 Light colour/type White
 Required components:
 F16629_LEIA-SUB-O

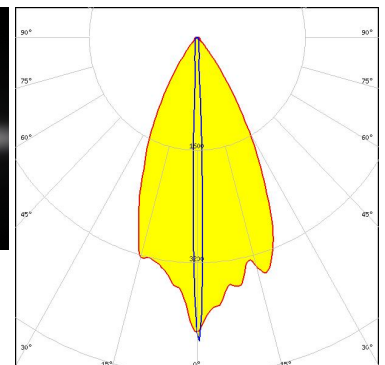

Light distribution files

OPTICAL RESULTS (MEASURED):

OSRAM
Opto Semiconductors

LED OSLON Square CSSRM2/CSSRM3
 FWHM / FWTM 4.0° / 7.0°
 Efficiency 49 %
 Peak intensity 64.8 cd/lm
 LEDs/each optic 1
 Light colour/type White
 Required components:

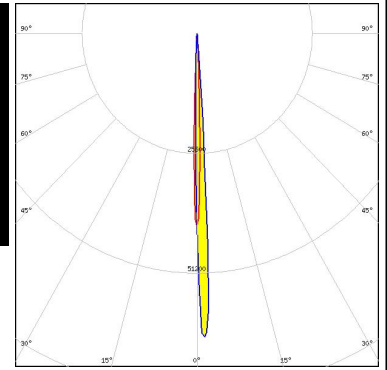
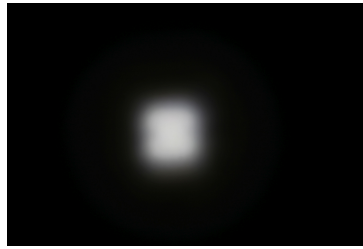

Light distribution files

OSRAM
Opto Semiconductors

LED OSLON Square PC
 FWHM / FWTM 52.0 + 4.0° / 77.0 + 9.0°
 Efficiency 42 %
 Peak intensity 3.9 cd/lm
 LEDs/each optic 1
 Light colour/type White
 Required components:
 F16629_LEIA-SUB-O

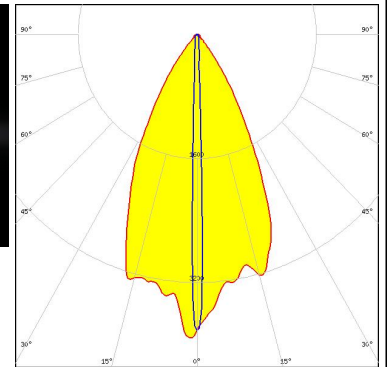
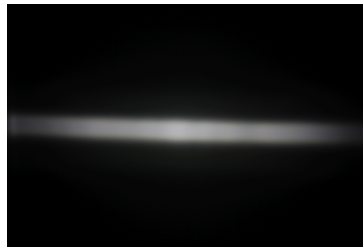

Light distribution files

OSRAM
Opto Semiconductors

LED OSLON SSL 150
 FWHM / FWTM 2.0° / 5.0°
 Efficiency 46 %
 Peak intensity 122 cd/lm
 LEDs/each optic 1
 Light colour/type White
 Required components:

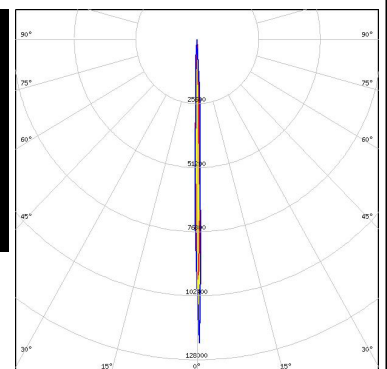

Light distribution files

OPTICAL RESULTS (MEASURED):

OSRAM
Opto Semiconductors

LED OSLON SSL 150
FWHM / FWTM 47.0 + 3.0° / 73.0 + 7.0°
Efficiency 40 %
Peak intensity 4.9 cd/lm
LEDs/each optic 1
Light colour/type White
Required components:
F16629_LEIA-SUB-O

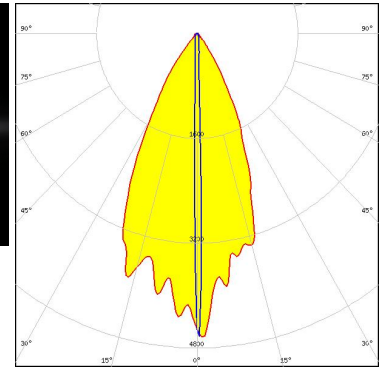

Light distribution files

OSRAM
Opto Semiconductors

LED OSLON SSL 80
FWHM / FWTM 3.0° / 6.0°
Efficiency 62 %
Peak intensity 106.7 cd/lm
LEDs/each optic 1
Light colour/type White
Required components:

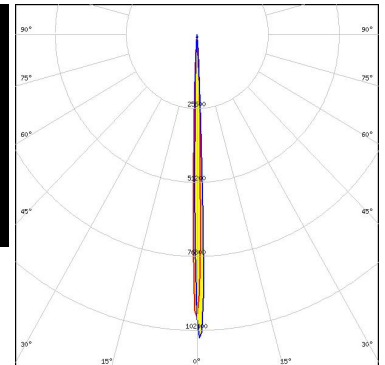

Light distribution files

OSRAM
Opto Semiconductors

LED OSLON SSL 80
FWHM / FWTM 51.0 + 3.0° / 77.0 + 7.0°
Efficiency 56 %
Peak intensity 6.5 cd/lm
LEDs/each optic 1
Light colour/type White
Required components:
F16629_LEIA-SUB-O

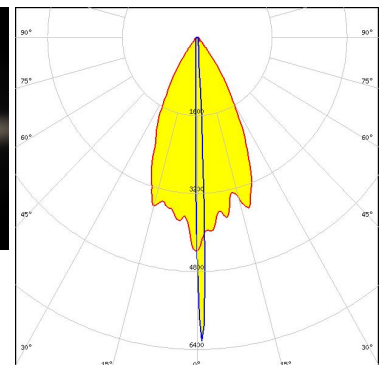

Light distribution files

OPTICAL RESULTS (MEASURED):

OSRAM
Opto Semiconductors

LED OSTAR Projection Compact (KW.CSLNM1.TG)
 FWHM / FWTM 3.0° / 5.0°
 Efficiency 49 %
 Peak intensity 120.8 cd/lm
 LEDs/each optic 1
 Light colour/type White
 Required components:

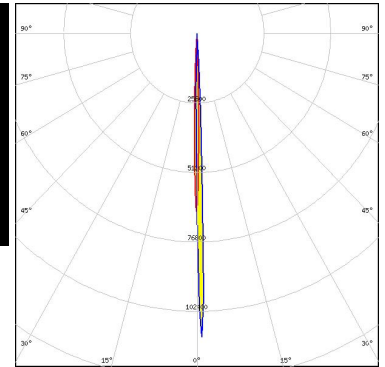

Light distribution files

SAMSUNG

LED LH231B
 FWHM / FWTM 4.0° / 7.0°
 Efficiency 50 %
 Peak intensity 43.6 cd/lm
 LEDs/each optic 1
 Light colour/type White
 Required components:

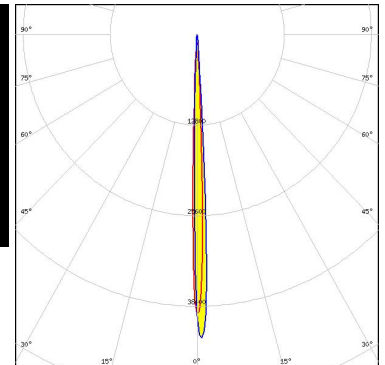

Light distribution files

SAMSUNG

LED LH231B
 FWHM / FWTM 50.0 + 4.0° / 76.0 + 13.0°
 Efficiency 46 %
 Peak intensity 3.5 cd/lm
 LEDs/each optic 1
 Light colour/type White
 Required components:
 F16629_LEIA-SUB-O

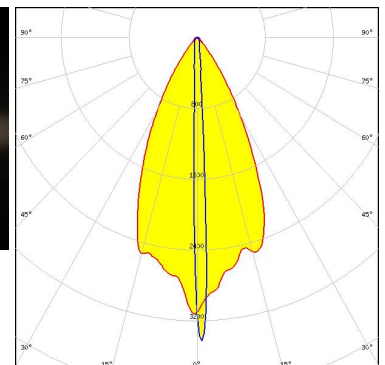
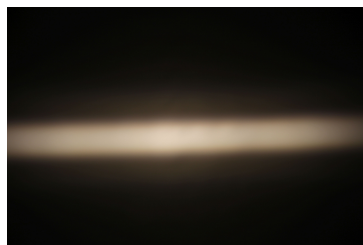

Light distribution files

OPTICAL RESULTS (MEASURED):

SAMSUNG

LED LH351B
 FWHM / FWTM 4.0° / 7.0°
 Efficiency 55 %
 Peak intensity 54.4 cd/lm
 LEDs/each optic 1
 Light colour/type White
 Required components:

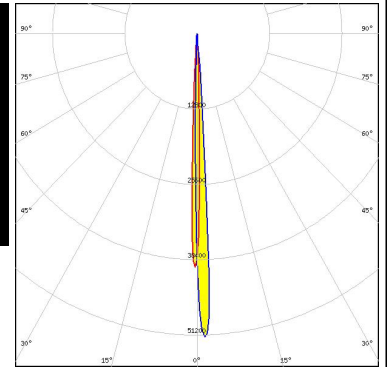

Light distribution files

SAMSUNG

LED LH351B
 FWHM / FWTM 52.0 + 4.0° / 77.0 + 10.0°
 Efficiency 50 %
 Peak intensity 4.3 cd/lm
 LEDs/each optic 1
 Light colour/type White
 Required components:
 F16629_LEIA-SUB-O

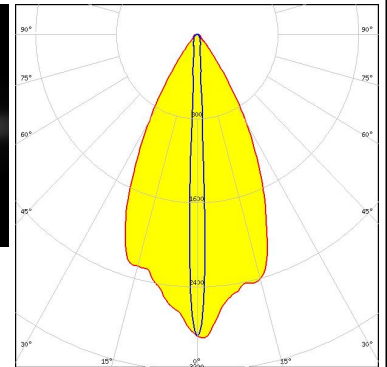
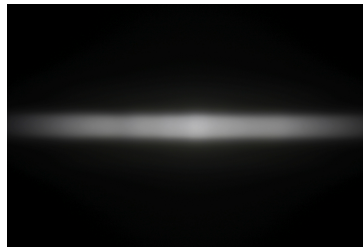

Light distribution files

SAMSUNG

LED LH351C
 FWHM / FWTM 4.0° / 7.0°
 Efficiency 57 %
 Peak intensity 46.1 cd/lm
 LEDs/each optic 1
 Light colour/type White
 Required components:

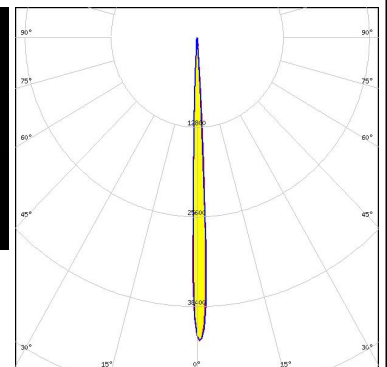

Light distribution files

OPTICAL RESULTS (MEASURED):

SAMSUNG

LED LH351C
 FWHM / FWTM 50.0 + 5.0° / 76.0 + 12.0°
 Efficiency 52 %
 Peak intensity 3.9 cd/lm
 LEDs/each optic 1
 Light colour/type White
 Required components:
 F16629_LEIA-SUB-O

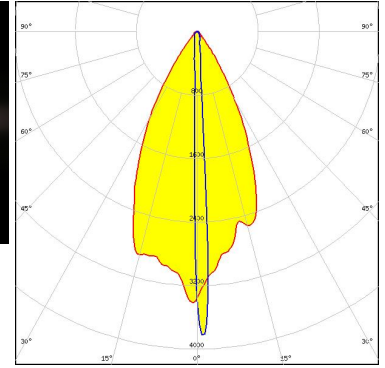

Light distribution files

SAMSUNG

LED LH351D
 FWHM / FWTM 53.0 + 5.0° / 77.0 + 14.0°
 Efficiency 50 %
 Peak intensity 3.1 cd/lm
 LEDs/each optic 1
 Light colour/type White
 Required components:
 F16629_LEIA-SUB-O

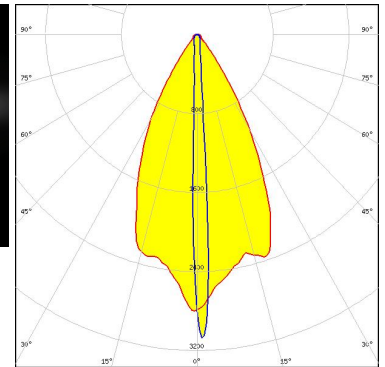

Light distribution files

SAMSUNG

LED LH351D
 FWHM / FWTM 5.0° / 9.0°
 Efficiency 54 %
 Peak intensity 29 cd/lm
 LEDs/each optic 1
 Light colour/type White
 Required components:

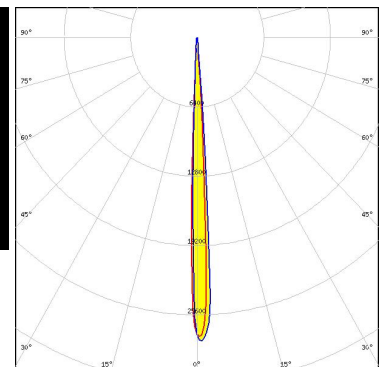

Light distribution files

OPTICAL RESULTS (MEASURED):

SAMSUNG

LED LH508A
FWHM / FWTM 7.0° / 11.0°
Efficiency 50 %
Peak intensity 17.3 cd/lm
LEDs/each optic 1
Light colour/type White
Required components:

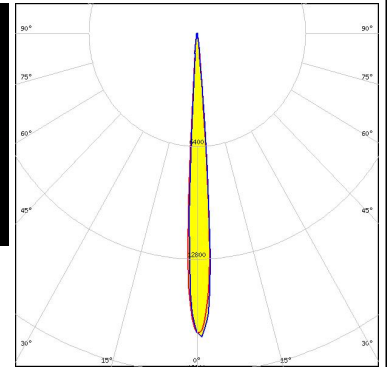
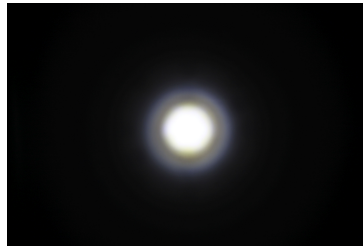

Light distribution files

SAMSUNG

LED LH508A
FWHM / FWTM 52.0 + 7.0° / 78.0 + 17.0°
Efficiency 45 %
Peak intensity 2.4 cd/lm
LEDs/each optic 1
Light colour/type White
Required components:
F16629_LEIA-SUB-O

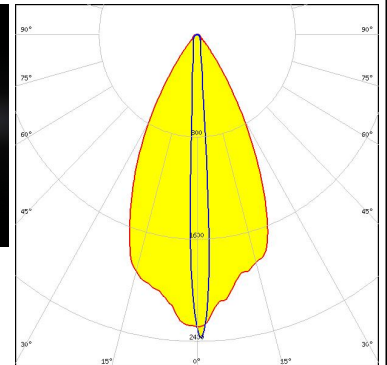

Light distribution files

OPTICAL RESULTS (SIMULATED):



LED XE-G
FWHM / FWTM 5.0° / 10.0°
Efficiency 47 %
Peak intensity 40.8 cd/lm
LEDs/each optic 1
Light colour/type White
Required components:

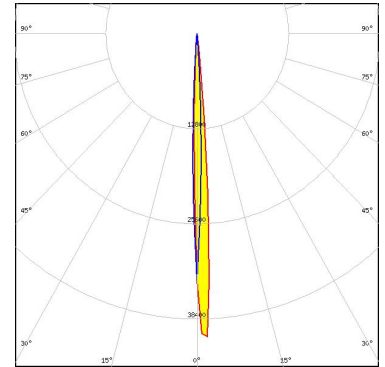

Light distribution files



LED XHP35 HI
FWHM / FWTM 3.6° / 8.5°
Efficiency 50 %
Peak intensity 44.8 cd/lm
LEDs/each optic 1
Light colour/type White
Required components:

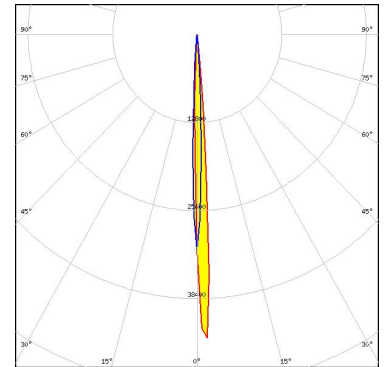

Light distribution files



LED XHP70.2
FWHM / FWTM 12.0° / 18.0°
Efficiency 48 %
Peak intensity 7.4 cd/lm
LEDs/each optic 1
Light colour/type White
Required components:

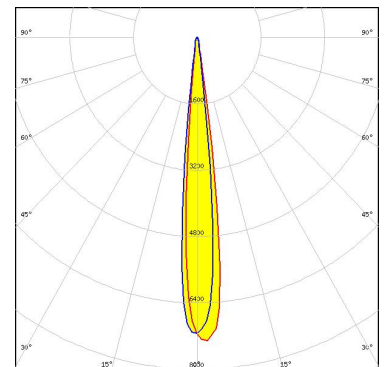

Light distribution files

OPTICAL RESULTS (SIMULATED):



LED XHP70.3 HD
 FWHM / FWTM 11.0° / 19.0°
 Efficiency 47 %
 Peak intensity 7.3 cd/lm
 LEDs/each optic 1
 Light colour/type White
 Required components:

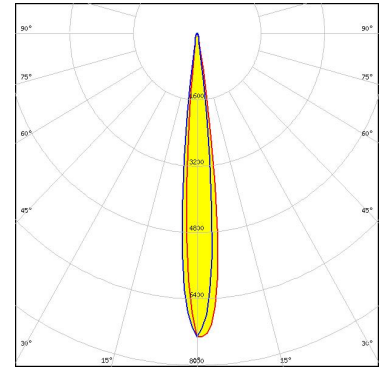

Light distribution files



LED XP-G2
 FWHM / FWTM 4.0° / 9.0°
 Efficiency 51 %
 Peak intensity 57 cd/lm
 LEDs/each optic 1
 Light colour/type White
 Required components:

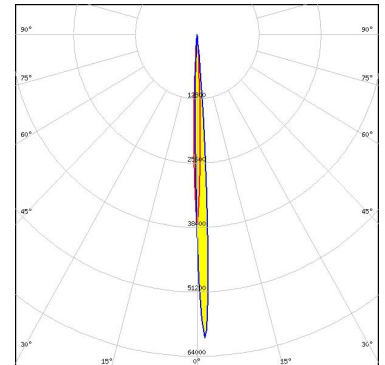

Light distribution files



LED XP-G2 HE
 FWHM / FWTM 36.0 + 5.0° / 58.0 + 12.0°
 Efficiency 44 %
 Peak intensity 4.3 cd/lm
 LEDs/each optic 1
 Light colour/type White
 Required components:
 F16629_LEIA-SUB-O

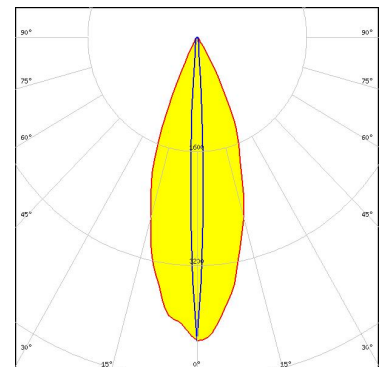

Light distribution files

OPTICAL RESULTS (SIMULATED):



LED XP-G2 HE
FWHM / FWTM 5.0° / 11.0°
Efficiency 48 %
Peak intensity 29.9 cd/m
LEDs/each optic 1
Light colour/type White
Required components:

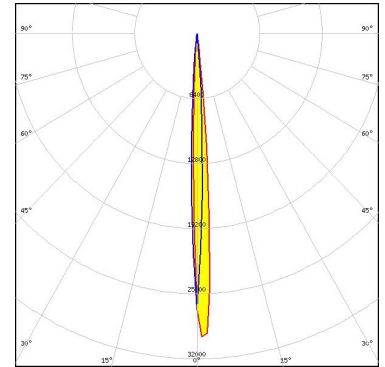

Light distribution files



LED XP-G3
FWHM / FWTM 5.8° / 11.9°
Efficiency 45 %
Peak intensity 24.6 cd/m
LEDs/each optic 1
Light colour/type White
Required components:

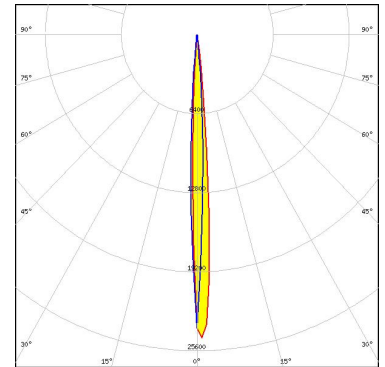

Light distribution files



LED XP-L HD
FWHM / FWTM 6.3° / 12.9°
Efficiency 51 %
Peak intensity 23.5 cd/m
LEDs/each optic 1
Light colour/type White
Required components:

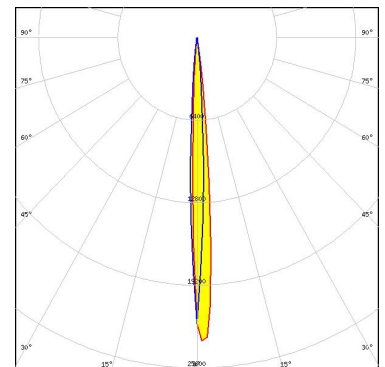

Light distribution files

OPTICAL RESULTS (SIMULATED):



LED XP-L HI
 FWHM / FWTM 4.5° / 9.5°
 Efficiency 53 %
 Peak intensity 42.6 cd/lm
 LEDs/each optic 1
 Light colour/type White
 Required components:

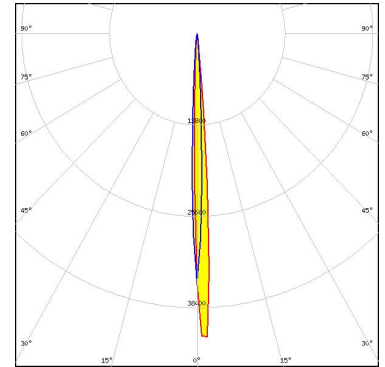

Light distribution files



LED LUXEON C
 FWHM / FWTM 3.6° / 7.0°
 Efficiency 36 %
 Peak intensity 53.7 cd/lm
 LEDs/each optic 1
 Light colour/type White
 Required components:

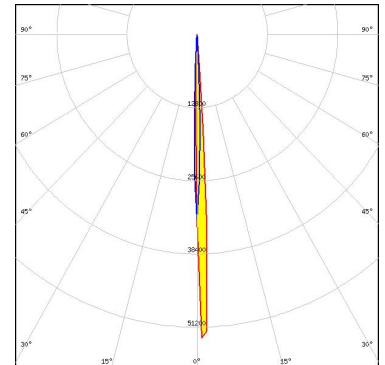

Light distribution files



LED LUXEON C
 FWHM / FWTM 27.0 + 4.0° / 54.0 + 10.0°
 Efficiency 35 %
 Peak intensity 4.4 cd/lm
 LEDs/each optic 1
 Light colour/type Red
 Required components:
 F16629_LEIA-SUB-O

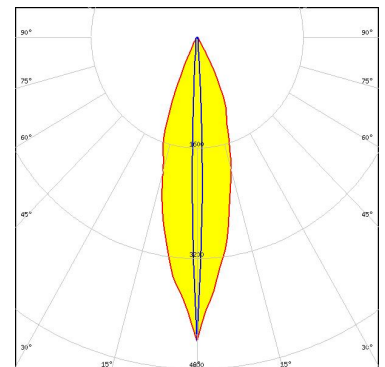

Light distribution files

OPTICAL RESULTS (SIMULATED):



LED LUXEON CZ
 FWHM / FWTM 10.0° / 16.0°
 Efficiency 42 %
 Peak intensity 11 cd/lm
 LEDs/each optic 4
 Light colour/type White
 Required components:

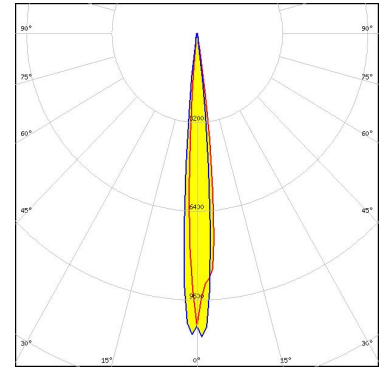

Light distribution files



LED LUXEON CZ
 FWHM / FWTM 28.0 + 4.0° / 54.0 + 10.0°
 Efficiency 47 %
 Peak intensity 6.3 cd/lm
 LEDs/each optic 1
 Light colour/type Red
 Required components:
 F16629_LEIA-SUB-O

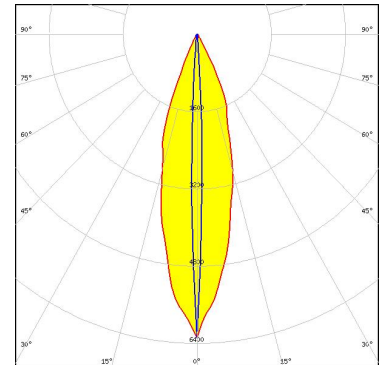

Light distribution files



LED LUXEON Rubix
 FWHM / FWTM 5.0° / 9.0°
 Efficiency 49 %
 Peak intensity 44.5 cd/lm
 LEDs/each optic 1
 Light colour/type Green
 Required components:

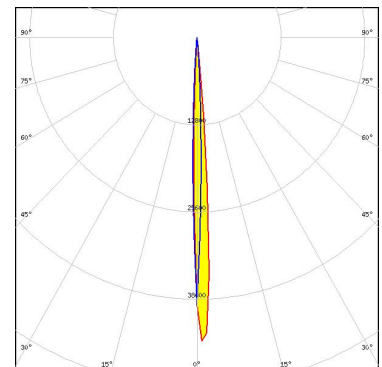

Light distribution files

OPTICAL RESULTS (SIMULATED):



LED LUXEON Rubix
 FWHM / FWTM 4.0° / 7.0°
 Efficiency 45 %
 Peak intensity 74.7 cd/m
 LEDs/each optic 1
 Light colour/type White
 Required components:

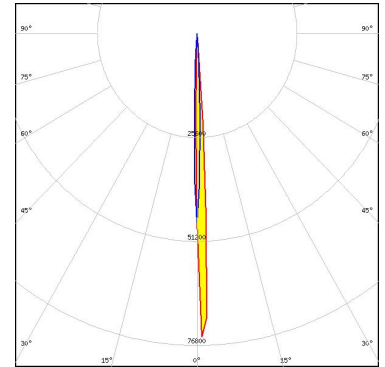

Light distribution files



LED LUXEON Rubix
 FWHM / FWTM 5.0° / 9.0°
 Efficiency 49 %
 Peak intensity 44.5 cd/m
 LEDs/each optic 1
 Light colour/type Blue
 Required components:

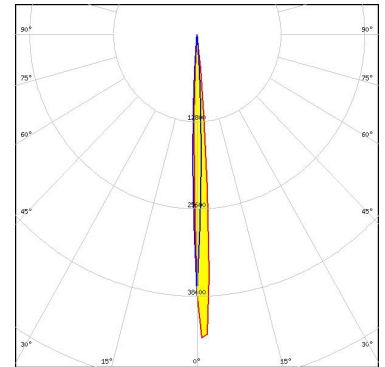

Light distribution files



LED LUXEON Rubix
 FWHM / FWTM 5.0° / 9.0°
 Efficiency 51 %
 Peak intensity 47.4 cd/m
 LEDs/each optic 1
 Light colour/type Red
 Required components:

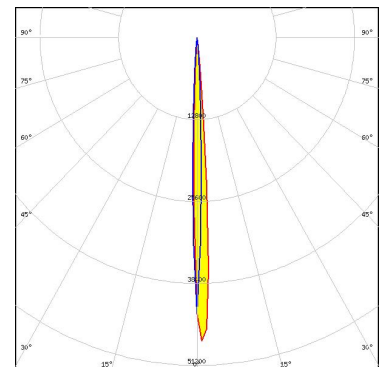

Light distribution files

OPTICAL RESULTS (SIMULATED):



LED LUXEON V2
 FWHM / FWTM 4.8° / 9.5°
 Efficiency 46 %
 Peak intensity 39.5 cd/lm
 LEDs/each optic 1
 Light colour/type White
 Required components:

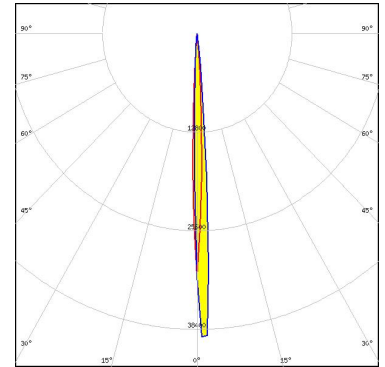

Light distribution files



LED SBT-90
 FWHM / FWTM 6.0° / 11.0°
 Efficiency 44 %
 Peak intensity 26 cd/lm
 LEDs/each optic 1
 Light colour/type White
 Required components:

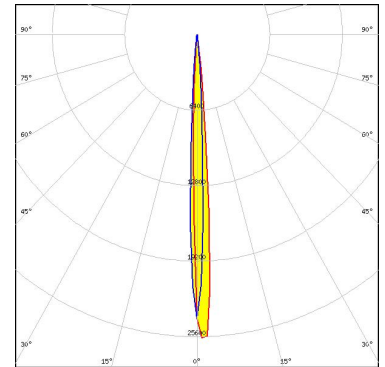

Light distribution files



LED SST-10-B130
 FWHM / FWTM 4.0° / 9.0°
 Efficiency 45 %
 LEDs/each optic 1
 Light colour/type IR
 Required components:

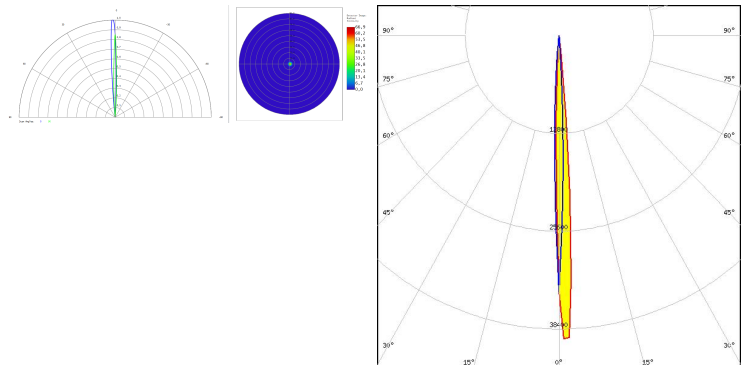

Light distribution files

OPTICAL RESULTS (SIMULATED):



LED NCSxE17A
 FWHM / FWTM 3.9° / 8.3°
 Efficiency 42 %
 Peak intensity 49.2 cd/lm
 LEDs/each optic 1
 Light colour/type White
 Required components:

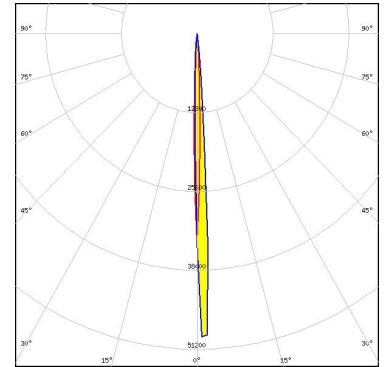

Light distribution files



LED NF2x757G
 FWHM / FWTM 4.6° / 9.2°
 Efficiency 50 %
 Peak intensity 52.2 cd/lm
 LEDs/each optic 1
 Light colour/type White
 Required components:

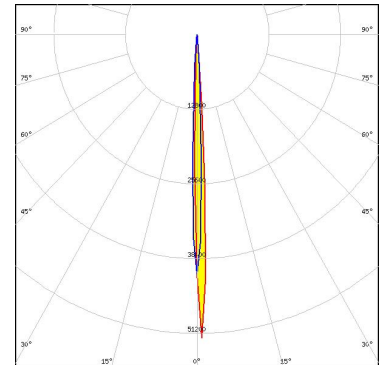

Light distribution files



LED NV4WB35AM
 FWHM / FWTM 7.0° / 13.0°
 Efficiency 46 %
 Peak intensity 21.9 cd/lm
 LEDs/each optic 1
 Light colour/type White
 Required components:

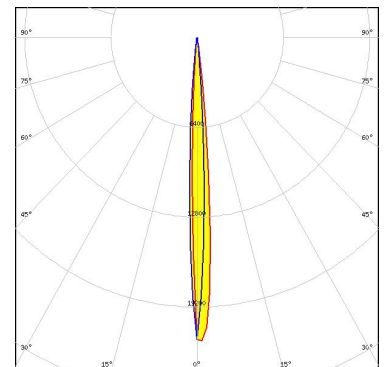

Light distribution files

OPTICAL RESULTS (SIMULATED):



LED NV4x144A
 FWHM / FWTM 9.0° / 15.0°
 Efficiency 44 %
 Peak intensity 12.6 cd/lm
 LEDs/each optic 1
 Light colour/type White
 Required components:

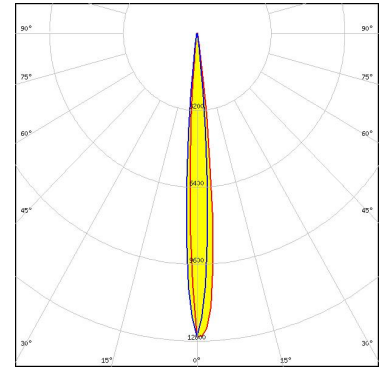

Light distribution files



LED NVSW3x9A
 FWHM / FWTM 2.4° / 4.8°
 Efficiency 44 %
 Peak intensity 34.5 cd/lm
 LEDs/each optic 1
 Light colour/type White
 Required components:

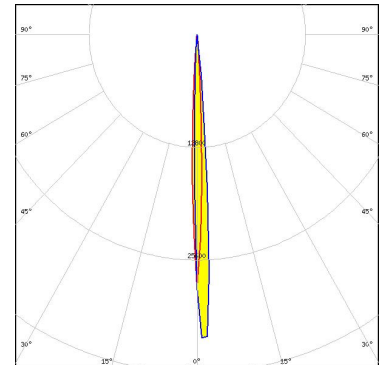

Light distribution files



LED NVSW519A
 FWHM / FWTM 5.0° / 10.0°
 Efficiency 45 %
 Peak intensity 28.4 cd/lm
 LEDs/each optic 1
 Light colour/type White
 Required components:

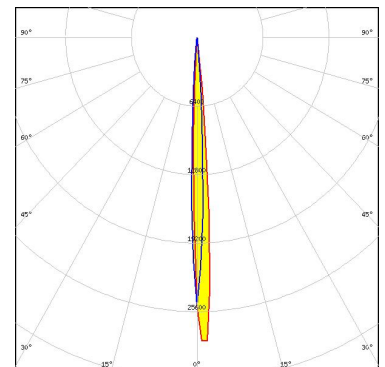

Light distribution files

OPTICAL RESULTS (SIMULATED):



LED NVSxE21A
 FWHM / FWTM 2.2° / 4.3°
 Efficiency 44 %
 Peak intensity 34.5 cd/lm
 LEDs/each optic 1
 Light colour/type White
 Required components:

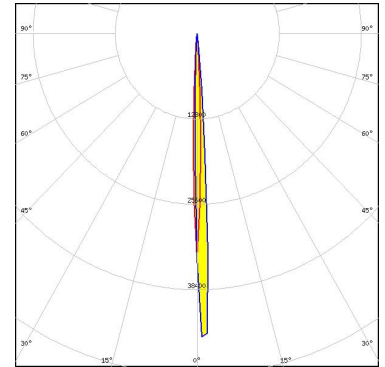

Light distribution files



LED OSCONIQ P 3737 (3W) PUSTA1
 FWHM / FWTM 5.0° / 11.0°
 Efficiency 47 %
 Peak intensity 31.8 cd/lm
 LEDs/each optic 1
 Light colour/type White
 Required components:

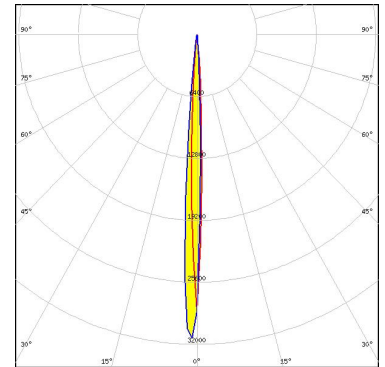

Light distribution files



LED OSLOM Black Flat (LUW HWQP)
 FWHM / FWTM 4.5° / 11.0°
 Efficiency 50 %
 Peak intensity 40.4 cd/lm
 LEDs/each optic 1
 Light colour/type White
 Required components:

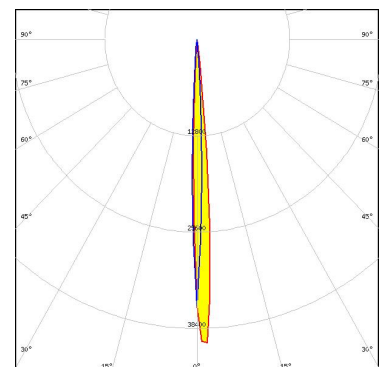

Light distribution files

OPTICAL RESULTS (SIMULATED):

OSRAM
Opto Semiconductors

LED OSLON Pure 1414
 FWHM / FWTM 5.0 + 4.0° / 9.0 + 10.0°
 Efficiency 52 %
 Peak intensity 46.4 cd/lm
 LEDs/each optic 1
 Light colour/type White
 Required components:

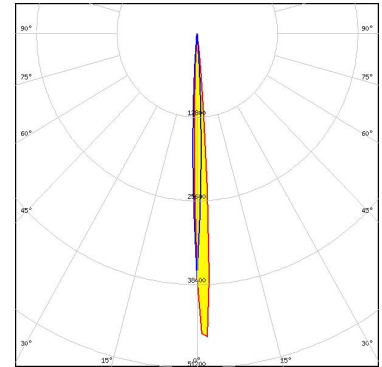

Light distribution files

OSRAM
Opto Semiconductors

LED OSLON Square CSSRM2/CSSRM3
 FWHM / FWTM 4.0° / 9.0°
 Efficiency 47 %
 Peak intensity 55 cd/lm
 LEDs/each optic 1
 Light colour/type White
 Required components:

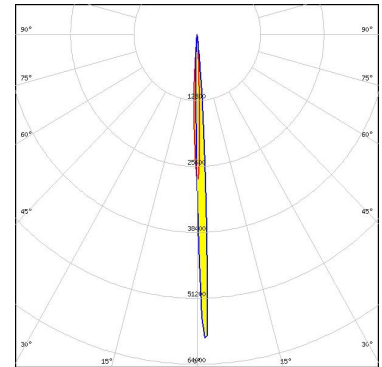

Light distribution files

OSRAM
Opto Semiconductors

LED OSLON Square EC
 FWHM / FWTM 4.0° / 8.0°
 Efficiency 57 %
 Peak intensity 68 cd/lm
 LEDs/each optic 1
 Light colour/type White
 Required components:

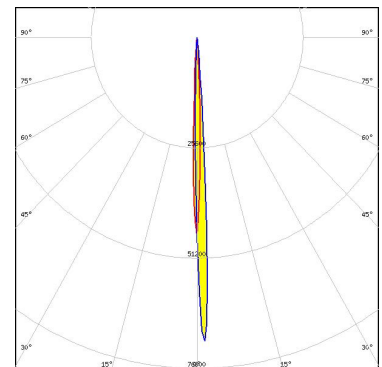

Light distribution files

OPTICAL RESULTS (SIMULATED):

OSRAM
Opto Semiconductors

LED OSLON SSL 150
 FWHM / FWTM 5.0° / 10.0°
 Efficiency 41 %
 Peak intensity 31.6 cd/lm
 LEDs/each optic 1
 Light colour/type Red
 Required components:

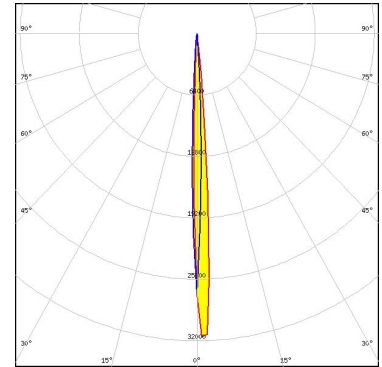

Light distribution files

OSRAM
Opto Semiconductors

LED OSTAR Projection Compact (KW.CSLNM1.TG)
 FWHM / FWTM 5.0° / 11.0°
 Efficiency 74 %
 Peak intensity 46.1 cd/lm
 LEDs/each optic 1
 Light colour/type White
 Required components:

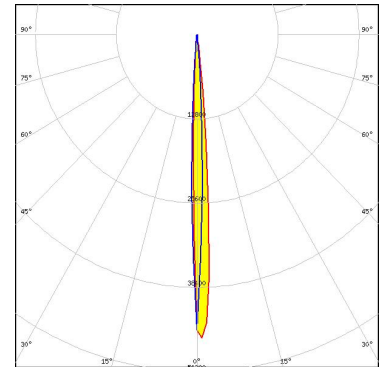

Light distribution files

OSRAM
Opto Semiconductors

LED OSTAR Stage (S2WM)
 FWHM / FWTM 6.0° / 11.0°
 Efficiency 49 %
 Peak intensity 35.2 cd/lm
 LEDs/each optic 1
 Light colour/type White
 Required components:

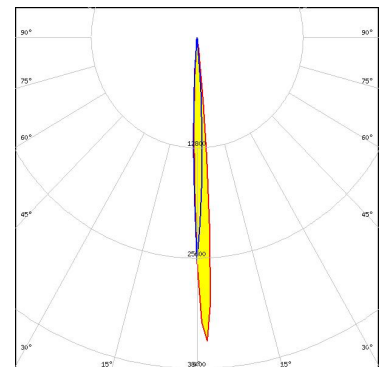

Light distribution files

OPTICAL RESULTS (SIMULATED):

OSRAM
Opto Semiconductors

LED OSTAR Stage (S2WM)
 FWHM / FWTM 32.0 + 4.0° / 56.0 + 12.0°
 Efficiency 47 %
 Peak intensity 4.9 cd/lm
 LEDs/each optic 1
 Light colour/type White
 Required components:
 F16629_LEIA-SUB-O

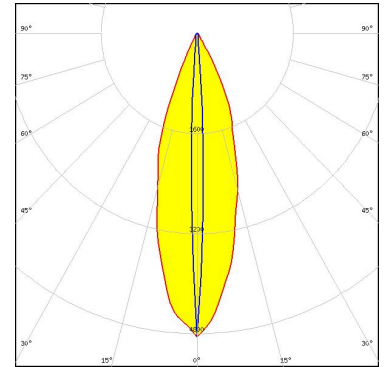

Light distribution files

OSRAM
Opto Semiconductors

LED OSTAR Stage (S2WN)
 FWHM / FWTM 5.0° / 9.0°
 Efficiency 47 %
 Peak intensity 47.3 cd/lm
 LEDs/each optic 1
 Light colour/type RGBW
 Required components:

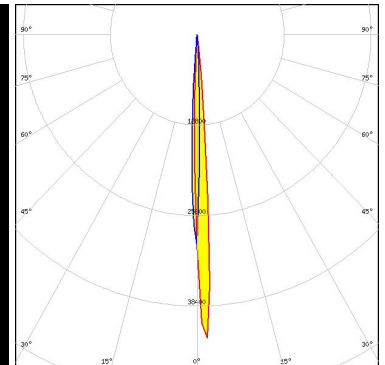
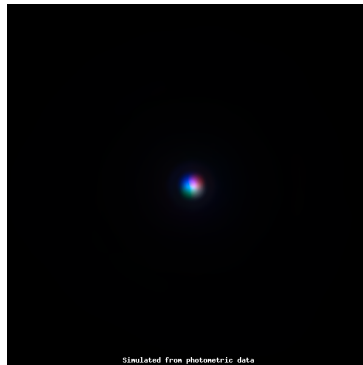

Light distribution files

OSRAM
Opto Semiconductors

LED SFH 4715AS
 FWHM / FWTM 29.0 + 4.0° / 56.0 + 12.0°
 Efficiency 53 %
 Peak intensity 6.1 cd/lm
 LEDs/each optic 1
 Light colour/type White
 Required components:
 F16629_LEIA-SUB-O

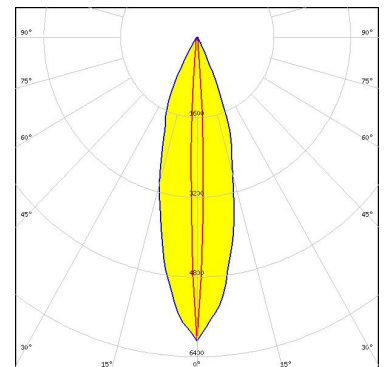

Light distribution files

OPTICAL RESULTS (SIMULATED):

OSRAM
Opto Semiconductors

LED SFH 4715AS
FWHM / FWTM 4.0° / 9.0°
Efficiency 47 %
LEDs/each optic 1
Light colour/type IR
Required components:

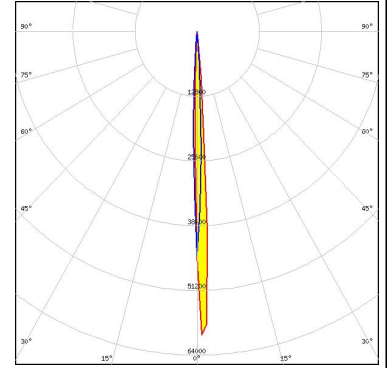

Light distribution files

OSRAM
Opto Semiconductors

LED SFH 4716AS
FWHM / FWTM 5.0° / 9.0°
Efficiency 36 %
LEDs/each optic 1
Light colour/type IR
Required components:

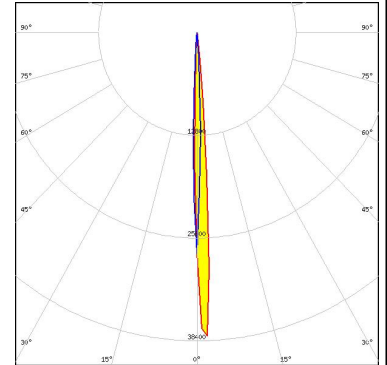

Light distribution files

GENERAL INFORMATION:

NOTE: The typical beam angle will be changed by different color, chip size and chip position tolerance. The typical total beam angle is the full angle measured where the luminous intensity is half of the peak value.

MATERIALS:

As part of our continuous research and improvement processes, and to ensure the best possible quality and availability of our products, LEDiL reserves the right to change material grades without notice.

PRODUCT DATA USER AGREEMENT AND DISCLAIMER:

The measured data in the provided downloadable LEDiL Product Datasheets and Mechanical 2D-Drawings is rounded and provided as reference for planning. LEDiL Oy's optical specifications have been verified by conducting performance testing of the products in accordance with the company's quality system. The reported data are averaged results of multiple measurements with typical variation. LEDiL Oy reserves the right to without prior notification make changes and improvements to its products.

LEDiL Oy assumes neither warranty, nor guarantee nor any other liability of any kind for the contents and correctness of the provided data. The provided data has been generated with highest diligence but the provided data may in reality not represent the complete possible variation range of all intrinsic parameters. Therefore, in certain cases a deviation from the provided data could occur.

LEDiL Oy reserves the right to undertake technical changes of its products without further notification which could lead to changes in the provided data. LEDiL Oy assumes no liability of any kind for the possible deviation from any provided data or any other damage resulting from the usage of the provided data.

The user agrees to this disclaimer and user agreement with the download or usage of the provided files.

LEDiL Oy

Joensuunkatu 7
FI-24100 SALO
Finland

LEDiL Inc.

228 West Page Street
Suite D
Sycamore IL 60178
USA

Ledil Optics Technology (Shenzhen) Co., Ltd.

405 , Block B
Casic Motor Building
Shenzhen 518057
P.R.CHINA

Local sales and technical support

[www.ledil.com/
where_to_buy](http://www.ledil.com/where_to_buy)

Shipping locations

Poznan, Poland
Hong Kong, China

Distribution Partners

[www.ledil.com/
where_to_buy](http://www.ledil.com/where_to_buy)