

DRAFT A

SYM	ECN	DESCRIPTION	DATE	APPROVED
0A	---	FIRST RELEASE	10/26'23	Dam

- NOTES:
- MATERIAL SEE TABLE A
 - GENERAL SPECIFICATION:
 - CURRENT RATING: 5A.
 - CONTACT RESISTANCE: 40mΩ MAX (INITIAL).
 - INSULATOR RESISTANCE: 100MΩ MIN.
 - DIELECTRIC WITHSTANDING VOLTAGE: 100 VAC
 - OPERATION TEMPERATURE: -40°C~+105°C
 - DIMENSION AND TOLERANCE PER ASME Y14.5M-1994.
 - TYPE-C SPECIFICATION COMPLIANCE TO USB TYPE-C CONNECTOR COMPLIANCE DOCUMENT.
 - ORDER P/N SYSTEM: USBCBRX0101SR

CODE OPTION
 A:CODE A
 B:CODE B

 Z:CODE Z

PACKAGE
 R:TAPE REEL

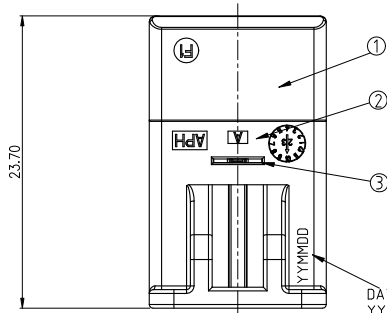

DATE CODE:
 YY:YEAR
 MM:MONTH
 DD:DAY

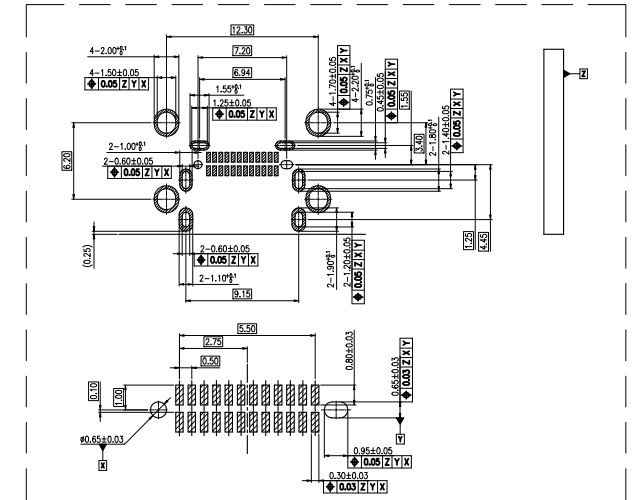
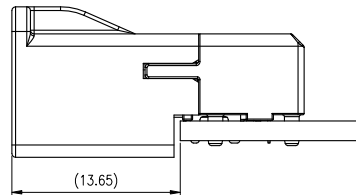
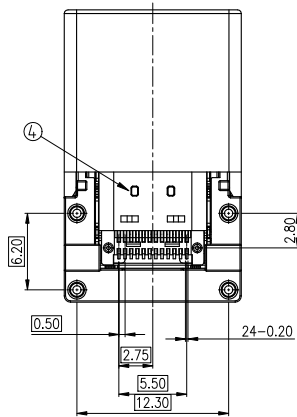
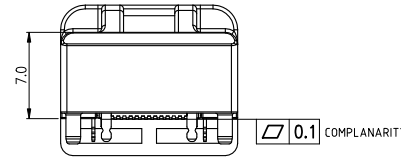
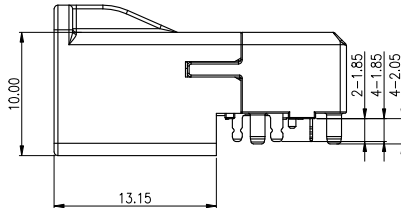
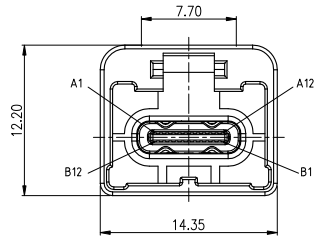
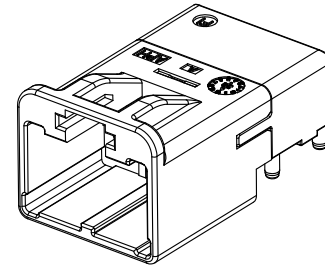

PIN DEFINITION:

PIN NO.	A1	A2	A3	A4	A5	A6	A7	A8	A9	A10	A11	A12
SIGNAL	GND	TX1+	TX1-	VBUS	CC1	D+	D-	SBU1	VBUS	RX2-	RX2+	GND
PIN NO.	B12	B11	B10	B9	B8	B7	B6	B5	B4	B3	B2	B1

TABLE A (BOM)

4	USBC	CONTACT MATING AREA: AU PLATE OVER NICKEL CONTACT SOLDER AREA: GOLD FLASH OVER NICKEL SHELL SOLDER AREA: SOLDERING NICKEL	1
3	HOUSING	PAL7 30%GF, X=CODE OPTION (A,B,C,D,E,F,Z),UL94 V0	1
2	BAFFLE	SUS304, T=0.3mm, 1/2H	1
1	DIECAST	ZINC ALLOY 3#, TIN PLATED	1
ITEM	COMPONENTS	MATERIAL	QTY

CODING DEFINITION

CODE	A	B	C	D	E	F	Z
COLOR	BLACK	WHITE	BLUE	CLARET VIOLET	MAY GREEN	NUT BROWN	WATER BLUE



HF(无卤)	√
Non-HF(有卤)	

APPROVAL DATE: 10/26'23

Amphenol
 Amphenol East Asia Limited

TITLE: MINI HSBRIDGE+ RA BOARD CONNECTOR

SIZE: A3
 DRAWING NO.: USBCBRX0101SR
 REV.: 0A

SCALE: N/A
 SHEET 1 OF 1