

Click to
ORDER
samples

AMSRB1-78LPZ



SIP3 Package

The AMSRB1-78LPZ series are SIP3 DC/DC high efficiency switching regulators and ideal substitutes for LM78xx series three-terminal linear regulators. The switching regulators feature high efficiency, low loss, short circuit protection, and there is no need for a heat sink.

It also features excellent reliability and performance while offering a wide input voltage range of 6-36VDC as well as an output voltage of -15~15V. This compact SIP3 design will surely benefit your new system design.

This new series offers great operating temperatures, from -40 to 85°C with full power up to 71°C. Additionally, 2,000,000 hours MTBF comes standard.

The AMSRB1-78LPZ is suitable for instrumentation, industrial control and electric power.

Features

- Pin-out compatible with LM78XX Linear
- Non isolated, heatsinks not required
- Efficiency up to 96%
- Operating Temp: -40 °C to +85 °C
- Short circuit protection: Continuous, Auto recovery
- Low Quiescent Current
- Negative output available

Summary

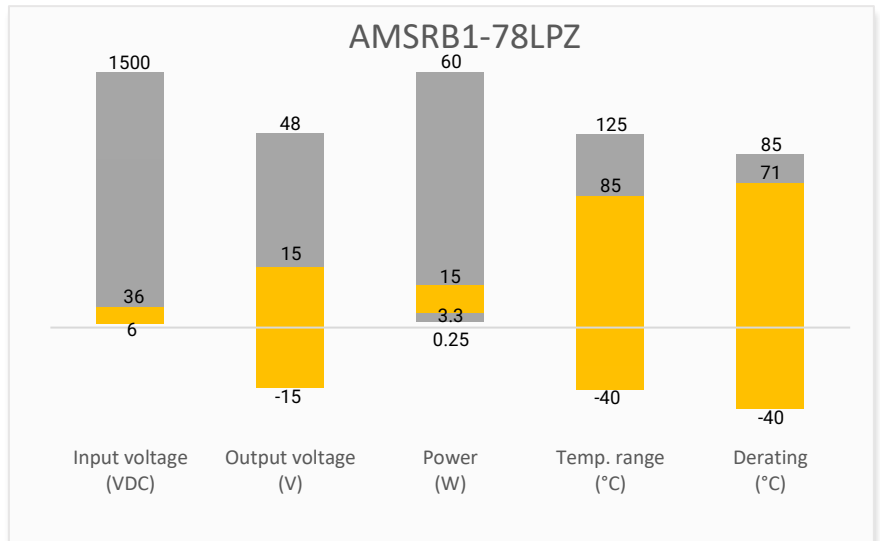

Training



Product Training Video
(click to open)



Press Release

Coming Soon!

Application Notes

Applications



IoT



Industrial



Telecom



Portable Equipment

Models & Specifications



Model	Input Voltage (VDC)	Output Voltage (VDC)	Output Current max (mA)	Maximum capacitive Load (μF)	Efficiency Vin Min (%)	Efficiency Vin Max (%)
AMSRB1-783.3LPZ	6-36	3.3	1000	680	90	80
AMSRB1-7805LPZ	8-36	5	1000	680	93	85
	8-27	-5	-500	330	85	81
AMSRB1-7806LPZ	10-36	6.5	1000	680	93	85
AMSRB1-7809LPZ	13-36	9	1000	680	94	89
AMSRB1-7812LPZ	16-36	12	1000	680	95	92
	8-20	-12	-300	330	88	87
AMSRB1-7815LPZ	20-36	15	1000	680	96	93
	8-18	-15	-300	330	87	88

Input Specification

Parameters	Conditions	Typical	Maximum	Units
Voltage range	See Models table above			
Quiescent Current	Positive output	0.3	1	mA
	Negative output	1	4	mA
Reverse Polarity Input	Prohibited			
Filter	Capacitor			

Output Specification

Parameters	Conditions	Typical	Maximum	Units
Voltage accuracy	100% load, 3.3Vout	±2	±4	%
	100% load, others	±1.5	±3	%
Dynamic load stability	Nominal input voltage, 25% load step change	±60	±200	mV
Transient recovery time	Nominal input voltage, 25% load step change	0.2	1	ms
Line regulation	100% load	±0.2	±0.4	%
Load regulation	Nominal input, 10-100% load, Positive output	±0.4	±0.6	%
	Nominal input, 10-100% load, Negative output	±0.4	±0.8	%
Temperature coefficient	Full load, -40°C to 85°C		±0.03	%/°C
Ripple & Noise	20MHz Bandwidth	25	75	mV pk-pk

General Specifications

Parameters	Conditions	Typical	Maximum	Units
Switching frequency	Full load	600		KHz
Short circuit protection	Continuous, auto recovery			
Operating temperature	With derating at 71°C	-40 to +85		°C
Storage temperature		-55 to +125		°C
Cooling	Free air convection			
Humidity	Non-condensing		95	% RH
Case material	Black plastic (UL94-V0)			
Weight		1.8		g
Dimensions (L x W x H)		0.46 x 0.30 x 0.40 inches (11.60 x 7.55 x 10.16 mm)		
MTBF	> 2 000 000 hrs (MIL-HDBK -217F, t _v =+25°C) / Full Load			

Maximum Soldering Temperature	Welding time: 10s (Max.), 1.5mm away from case	260	°C
-------------------------------	--	-----	----

NOTE: All specifications in this datasheet are measured at an ambient temperature of 25°C, humidity<75%, nominal input voltage and at rated output load unless otherwise specified.

Safety Specifications

Parameters

Standards	Designed to meet UL/EN/IEC62368-1	
	EMC - Conducted and radiated emission	CISPR32 / EN55032, class B with the recommended EMI circuit
	Electrostatic Discharge Immunity	IEC/EN 61000-4-2
	RF, Electromagnetic Field Immunity	IEC/EN 61000-4-3
	Electrical Fast Transient/Burst Immunity	IEC/EN 61000-4-4
	RF, Conducted Disturbance Immunity	IEC/EN 61000-4-6

Derating

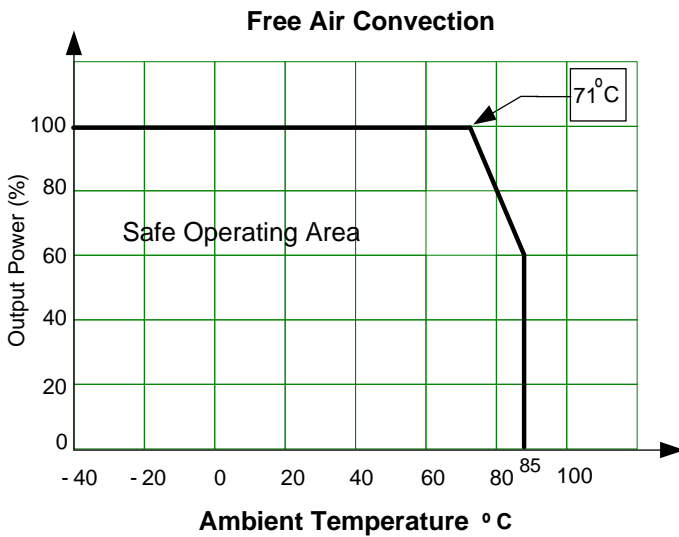

Typical application circuit

Positive Output Typical Application Circuit

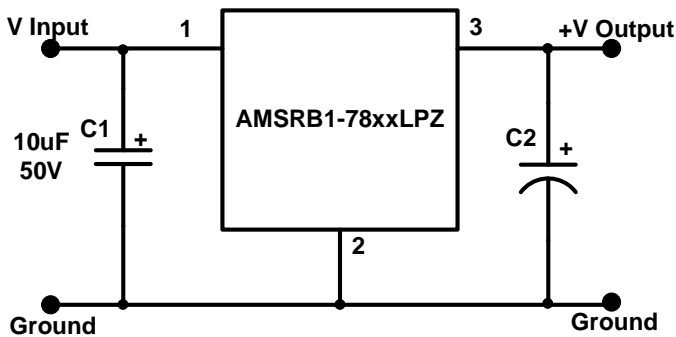

Negative Output Typical Application Circuit

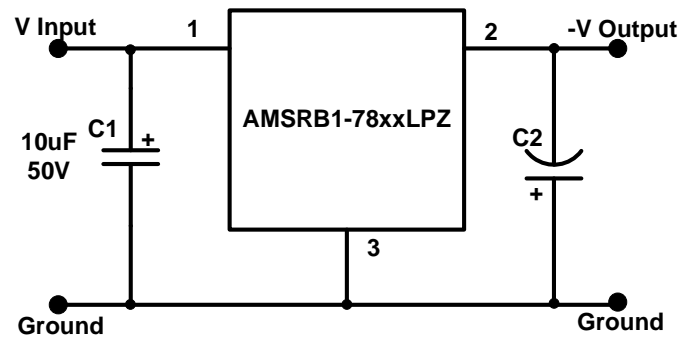

Positive and Negative dual output application circuit

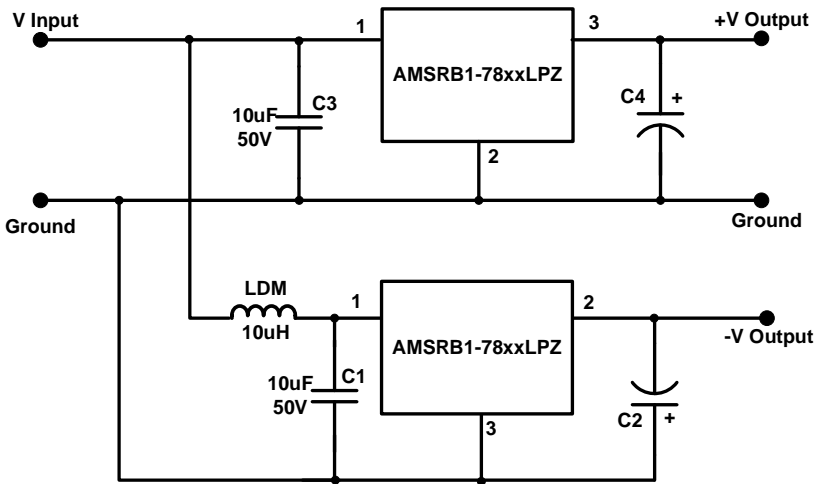

Model	C2/C4(μF)
3.3/5V output	22μF / 10V
6.5/9V output	22μF / 16V
12/15V output	22μF / 25V

Notes:

- 1- It is recommended that tantalum capacitor and aluminum electrolytic capacitor of low ESR capacitors are used for C2. C1/C3 & C2/C4 are required and should be installed as close to the converter as possible.
- 2- The converter can be used both for positive and negative output using the circuit connection shown above.
- 3- The converter cannot be used in parallel to enlarge the power for the output and hot swap.

EMI Recommended circuit

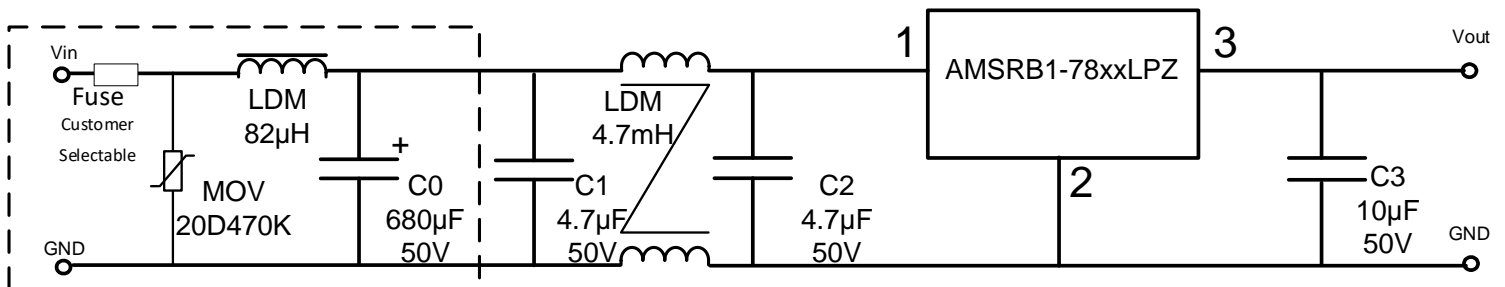

Dimensions

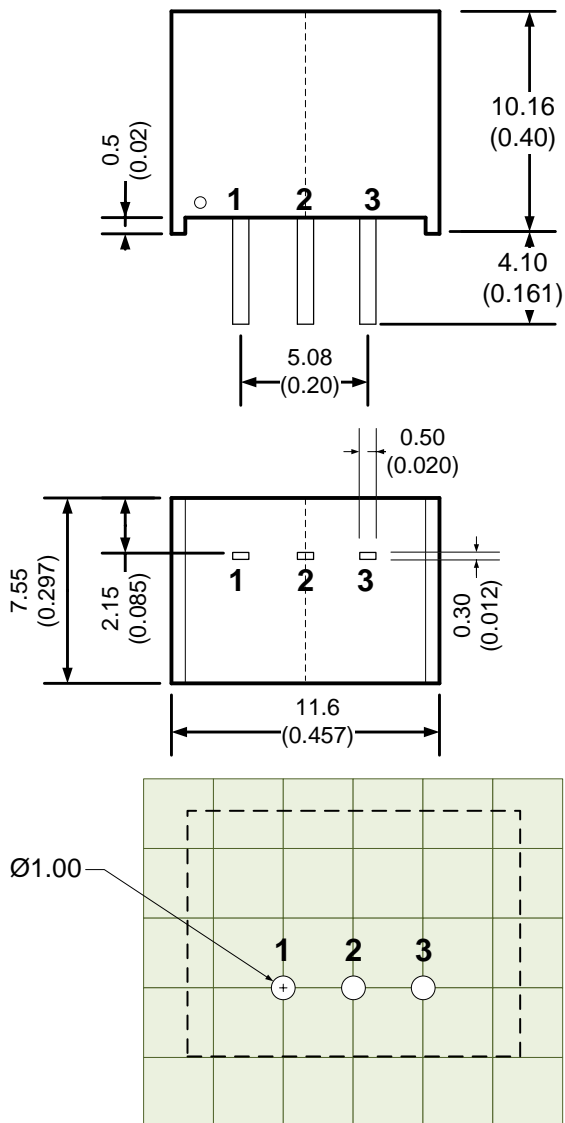

Grid: 2.54 x 2.54mm
Unit:mm[inch]
General tolerances:±0.5mm [± 0.020inch]

Pin Out Specifications		
Pin	Positive output	Negative output
1	+V Input	+V Input
2	Ground	-V Output
3	+V Output	Ground

NOTE: **1.** Datasheets are updated as needed and as such, specifications are subject to change without notice. Once printed or downloaded, datasheets are no longer controlled by Aimtec; refer to www.aimtec.com for the most current product specifications. **2.** Product label shown, including safety agency certifications on label, may vary based on the date manufactured. **3.** Mechanical drawings and specifications are for reference only. **4.** All specifications are measured at an ambient temperature of 25°C, humidity<75%, nominal input voltage and at rated output load unless otherwise specified. **5.** Aimtec may not have conducted destructive testing or chemical analysis on all internal components and chemical at the time of publishing this document. CAS numbers and other limited information are considered proprietary and may not be available for release. **6.** This product is not designed for use in critical life support systems, equipment used in hazardous environments, nuclear control systems or other such applications which necessitate specific safety and regulatory standards other the ones listed in this datasheet. **7.** Warranty is in accordance with Aimtec's standard Terms of Sale available at www.aimtec.com.