

## Data Sheet | Item Number: 2000-1202

2-conductor through terminal block; 1 mm<sup>2</sup>; suitable for Ex e II applications; side and center marking; for DIN-rail 35 x 15 and 35 x 7.5; Push-in CAGE CLAMP®; 1,00 mm<sup>2</sup>; orange

<https://www.wago.com/2000-1202>

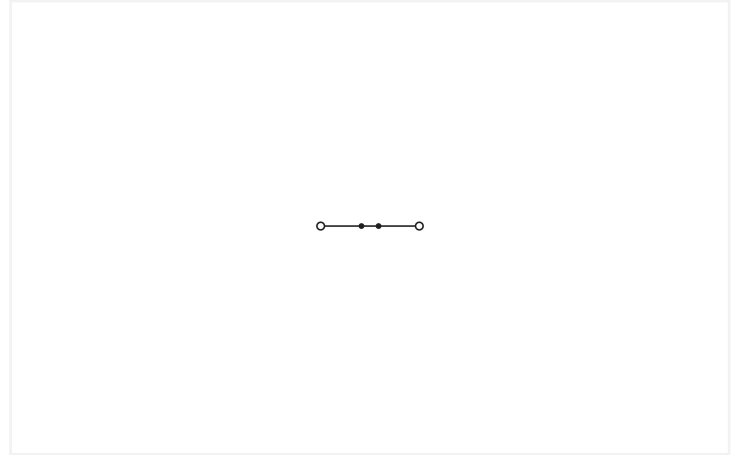
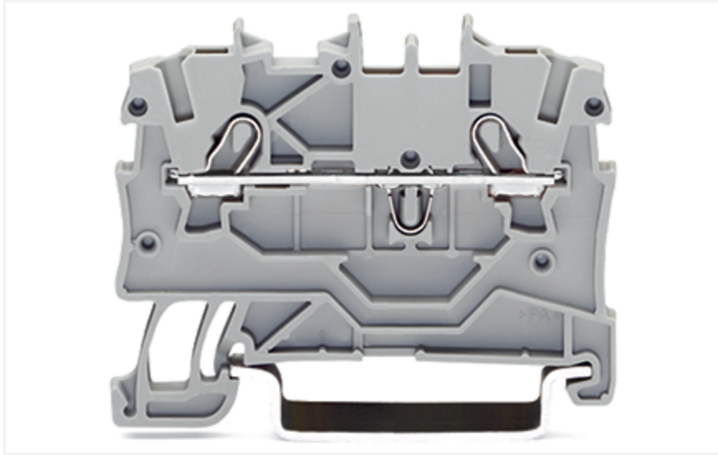

Color: ■ orange

Similar to illustration

Similar to illustration

### Through terminal block, 2000 Series, Push-in CAGE CLAMP®

Our through terminal block (item number 2000-1202) ensures effortless electrical installations. Strip lengths must be between 9 and 11 mm when connecting conductors to this through terminal block. Whether in industrial or building applications, our rail-mount through terminal blocks are the perfect solution to quickly and securely connect electrical conductors. Depending on the variant, you can use them for either typical through-wiring or potential distribution. This product features conductor terminals and utilizes Push-in CAGE CLAMP®. Push-in CAGE CLAMP® connection technology is ideal for connecting all conductor types. Solid and fine-stranded conductors with ferrules can be plugged in without needing to use any tools—all thanks to its pluggable design. The item's dimensions are (3.5 x 48.5 x 39.5) mm (width x height x depth). Depending on the conductor type, this through terminal block is designed for conductor cross sections ranging from 0.14 mm<sup>2</sup> to 1.5 mm<sup>2</sup>.

An operating tool is used to operate this through rail-mount terminal block. Our TOPJOB® S rail-mount terminal blocks are perfect for a wide range of industrial applications and modern building installations as they provide secure electrical connections. You can work anywhere in the world and on any application with just a single rail-mount terminal block system. This product is designed for specific Ex applications (please refer to the product datasheet).

| Electrical data   |                  |     |    |               |         |       |   |
|---|------------------|-----|----|---------------|---------|-------|---|
| Ratings per   | IEC/EN 60947-7-1 |     |    | Approvals per | UL 1059 |       |   |
| Overvoltage category                                      | III              | III | II | Use group     | B       | C     | D |
| Pollution degree  | 3                | 2   | 2  | Rated voltage | 600 V   | 600 V | - |
| Nominal voltage   | 800 V            | -   | -  | Rated current | 15 A    | 15 A  | - |
| Rated impulse withstand voltage                           | 8 kV             | -   | -  |               |         |       |   |
| Rated current   | 13.5 A           | -   | -  |               |         |       |   |
| Current at conductor cross-section (max.) mm <sup>2</sup> | 17.5 A           | -   | -  |               |         |       |   |

| Approvals per | CSA 22.2 No 158 |       |   |
|---------------|-----------------|-------|---|
|               | B               | C     | D |
| Use group     | B               | C     | D |
| Rated voltage | 600 V           | 600 V | - |
| Rated current | 10 A            | 10 A  | - |

| Ex information                      |   |
|-------------------------------------|---|
| Reference to hazardous areas        | See application instructions in section "Knowledge and Downloads – Documentation – Additional Information: Technical Section; Technical Explications" |
| Ratings per                         | ATEX: PTB 11 ATEX 1041 U / IECEx: PTB 11.0093U (Ex eb IIC Gb)   |
| Rated voltage EN (Ex e II)          | 550 V   |
| Rated current (Ex e II)             | 13 A  |
| Rated current (Ex e II) with jumper | 12 A  |

| Power Loss   |                  |
|--|------------------|
| Power loss, per pole (potential)                             | 0.4338 W         |
| Rated current $I_N$ for power loss specification             | 13.5 A           |
| Resistance value for specified, current-dependent power loss | 0.00238 $\Omega$ |

| General information |                    |
|---------------------|--------------------|
| Wiring direction    | Front-entry wiring |

| Connection Data            |   |
|----------------------------|---|
| Clamping units             | 2 |
| Total number of potentials | 1 |
| Number of levels           | 1 |
| Number of jumper slots     | 2 |

| Connection 1   |   |
|--|---|
| Connection technology                                      | Push-in CAGE CLAMP®   |
| Actuation type   | Operating tool  |
| Connectable conductor materials                            | Copper  |
| Nominal cross-section                                      | 1 mm <sup>2</sup>   |
| Solid conductor  | 0.14 ... 1.5 mm <sup>2</sup> / 24 ... 16 AWG  |
| Solid conductor; push-in termination                       | 0.5 ... 1.5 mm <sup>2</sup> / 20 ... 16 AWG   |
| Fine-stranded conductor                                    | 0.14 ... 1.5 mm <sup>2</sup> / 24 ... 16 AWG  |
| Fine-stranded conductor; with insulated ferrule            | 0.14 ... 0.75 mm <sup>2</sup> / 24 ... 18 AWG   |
| Fine-stranded conductor; with ferrule; push-in termination | 0.5 ... 0.75 mm <sup>2</sup> / 20 ... 18 AWG  |
| Note (conductor cross-section)                             | Depending on the conductor characteristic, a conductor with a smaller cross-section can also be inserted via push-in termination. |
| Strip length   | 9 ... 11 mm / 0.35 ... 0.43 inches  |
| Wiring direction   | Front-entry wiring  |

| Physical data                     |                        |
|-----------------------------------|------------------------|
| Width                             | 3.5 mm / 0.138 inches  |
| Height                            | 48.5 mm / 1.909 inches |
| Depth from upper-edge of DIN-rail | 32.9 mm / 1.295 inches |
| Depth                             | 39.5 mm / 1.555 inches |

| Mechanical data |                     |
|-----------------|---------------------|
| Mounting type   | DIN-35 rail         |
| Marking level   | Center/side marking |

## Material data

|                                    |  |
|------------------------------------|--|
| Note (material data)               | <a href="#">Information on material specifications can be found here</a> |
| Color                              | orange   |
| Material group                     | I  |
| Insulation material (main housing) | Polyamide (PA66)   |
| Flammability class per UL94        | V0   |
| Fire load                          | 0.08 MJ  |
| Weight                             | 3.6 g  |

## Environmental requirements

|   |  |   |
|---|--|---|
| Processing temperature  | -35 ... +85 °C   | <b>Environmental Testing</b>                        |
| Continuous operating temperature  | -60 ... +105 °C  |   |
| Test specification:   | Railway applications –<br>Rolling stock –<br>Electronic equipment                | DIN EN 50155 (VDE 0115-200):2022-06                 |
| Test procedure:   | Railway applications –<br>Rolling stock equipment –<br>Vibration and shock tests | DIN EN 61373 (VDE 0115-0106):2011-04                |
| Spectrum/Mounting location  |  | Service life test, Category 1, Class A/B            |
| Functional test with noise-like oscillations                                    |  | Test passed according to Section 8 of the standard  |
| Frequency   |  | $f_1 = 5 \text{ Hz}$ to $f_2 = 150 \text{ Hz}$      |
| Acceleration  |  | 0.101g (highest test level used for all axes)       |
| Test duration per axis  |  | 10 min.   |
| Test directions   |  | X, Y and Z axes                                     |
| Monitoring of contact faults and interruptions                                  |  | Passed  |
| Voltage drop measurement before and after each axis                             |  | Passed  |
| Simulated service life test through increased levels of noise-like oscillations |  | Test passed according to Section 9 of the standard  |
| Frequency   |  | $f_1 = 5 \text{ Hz}$ to $f_2 = 150 \text{ Hz}$      |
| Acceleration  |  | 0.572g (highest test level used for all axes)       |
| Test duration per axis  |  | 5 h   |
| Test directions   |  | X, Y and Z axes                                     |
| Extended testing: Monitoring of contact faults and interruptions                |  | Passed  |
| Extended testing: Voltage drop measurement before and after each axis           |  | Passed  |
| Shock test  |  | Test passed according to Section 10 of the standard |
| Shock pulse form  |  | Half sine   |
| Acceleration  |  | 5g (highest test level used for all axes)           |
| Shock duration  |  | 30 ms   |
| Number of shocks (per axis)   |  | 3 pos. und 3 neg.                                   |
| Test directions   |  | X, Y and Z axes                                     |
| Extended testing: Monitoring of contact faults and interruptions                |  | Passed  |
| Extended testing: Voltage drop measurement before and after each axis           |  | Passed  |
| Vibration and shock stress for rolling stock equipment                          |  | Passed  |

### Commercial data

|                       |               |
|-----------------------|---------------|
| Product Group         | 22 (TOPJOB S) |
| PU (SPU)              | 100 pcs       |
| Packaging type        | Box           |
| Country of origin     | CN            |
| GTIN                  | 4045454966775 |
| Customs tariff number | 85369010000   |

### Product Classification

|             |                      |
|-------------|----------------------|
| UNSPSC      | 39121410             |
| eCl@ss 10.0 | 27-14-11-20          |
| eCl@ss 9.0  | 27-14-11-20          |
| ETIM 9.0    | EC000897             |
| ETIM 10.0   | EC000897             |
| ECCN        | NO US CLASSIFICATION |

### Environmental Product Compliance

|                        |                         |
|------------------------|-------------------------|
| RoHS Compliance Status | Compliant, No Exemption |
|------------------------|-------------------------|

### Approvals / Certificates

#### General approvals



| Approval                              | Standard | Certificate Name |
|---------------------------------------|----------|------------------|
| CCA<br>DEKRA Certification B.V.       | EN 60947 | NTR NL 7962      |
| CSA<br>DEKRA Certification B.V.       | C22.2    | 2130762          |
| KEMA/KEUR<br>DEKRA Certification B.V. | EN 60947 | 71-125928        |
| UL<br>Underwriters Laboratories Inc.  | UL 1059  | E45172           |

#### Declarations of conformity and manufacturer's declarations



| Approval   | Standard | Certificate Name |
|--|----------|------------------|
| ATEX-Attestation of Conformity<br>WAGO GmbH & Co. KG | -        | -                |
| EU-Declaration of Conformity<br>WAGO GmbH & Co. KG   | -        | -                |
| Railway<br>WAGO GmbH & Co. KG                        | -        | Railway Ready    |
| UK-Declaration of Conformity<br>WAGO GmbH & Co. KG   | -        | -                |

#### Approvals for marine applications



| Approval   | Standard | Certificate Name  |
|--|----------|-------------------|
| ABS<br>American Bureau of Shipping               | EN 60947 | 24-0152298-PDA    |
| DNV GL<br>Det Norske Veritas, Germanischer Lloyd | -        | TAE00001V2        |
| LR<br>Lloyds Register                            | EN 60947 | LR23325966TA      |
| PRS<br>Polski Rejestr Statków                    | -        | TE/1094/880590/23 |

#### Approvals for hazardous areas



| Approval                                       | Standard    | Certificate Name   |
|--|-------------|--|
| AEx<br>Underwriters Laboratories Inc.          | UL 60079    | E185892 (AEx eb IIC resp. Ex eb IIC)                           |
| ATEX<br>Physikalisch Technische Bundesanstalt  | EN 60079    | PTB 11 ATEX 1041 U (II 2 G Ex eb IIC Gb bzw. I M 2 Ex eb I Mb) |
| CCC<br>CNEX                                    | GB/T 3836.3 | 2020312313000182 (Ex eb IIC Gb, Ex eb I Mb)                    |
| IECEx<br>Physikalisch Technische Bundesanstalt | IEC 60079   | IECEx PTB 11.0093U (Ex e IIC Gb or Ex e I Mb)                  |

Downloads

Environmental Product Compliance

Compliance Search

Environmental Product Compliance 2000-1202



Documentation

Bid Text

|           |            |                  |  |
|-----------|------------|------------------|--|
| 2000-1202 | 19.02.2019 | xml<br>3.93 KB   |  |
| 2000-1202 | 07.08.2018 | docx<br>14.58 KB |  |

CAD/CAE-Data

CAD data

|                           |  |
|---------------------------|--|
| 2D/3D Models<br>2000-1202 |  |
|---------------------------|--|

CAE data

|                                |  |
|--------------------------------|--|
| EPLAN Data Portal<br>2000-1202 |  |
| WSCAD Universe<br>2000-1202    |  |
| ZUKEN Portal<br>2000-1202      |  |

1 Compatible Products

1.1 Required Accessories

1.1.1 End plate

1.1.1.1 End plate



**Item No.: 2000-1291**  
End and intermediate plate; 0.7 mm thick; gray



**Item No.: 2000-1292**  
End and intermediate plate; 0.7 mm thick; orange



**Item No.: 209-191**  
Separator for Ex e/Ex i applications; 3 mm thick; 120 mm wide; orange

1.2 Optional Accessories

1.2.1 DIN-rail

1.2.1.1 Mounting accessories



**Item No.: 210-196**  
Aluminum carrier rail; 35 x 8.2 mm; 1.6 mm thick; 2 m long; unslotted; similar to EN 60715; silver-colored



**Item No.: 210-198**  
Copper carrier rail; 35 x 15 mm; 2.3 mm thick; 2 m long; unslotted; according to EN 60715; copper-colored



**Item No.: 210-197**  
Steel carrier rail; 35 x 15 mm; 1.5 mm thick; 2 m long; slotted; similar to EN 60715; silver-colored



**Item No.: 210-114**  
Steel carrier rail; 35 x 15 mm; 1.5 mm thick; 2 m long; unslotted; similar to EN 60715; silver-colored



**Item No.: 210-118**  
Steel carrier rail; 35 x 15 mm; 2.3 mm thick; 2 m long; unslotted; according to EN 60715; silver-colored



**Item No.: 210-115**  
Steel carrier rail; 35 x 7.5 mm; 1 mm thick; 2 m long; slotted; according to EN 60715; "Hole width 18 mm; silver-colored



**Item No.: 210-112**  
Steel carrier rail; 35 x 7.5 mm; 1 mm thick; 2 m long; slotted; according to EN 60715; "Hole width 25 mm; silver-colored



**Item No.: 210-113**  
Steel carrier rail; 35 x 7.5 mm; 1 mm thick; 2 m long; unslotted; according to EN 60715; silver-colored

1.2.2 End plate

1.2.2.1 End plate



**Item No.: 209-190**

Separator for Ex e/Ex i applications; 3 mm thick; 90 mm wide; orange

1.2.3 Ferrule

1.2.3.1 Ferrule



**Item No.: 216-241**

Ferrule; Sleeve for 0.5 mm<sup>2</sup> / 20 AWG; insulated; electro-tin plated; electrolytic copper; gastight crimped; acc. to DIN 46228, Part 4/09.90; white



**Item No.: 216-242**

Ferrule; Sleeve for 0.75 mm<sup>2</sup> / 18 AWG; insulated; electro-tin plated; electrolytic copper; gastight crimped; acc. to DIN 46228, Part 4/09.90; gray



**Item No.: 216-243**

Ferrule; Sleeve for 1 mm<sup>2</sup> / AWG 18; insulated; electro-tin plated; electrolytic copper; gastight crimped; acc. to DIN 46228, Part 4/09.90; red

1.2.4 Installation

1.2.4.1 Cover



**Item No.: 709-156**

Cover; Type 3; suitable for cover carrier, type 3; 1 m long; transparent

1.2.4.2 Cover carrier



**Item No.: 709-169**

Cover carrier; Type 3; incl. fixing/retaining screws and knurled nut; suitable for 279 to 282 and 880 Series rail-mounted terminal blocks; suitable for 264 Series miniature rail-mounted terminal blocks; suitable for 270 Series sensor and actuator terminal blocks; gray

1.2.5 Jumper

1.2.5.1 Jumper



**Item No.: 2000-406/020-000**

Delta jumper; insulated; light gray



**Item No.: 2000-410/000-006**

Jumper; 10-way; insulated; blue



**Item No.: 2000-410**

Jumper; 10-way; insulated; light gray



**Item No.: 2000-410/000-005**

Jumper; 10-way; insulated; red



**Item No.: 2000-402/000-006**

Jumper; 2-way; insulated; blue



**Item No.: 2000-402**

Jumper; 2-way; insulated; light gray



**Item No.: 2000-402/000-005**

Jumper; 2-way; insulated; red



**Item No.: 2000-402/000-018**

Jumper; 2-way; insulated; yellow-green



**Item No.: 2000-403/000-006**

Jumper; 3-way; insulated; blue



**Item No.: 2000-403**

Jumper; 3-way; insulated; light gray



**Item No.: 2000-403/000-005**































Jumper; 3-way; insulated; red



**Item No.: 2000-404/000-006**

Jumper; 4-way; insulated; blue

1.2.5.1 Jumper











|   |   |  |   |
|---|---|--|---|
| <br><b>Item No.: 2000-404</b><br>Jumper; 4-way; insulated; light gray        | <br><b>Item No.: 2000-404/000-005</b><br>Jumper; 4-way; insulated; red       | <br><b>Item No.: 2000-405/000-006</b><br>Jumper; 5-way; insulated; blue       | <br><b>Item No.: 2000-405</b><br>Jumper; 5-way; insulated; light gray                    |
| <br><b>Item No.: 2000-405/000-005</b><br>Jumper; 5-way; insulated; red       | <br><b>Item No.: 2000-406/000-006</b><br>Jumper; 6-way; insulated; blue      | <br><b>Item No.: 2000-406</b><br>Jumper; 6-way; insulated; light gray         | <br><b>Item No.: 2000-406/000-005</b><br>Jumper; 6-way; insulated; red                   |
| <br><b>Item No.: 2000-407/000-006</b><br>Jumper; 7-way; insulated; blue      | <br><b>Item No.: 2000-407</b><br>Jumper; 7-way; insulated; light gray        | <br><b>Item No.: 2000-407/000-005</b><br>Jumper; 7-way; insulated; red        | <br><b>Item No.: 2000-408/000-006</b><br>Jumper; 8-way; insulated; blue                  |
| <br><b>Item No.: 2000-408</b><br>Jumper; 8-way; insulated; light gray        | <br><b>Item No.: 2000-408/000-005</b><br>Jumper; 8-way; insulated; red       | <br><b>Item No.: 2000-409/000-006</b><br>Jumper; 9-way; insulated; blue       | <br><b>Item No.: 2000-409</b><br>Jumper; 9-way; insulated; light gray                    |
| <br><b>Item No.: 2000-409/000-005</b><br>Jumper; 9-way; insulated; red       | <br><b>Item No.: 2000-440</b><br>Jumper; from 1 to 10; insulated; light gray | <br><b>Item No.: 2000-433/000-006</b><br>Jumper; from 1 to 3; insulated; blue | <br><b>Item No.: 2000-433</b><br>Jumper; from 1 to 3; insulated; light gray              |
| <br><b>Item No.: 2000-433/000-005</b><br>Jumper; from 1 to 3; insulated; red | <br><b>Item No.: 2000-434</b><br>Jumper; from 1 to 4; insulated; light gray  | <br><b>Item No.: 2000-435</b><br>Jumper; from 1 to 5; insulated; light gray   | <br><b>Item No.: 2000-436</b><br>Jumper; from 1 to 6; insulated; light gray              |
| <br><b>Item No.: 2000-437</b><br>Jumper; from 1 to 7; insulated; light gray  | <br><b>Item No.: 2000-438</b><br>Jumper; from 1 to 8; insulated; light gray  | <br><b>Item No.: 2000-439</b><br>Jumper; from 1 to 9; insulated; light gray   | <br><b>Item No.: 2000-405/011-000</b><br>Star point jumper; 3-way; insulated; light gray |
| <br><b>Item No.: 210-103</b><br>Wire commoning chain; insulated; black     | <br><b>Item No.: 210-123</b><br>Wire commoning chain; insulated; blue      |  |   |

1.2.6 Marking

1.2.6.1 Group marker carrier

|  |
|--|
| <br><b>Item No.: 2009-191</b><br>Group marker carrier; gray |
|--|

1.2.6.2 Marker

|  |   |  |   |
|--|---|--|---|
| <br><b>Item No.: 793-3501</b><br>WMB marking card; as card; plain; snap-on type; white  | <br><b>Item No.: 2009-113/000-006</b><br>WMB-Inline; for Smart Printer; 2300 pieces on roll; plain; snap-on type; blue   | <br><b>Item No.: 2009-113/000-007</b><br>WMB-Inline; for Smart Printer; 2300 pieces on roll; plain; snap-on type; gray | <br><b>Item No.: 2009-113/000-023</b><br>WMB-Inline; for Smart Printer; 2300 pieces on roll; plain; snap-on type; green  |
| <br><b>Item No.: 2009-113/000-017</b><br>WMB-Inline; for Smart Printer; 2300 pieces on roll; plain; snap-on type; light green | <br><b>Item No.: 2009-113/000-012</b><br>WMB-Inline; for Smart Printer; 2300 pieces on roll; plain; snap-on type; orange | <br><b>Item No.: 2009-113/000-005</b><br>WMB-Inline; for Smart Printer; 2300 pieces on roll; plain; snap-on type; red  | <br><b>Item No.: 2009-113/000-024</b><br>WMB-Inline; for Smart Printer; 2300 pieces on roll; plain; snap-on type; violet |
| <br><b>Item No.: 2009-113</b><br>WMB-Inline; for Smart Printer; 2300 pieces on roll; plain; snap-on type; white               | <br><b>Item No.: 2009-113/000-002</b><br>WMB-Inline; for Smart Printer; 2300 pieces on roll; plain; snap-on type; yellow |  |   |

1.2.6.3 Marking strip



**Item No.: 2009-110**

Marking strips; for Smart Printer; on reel; not stretchable; plain; snap-on type; white

1.2.7 Protective warning marker

1.2.7.1 Cover



**Item No.: 2000-115**

Protective warning marker; for 5 terminal blocks; with high-voltage symbol, black; yellow

1.2.8 Push-in type wire jumper

1.2.8.1 Jumper



**Item No.: 2009-404**

Push-in type wire jumper; 0.75 mm<sup>2</sup>; insulated; 110 mm long; gray



**Item No.: 2009-406**

Push-in type wire jumper; 0.75 mm<sup>2</sup>; insulated; 250 mm long; gray



**Item No.: 2009-402**

Push-in type wire jumper; 0.75 mm<sup>2</sup>; insulated; 60 mm long; gray

1.2.9 Screwless end stop

1.2.9.1 Mounting accessories



**Item No.: 249-117**

Screwless end stop; 10 mm wide; for DIN-rail 35 x 15 and 35 x 7.5; gray



**Item No.: 249-116**

Screwless end stop; 6 mm wide; for DIN-rail 35 x 15 and 35 x 7.5; gray

1.2.10 Test and measurement

1.2.10.1 Testing accessories



**Item No.: 2000-560**

Modular TOPJOB®S connector; modular; for jumper contact slot; 10-pole; gray



**Item No.: 2000-552**

Modular TOPJOB®S connector; modular; for jumper contact slot; 2-pole; gray



**Item No.: 2000-553**

Modular TOPJOB®S connector; modular; for jumper contact slot; 3-pole; gray



**Item No.: 2000-554**

Modular TOPJOB®S connector; modular; for jumper contact slot; 4-pole; gray



**Item No.: 2000-555**

Modular TOPJOB®S connector; modular; for jumper contact slot; 5-pole; gray



**Item No.: 2000-556**

Modular TOPJOB®S connector; modular; for jumper contact slot; 6-pole; gray



**Item No.: 2000-557**

Modular TOPJOB®S connector; modular; for jumper contact slot; 7-pole; gray



**Item No.: 2000-558**

Modular TOPJOB®S connector; modular; for jumper contact slot; 8-pole; gray



**Item No.: 2000-559**

Modular TOPJOB®S connector; modular; for jumper contact slot; 9-pole; gray



**Item No.: 2000-549**

Spacer module; modular; e.g., for bridging commoned terminal blocks; gray



**Item No.: 2009-174**

Test plug adapter; for 4 mm Ø test plugs; for testing TOPJOB®S rail-mounted terminal blocks; gray



**Item No.: 210-136**

Test plug; 2 mm Ø; with 500 mm cable; red

### 1.2.10.1 Testing accessories



**Item No.: 2009-182**

Testing tap; for max. 2.5 mm<sup>2</sup>; tool-free connection for individual test wires 0.08 - 2.5 mm; gray

**Item No.: 2000-511**

TOPJOB®S L-type test plug module; modular; for jumper contact slot; 1-pole; gray

**Item No.: 2000-510**

TOPJOB®S L-type test plug module; modular; for jumper contact slot; gray

### 1.2.11 Tool

#### 1.2.11.1 Operating tool



**Item No.: 210-719**

Operating tool; Blade: 2.5 x 0.4 mm; with a partially insulated shaft

**Item No.: 210-648**

Operating tool; Blade: 2.5 x 0.4 mm; with a partially insulated shaft; angled; short

**Item No.: 210-647**

Operating tool; Blade: 2.5 x 0.4 mm; with a partially insulated shaft; multicoloured

### Installation Notes

#### Conductor termination

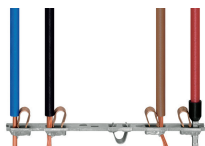

**All conductor types at a glance**

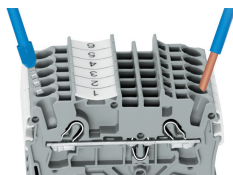

Push-in termination of solid and ferruled conductors

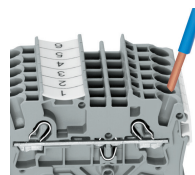

**Inserting a conductor via push-in termination:**

Solid conductors with cross-sections from either one size above, or up to two sizes below, the rated cross-section can be simply pushed in – no tools needed.

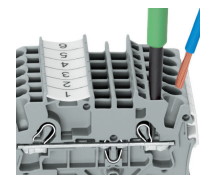

**Inserting a conductor via operating tool:**

Connecting fine-stranded conductors without ferrules, or small cross-sectional conductors that cannot be pushed in, is performed similarly to the original CAGE CLAMP® – just use an operating tool.

**Advantage:**

To open the clamp, the operating tool is inserted vertically. The conductor entry is less than 15 degrees for easier wiring.

#### Commoning

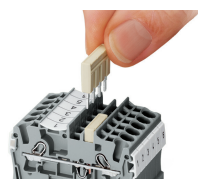

Insert push-in type jumper bar and push down until it hits backstop.

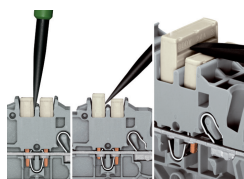

**Removing a push-in type jumper bar:**

Insert the operating tool between the jumper and partition wall of the dual jumper slots, then lift up the jumper. Place the operating tool in the center of jumpers for up to five contacts (see above), or alternately on both sides for jumpers with more than five contacts.

**Commoning**

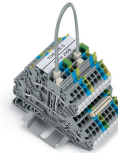
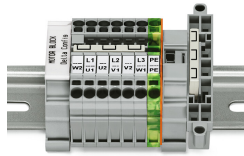
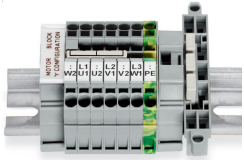

This star point jumper has been specially developed to create a "star point" and is used on motor terminal boards equipped with Rail-Mount Terminal Blocks TOPJOB® S.

This delta jumper has been specially developed to create a delta configuration and is used on motor terminal boards equipped with rail-mount terminal blocks TOPJOB® S.

Push down the wire jumper (2009-402) until fully inserted. For rewiring, lift the jumper with an operating tool at the notch provided for this purpose on the jumper.

**Testing**

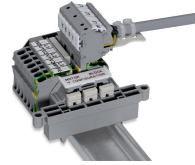
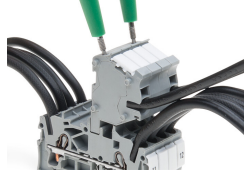
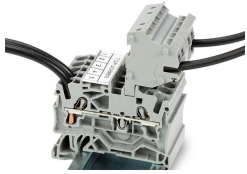

The modular TOPJOB® S connectors also connect conductors of the same size as the terminal blocks being used.

TOPJOB® S Connectors with a 2 mm Ø test socket for testing voltage via 2-pole voltage tester

Rail-mount terminal block assembly for electric motor wiring

Test plug adapter (Item No. 2009-174, CAT I) for 4 mm Ø plugs – compatible with 2000 to 2016 Series



Testing tap (Item No. 2009-182) for tool-free connection of test cables up to 2.5 mm² (12 AWG) – compatible with 2000 to 2016 Series

**Marking**

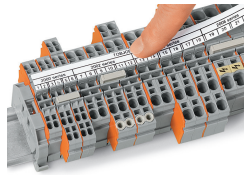
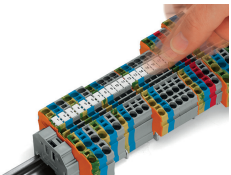

Snapping WMB Inline markers into marker slots.

TOPJOB® S 2009-193 Group Marker Carrier (equipped with a marking strip) for all 2001 to 2016 Series TOPJOB® S Rail-Mount Terminal Blocks  
Do not use on an end plate!

**Ex application**

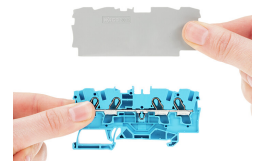
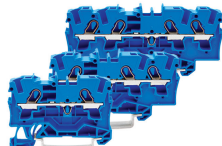
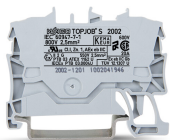

Through terminal blocks with blue insulated housing are suitable for Ex i applications.

All through and ground conductor terminal blocks are suitable for Ex e II applications.

**Separator plate for Ex e/Ex i applications**  
An end plate must be applied to the terminal block located directly behind an Ex e/Ex i separator plate.

## Ex application

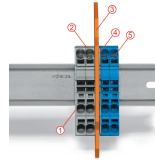

### Ex e II/Ex i terminal strip

#### Note:

The movable feet of terminal blocks and separator plates must face the same direction.

A separator plate is located between the Ex e II and Ex i terminal strip.

End plate

Ex e II terminal blocks

Separator plate for Ex e/Ex i applications

End plate

Ex i terminal blocks

According to EN 50020, a minimum distance of 50 mm must be kept between live parts of Ex e and Ex i circuits. The use of Ex e/Ex i separators is a space-saving solution when Ex e and Ex i terminal blocks are mounted on a common DIN-rail.