

Data Sheet | Item Number: 261-432/341-000

2-conductor terminal strip; on both sides with push-buttons; with fixing flanges; 12-pole; for screw or similar mounting types; Fixing hole 3.2 mm Ø; 2.5 mm²; CAGE CLAMP®; gray

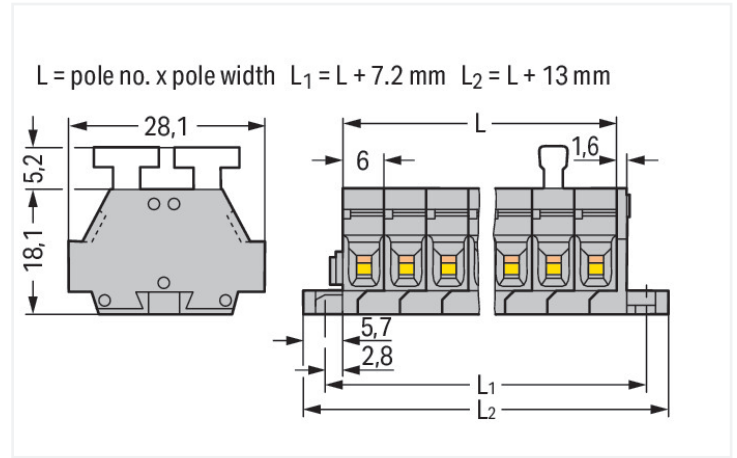

<https://www.wago.com/261-432/341-000>

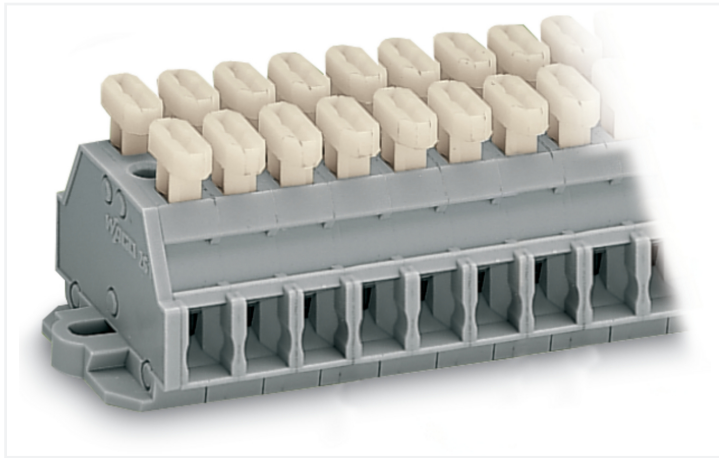

Color: ■ gray

Similar to illustration

Dimensions in mm

Through terminal block, 261 Series, CAGE CLAMP®

Our through terminal block (item number 261-432/341-000) is designed for seamless electrical installations. Ensure that the strip lengths are between 8 and 9 mm when connecting conductors to this through terminal block. Our mini rail-mount terminal blocks are the perfect choice for working in confined spaces. A large selection of mounting and actuation variants means you can find a suitable mini terminal block for every purpose. This also means you can adapt the terminal blocks to your unique requirements. This product features conductor terminals and utilizes CAGE CLAMP®. Our reliable and maintenance-free CAGE CLAMP® connection makes it easy to connect all conductor types without having to prepare the conductor. For example, you don't need to crimp ferrules. Dimensions: (85 x 28.1 x 23.3) mm (width x height x depth). This through terminal block is suitable for conductor cross sections ranging from 0.08 mm² to 2.5 mm².

A push-button is used to operate this mini rail-mount terminal block.

Electrical data

Ratings per IEC/EN	
Nominal voltage (III/3)	500 V
Rated impulse withstand voltage (III / 3)	6 kV
Rated current	24 A
Legend (ratings)	(III / 3) ≙ Overvoltage category III / Pollution degree 3

Approvals per	UL 1059		
	B	C	D
Use group	B	C	D
Rated voltage	300 V	300 V	600 V
Rated current	15 A	15 A	5 A

Approvals per	CSA 22.2 No 158		
	B	C	D
Use group	B	C	D
Rated voltage	-	300 V	600 V
Rated current	-	10 A	5 A

General information	
Wiring direction	Side-entry wiring

Connection Data

Clamping units	24
Total number of potentials	12
Number of levels	1

Connection 1

Connection technology	CAGE CLAMP®
Actuation type	Push-button
Connectable conductor materials	Copper
Solid conductor	0.08 ... 2.5 mm ² / 28 ... 14 AWG
Fine-stranded conductor	0.08 ... 2.5 mm ² / 28 ... 14 AWG
Strip length	8 ... 9 mm / 0.31 ... 0.35 inches
Pole number	12
Wiring direction	Side-entry wiring

Physical data

Width	85 mm / 3.346 inches
Height	28.1 mm / 1.106 inches
Depth	23.3 mm / 0.917 inches
Module width	6 mm / 0.236 inches

Mechanical data

Design	horizontal type
Mounting type	Mounting flange
Marking level	Side marking

Material data

Note (material data)	Information on material specifications can be found here
Color	gray
Material group	I
Insulation material (main housing)	Polyamide (PA66)
Flammability class per UL94	V0
Fire load	0.318 MJ
Halogen-free	Yes
Weight	33.6 g

Commercial data

PU (SPU)	25 pcs
Packaging type	Box
Country of origin	DE
GTIN	4044918627511
Customs tariff number	85369010000

Product Classification

UNSPSC	39121410
eCl@ss 10.0	27-14-11-06
eCl@ss 9.0	27-14-11-06
ETIM 9.0	EC001284
ETIM 10.0	EC001284
ECCN	NO US CLASSIFICATION

Environmental Product Compliance

RoHS Compliance Status	Compliant, No Exemption
------------------------	-------------------------

Downloads

Environmental Product Compliance

Compliance Search	
Environmental Product Compliance 261-432/341-000	↓

Documentation

Bid Text			
261-432/341-000	19.02.2019	xml 3.17 KB	↓
261-432/341-000	17.08.2017	doc 25.00 KB	↓

CAD/CAE-Data

CAD data	
2D/3D Models 261-432/341-000	↓

CAE data	
EPLAN Data Portal 261-432/341-000	↓
WSCAD Universe 261-432/341-000	↓
ZUKEN Portal 261-432/341-000	↓

1 Compatible Products

1.1 Optional Accessories

1.1.1 Ferrule

1.1.1.1 Ferrule

<p>Item No.: 216-301 Ferrule; Sleeve for 0.25 mm² / AWG 24; insulated; electro-tin plated; yellow</p>	<p>Item No.: 216-302 Ferrule; Sleeve for 0.34 mm² / 22 AWG; insulated; electro-tin plated; light turquoise</p>	<p>Item No.: 216-201 Ferrule; Sleeve for 0.5 mm² / 20 AWG; insulated; electro-tin plated; electrolytic copper; acc. to DIN 46228, Part 4/09.90; white</p>	<p>Item No.: 216-101 Ferrule; Sleeve for 0.5 mm² / AWG 22; un-insulated; electro-tin plated; silver-colored</p>
<p>Item No.: 216-202 Ferrule; Sleeve for 0.75 mm² / 18 AWG; insulated; electro-tin plated; gray</p>	<p>Item No.: 216-102 Ferrule; Sleeve for 0.75 mm² / AWG 20; un-insulated; electro-tin plated; silver-colored</p>	<p>Item No.: 216-203 Ferrule; Sleeve for 1 mm² / AWG 18; insulated; electro-tin plated; red</p>	<p>Item No.: 216-103 Ferrule; Sleeve for 1 mm² / AWG 18; un-insulated; electro-tin plated</p>
<p>Item No.: 216-204 Ferrule; Sleeve for 1.5 mm² / AWG 16; insulated; electro-tin plated; black</p>	<p>Item No.: 216-104 Ferrule; Sleeve for 1.5 mm² / AWG 16; un-insulated; electro-tin plated; silver-colored</p>	<p>Item No.: 216-205 Ferrule; Sleeve for 2.08 mm² / AWG 14; insulated; electro-tin plated; yellow</p>	<p>Item No.: 216-206 Ferrule; Sleeve for 2.5 mm² / AWG 14; insulated; electro-tin plated; blue</p>

1.1.1.1 Ferrule



Item No.: 216-106

Ferrule; Sleeve for 2.5 mm² / AWG 14; un-insulated; electro-tin plated; silver-colored

1.1.2 Installation

1.1.2.1 Mounting accessories



Item No.: 209-137

Mounting adapter; can be used as end stop; 6.5 mm wide; gray



Item No.: 209-123

Mounting foot with screw; can be screwed on terminal blocks with fixing flange; 6.4 mm wide; gray

1.1.3 Jumper

1.1.3.1 Jumper



Item No.: 261-402

Jumper; for conductor entry; 2-way; insulated; gray

1.1.4 Marking

1.1.4.1 Marker

Item No.: 2009-145/000-006

Mini-WSB Inline; for Smart Printer; 1700 pieces on roll; stretchable 5 - 5.2 mm; plain; snap-on type; blue

Item No.: 2009-145/000-007

Mini-WSB Inline; for Smart Printer; 1700 pieces on roll; stretchable 5 - 5.2 mm; plain; snap-on type; gray

Item No.: 2009-145/000-023

Mini-WSB Inline; for Smart Printer; 1700 pieces on roll; stretchable 5 - 5.2 mm; plain; snap-on type; green

Item No.: 2009-145/000-012

Mini-WSB Inline; for Smart Printer; 1700 pieces on roll; stretchable 5 - 5.2 mm; plain; snap-on type; orange

Item No.: 2009-145/000-005

Mini-WSB Inline; for Smart Printer; 1700 pieces on roll; stretchable 5 - 5.2 mm; plain; snap-on type; red

Item No.: 2009-145/000-024

Mini-WSB Inline; for Smart Printer; 1700 pieces on roll; stretchable 5 - 5.2 mm; plain; snap-on type; violet

Item No.: 2009-145

Mini-WSB Inline; for Smart Printer; 1700 pieces on roll; stretchable 5 - 5.2 mm; plain; snap-on type; white

Item No.: 2009-145/000-002

Mini-WSB Inline; for Smart Printer; 1700 pieces on roll; stretchable 5 - 5.2 mm; plain; snap-on type; yellow



Item No.: 248-501/000-006

Mini-WSB marking card; as card; not stretchable; plain; snap-on type; blue

Item No.: 248-501/000-007

Mini-WSB marking card; as card; not stretchable; plain; snap-on type; gray

Item No.: 248-501/000-023

Mini-WSB marking card; as card; not stretchable; plain; snap-on type; green

Item No.: 248-501/000-017

Mini-WSB marking card; as card; not stretchable; plain; snap-on type; light green



Item No.: 248-501/000-012

Mini-WSB marking card; as card; not stretchable; plain; snap-on type; orange

Item No.: 248-501/000-005

Mini-WSB marking card; as card; not stretchable; plain; snap-on type; red

Item No.: 248-501/000-024

Mini-WSB marking card; as card; not stretchable; plain; snap-on type; violet

Item No.: 248-501

Mini-WSB marking card; as card; not stretchable; plain; snap-on type; white



Item No.: 248-501/000-002

Mini-WSB marking card; as card; not stretchable; plain; snap-on type; yellow

1.1.5 Test and measurement

1.1.5.1 Testing accessories



Item No.: 210-136

Test plug; 2 mm Ø; with 500 mm cable; red

1.1.6 Tool

1.1.6.1 Operating tool



Item No.: 210-658

Operating tool; Blade: 3.5 x 0.5 mm; with a partially insulated shaft; angled; short; multicoloured



Item No.: 210-720

Operating tool; Blade: 3.5 x 0.5 mm; with a partially insulated shaft; multicoloured



Item No.: 210-657

Operating tool; Blade: 3.5 x 0.5 mm; with a partially insulated shaft; short; multicoloured

Installation Notes

Conductor termination

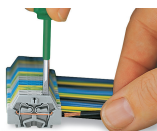

CAGE CLAMP® connection

Inserting a conductor.
With ferruled conductors, it is necessary to use a terminal block one size larger than the conductor's nominal cross-section.

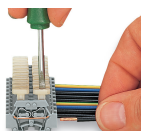

CAGE CLAMP® connection

Inserting a conductor via push-button.

Commoning

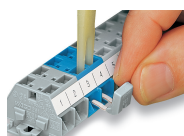

Commoning with comb-style jumper bar.

Testing

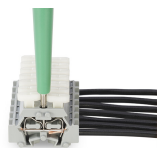

Testing with voltage tester.

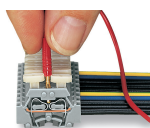

Testing with a 2 mm Ø test plug – touch contact.

Installation

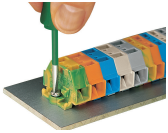

Mounting and securing a terminal strip directly to the plate via screw-type flanges.

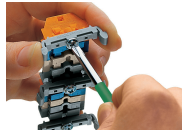

Terminal strip with mounting flanges
Screwing a mounting foot (209-123).
(Distance between mounting feet: approx. 25 ... 30 mm)

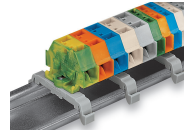

Terminal strip; with mounting flanges; for DIN-35 rail

Marking

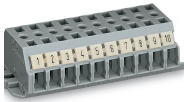

Terminal strip with marker slot for Mini-WSB Quick Marking System