

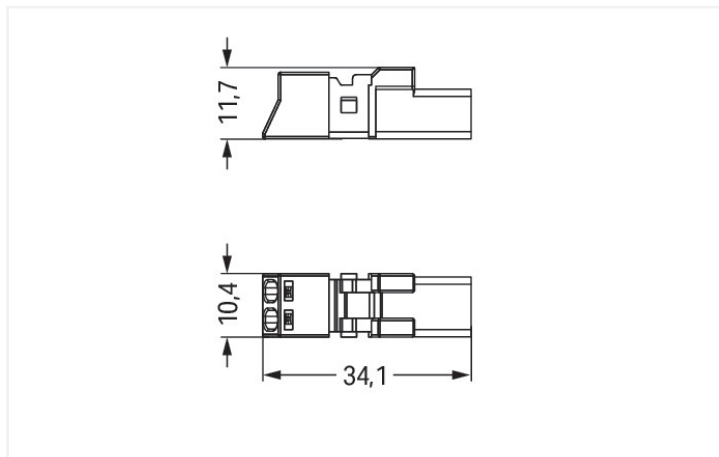

Color: ■ black



Dimensions in mm

Male connector/plug WINSTA® MINI rated current 16 A

The WINSTA® MINI male connector/plug with protection against mismatching allows assembly of fine-stranded and solid conductors. Whether on PCBs, in control cabinets or for connecting lights – pluggable installation connectors from WAGO allow you to make connections according to various requirements in no time flat. The mechanical coding and color coding of the pluggable installation connector ensure error-free installation of the individual components – including protection against mismatching. General mains applications for almost any domain of use can be implemented with WINSTA® MI-NI pluggable installation connectors with A coding. Especially where space is tight, our smallest pluggable connection system, WINSTA® MINI, consistently displays its strengths. It is very compact, and, with Push-in CAGE CLAMP® spring pressure connection technology, it additionally can be installed quickly, since the connection is low-maintenance and requires no screw connections.

Push-in CAGE CLAMP® spring pressure connection technology – pluggable installation instead of laborious screw connections!

The WINSTA® Pluggable Connection System is ideally tailored to the strict requirements of building installation. It makes electrical installation pluggable, and therefore more efficient, even more reliable, and error-free. Using this pre-assembled system reduces time spent on assembly and installation errors at the construction site. Choose durability and quality – with protection against mismatching from WAGO makes the installation of electrical components significantly easier.

- effective protection against mismatching
- compact design for conductors with a cross-section up to 1.5 mm<sup>2</sup>
- suitable for any application
- ready for immediate use
- rapid, structured electrical installation

## Notes

General safety information

**NOTICE: Observe installation and safety instructions!**

- Nur von Elektrofachkraft oder einer für die Tätigkeit elektrisch unterwiesenen Person (EUP nach DIN VDE 0105-100) anzuwenden!
- Nicht unter Spannung/Last installieren!
- Nur für bestimmungsgemäßen Gebrauch einsetzen!
- Nationale Vorschriften/Normen/Richtlinien beachten!
- Technische Daten der Produkte beachten!
- Auf die richtige Polbelegung achten!
- Keine beschädigten/verschmutzten Komponenten verwenden!
- Leiterarten, -querschnitte, Abisolierlängen und Leitungsdurchmesser beachten!
- Leiter bis zum Anschlag einführen!
- Nur mit Verriegelungsklinke und Zugentlastung verwenden!
- Originalzubehör verwenden!

**To be sold only with installation instructions!**

## Electrical data

Ratings per	IEC/EN 60664-1			Approvals per	UL 1977
Overvoltage category	III	III	II	Rated voltage	600 V
Pollution degree	3	2	2	Rated current	14 A
Nominal voltage	250 V	-	-		
Rated impulse withstand voltage	4 kV	-	-		
Rated current	16 A	-	-		

## General information

Note on contact resistance	approx. 1 mΩ of contact resistance approx. 0.25 mΩ contact transition plug/ socket
----------------------------	--

## Connection Data

Clamping units	2	<b>Connection 1</b>	
Total number of potentials	2	Connection technology	Push-in CAGE CLAMP®
		Actuation type	Operating tool Push-in
		Nominal cross-section	1.5 mm <sup>2</sup> / 16 AWG
		Solid conductor	0.25 ... 1.5 mm <sup>2</sup> / 22 ... 16 AWG
		Solid conductor; push-in termination	0.75 ... 1.5 mm <sup>2</sup> / 20 ... 16 AWG
		Stranded conductor	0.25 ... 1 mm <sup>2</sup> / 22 ... 18 AWG
		Fine-stranded conductor	0.25 ... 1.5 mm <sup>2</sup> / 22 ... 16 AWG
		Fine-stranded conductor; with insulated ferrule	0.25 ... 0.75 mm <sup>2</sup> / 22 ... 20 AWG
		Fine-stranded conductor; with uninsulated ferrule	0.25 ... 0.75 mm <sup>2</sup> / 22 ... 20 AWG
		Fine-stranded conductor; with ferrule; push-in termination	0.75 mm <sup>2</sup> / 20 AWG
		Strip length	9 mm / 0.35 inches
		Pole number	2
		Conductor entry direction to mating direction	0°

## Physical data

Pin spacing	4.4 mm / 0.173 inches
Width	10.4 mm / 0.409 inches
Height	11.7 mm / 0.461 inches
Depth	34.1 mm / 1.343 inches

## Mechanical data

Use	General mains applications
Coding	A
Variable coding	No
Marking	N L
Potential marking	N L
Mating force of a plug-in connection	approx. 20 ... 70 N (depending on pole number)
Retention force of a plug-in connection	Locked: > 80 N
Unmating force of a plug-in connection	Unlocked: approx. 20 ... 70 N (depending on pole number)
Number of mating cycles	200, without resistive load
Protection type	IP20; IP40 when mated with strain relief housing

### Plug-in connection

Contact type (pluggable connector)	Male connector/plug
Connector (connection type)	for conductor
Mismating protection	Yes
Note on mismating protection	All WINSTA® components are 100% protected against mismating when: a.) plugging different numbers of poles b.) plugging while rotated 180 c.) plugging while laterally staggered d.) plugging one pole
Locking lever	Can be retrofitted
Locking of plug-in connection	Locking lever
Note on locking system	All connectors for mounted installations (snap-in versions for lighting fixtures or devices, all types of PCB and distribution connectors) are factory-equipped with locking levers to ensure plugs and sockets are securely locked. Additional locking levers are only required for flying leads (plug/socket).

### Material data

Note (material data)	<a href="#">Information on material specifications can be found here</a>
Color	black
Cover color	gray
Material group	I
Insulation material (main housing)	Polyamide (PA66)
Flammability class per UL94	V0
Clamping spring material	Chrome-nickel spring steel (CrNi)
Contact material	Copper or copper alloy; surface-treated
Contact Plating	Tin
Fire load	0.057 MJ
Weight	2.5 g

### Environmental requirements

Processing temperature	-5 ... +40 °C
Continuous operating temperature	-35 ... +85 °C
Note on continuous operating temperature	Insulating parts for temperatures ≤ 105 °C

### Commercial data



Product Group	20 (Winsta)
PU (SPU)	50 pcs
Packaging type	Box
Country of origin	PL
GTIN	4055143548489
Customs tariff number	85366990990

### Product Classification





UNSPSC	39121402
eCl@ss 10.0	27-44-06-05
eCl@ss 9.0	27-44-06-05
ETIM 9.0	EC002560
ETIM 10.0	EC002560
ECCN	NO US CLASSIFICATION

Environmental Product Compliance	
RoHS Compliance Status	Compliant, No Exemption

### Approvals / Certificates

General approvals			Declarations of conformity and manufacturer's declarations		
 					
Approval	Standard	Certificate Name	Approval	Standard	Certificate Name
CCA DEKRA Certification B.V.	EN 61535	71-123231	EU-Declaration of Confor- mity WAGO GmbH & Co. KG	-	-
CCA DEKRA Certification B.V.	IEC 61535	NL-85020	UK-Declaration of Confor- mity WAGO GmbH & Co. KG	-	-
cURus Underwriters Laboratories Inc.	UL 1977	E45171			

### Approvals for marine applications

   		
Approval	Standard	Certificate Name
ABS American Bureau of Ship- ping	Steel Vessel Rules	24-0095973-PDA
DNV GL Det Norske Veritas, Ger- manischer Lloyd	-	TAE00001Z6
LR Lloyds Register	EN 61535	LR23317167TA
PRS Polski Rejestr Statków	-	TE/1096/880590/23

### Downloads

Environmental Product Compliance	
Compliance Search	
Environmental Product Compliance 890-212	<a href="#">↓</a>

### Documentation

Bid Text			
890-212	19.02.2019	xml 2.96 KB	<a href="#">↓</a>
890-212	08.06.2015	doc 23.00 KB	<a href="#">↓</a>

CAD/CAE-Data

CAD data	CAE data
2D/3D Models 890-212	EPLAN Data Portal 890-212
	WSCAD Universe 890-212
	ZUKEN Portal 890-212

1 Compatible Products

1.1 System counterpart

1.1.1 Cable assembly



**Item No.: 891-8992/105-101**  
pre-assembled connecting cable; Eca; Socket/open-ended; 2-pole; Cod. A; H05VV-F 2 x 1.0 mm<sup>2</sup>; 1 m; 1,00 mm<sup>2</sup>; black

**Item No.: 891-8992/005-101**  
pre-assembled interconnecting cable; Eca; Socket/plug; 2-pole; Cod. A; H05VV-F 2 x 1.0 mm<sup>2</sup>; 1 m; 1,00 mm<sup>2</sup>; black

1.1.2 Distribution connector



**Item No.: 890-1634**  
h-distribution connector; 2-pole; Cod. A; 1 input; 2 outputs; outputs on one side; 2 locking levers; black

**Item No.: 890-1636**  
h-distribution connector; 2-pole; Cod. A; 1 input; 2 outputs; outputs on one side; 3 locking levers; for flying leads; black

**Item No.: 890-1606**  
T-distribution connector; 2-pole; Cod. A; 1 input; 2 outputs; 2 locking levers; black

**Item No.: 890-1615**  
T-distribution connector; 2-pole; Cod. A; 1 input; 2 outputs; 3 locking levers; for flying leads; black

1.1.3 Female connector/socket



**Item No.: 890-702**  
Snap-in socket; 2-pole; Cod. A; 1,50 mm<sup>2</sup>; black

**Item No.: 890-802/011-000**  
Socket for PCBs; angled; 2-pole; Cod. A; black

**Item No.: 890-802**  
Socket for PCBs; straight; 2-pole; Cod. A; black

**Item No.: 890-202**  
Socket; 2-pole; Cod. A; 1,50 mm<sup>2</sup>; black



**Item No.: 890-102**  
Socket; with strain relief housing; 2-pole; Cod. A; 1,50 mm<sup>2</sup>; black

**Item No.: 890-202/342-000**  
Socket; with strain relief housing; 2-pole; Cod. A; 1,50 mm<sup>2</sup>; black

1.2 Required Accessories

1.2.1 Locking system

1.2.1.1 Locking system



**Item No.: 890-111**  
Locking lever; for flying leads; for tool operation; black

**Item No.: 890-131**  
Locking lever; for flying leads; for tool operation; white

**Item No.: 890-101**  
Locking lever; for manual operation; black

**Item No.: 890-121**  
Locking lever; for manual operation; white

## 1.2.2 Strain relief

### 1.2.2.1 Strain relief housing



**Item No.: 890-502/342-000**

Strain relief housing; 2-pole; with locking clip; for 1 cable; 3.8 ... 8.2 mm; 17.5 mm; black

**Item No.: 890-512/342-000**

Strain relief housing; 2-pole; with locking clip; for 1 cable; 3.8 ... 8.2 mm; 17.5 mm; white

**Item No.: 890-502**

Strain relief housing; 2-pole; with locking clip; for 1 cable; 3.8 ... 8.2 mm; 30 mm; black

**Item No.: 890-512**

Strain relief housing; 2-pole; with locking clip; for 1 cable; 3.8 ... 8.2 mm; 30 mm; white

## 1.3 Optional Accessories

### 1.3.1 Cover

#### 1.3.1.1 Cover



**Item No.: 897-2001**

Protective cap; Type1; for sockets and plugs; PVC; red

### 1.3.2 Installation

#### 1.3.2.1 Mounting accessories



**Item No.: 890-310**

Mounting carrier; 2- to 5-pole; for flying leads; black

**Item No.: 890-311**

Mounting carrier; 2- to 5-pole; for flying leads; white

### 1.3.3 Tool

#### 1.3.3.1 Operating tool



**Item No.: 890-382**

Operating tool; 2-way; green

**Item No.: 210-719**

Operating tool; Blade: 2.5 x 0.4 mm; with a partially insulated shaft

## Installation Notes

### Conductor termination

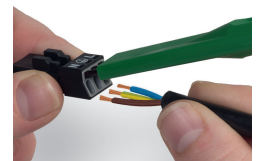
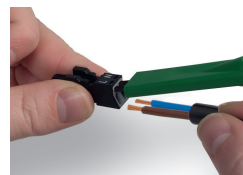
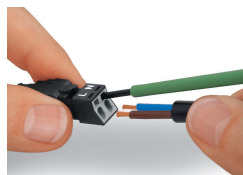

1. Strip length, outer insulation = 30 mm (2-pole), 37 mm (3-pole), 45 mm (4- and 5-pole)
2. Strip length = 9 mm
3. Extended ground conductor = 8 mm

To terminate fine-stranded conductors, open the clamping unit via screwdriver – 2.5 mm blade width – and insert a stripped conductor until it hits the backstop. Terminate solid conductors by simply pushing them in.

To terminate fine-stranded conductors, open clamping units via operating tool (890-382) and insert stripped conductors until they hit backstop. Terminate solid conductors by simply pushing them in.

To terminate fine-stranded conductors, open clamping units via operating tool (890-383) and insert stripped conductors until they hit backstop. Terminate solid conductors by simply pushing them in.

Installation



Latch the wired connector into the base of the strain relief housing.



Push down strain relief clamp by hand.



Push down strain relief clamp with 2.5 mm screwdriver alternately on both sides.

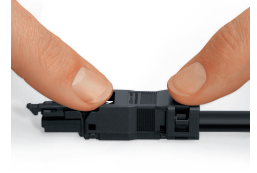

Latch the top of the strain relief housing.



The printed marking of the connector is clearly visible in the openings of the strain relief housing.