



IP67 (CCC optional) DALI (for DA2-Type only) DALI (for DA-Type only)

EL, 110, M, SELV, IS 15885, C US E320521, C US E334687 Type HL, 05, CCC, CB, CE, UK CA, EAC

AC Input: 100-240Vac (for DA2-Type only)

(for 12,24,48 Blank and 12,24 -DA2 Type)

(for 12,24 Blank Type only) (except for DA-Type)

Features

- Constant Voltage PWM style output
• Emergency lighting application is available according to IEC61347-2-13
• Built-in active PFC function and class II/2 design
• No load power consumption <0.5W
• Fully encapsulated with IP67 level
• Function: 3 in 1 dimming(dim-to-off); DALI/DALI-2
• Minimum dimming level 0.2% for DALI type
• Typical lifetime>50000 hours and 5 years warranty

Applications

- LED strip lighting
• Indoor LED lighting
• LED decorative lighting
• LED architecture lighting
• Industrial lighting
• Type "HL" for use in Class I, Division 2 hazardous (Classified) location.

GTIN CODE

MW Search: https://www.meanwell.com/serviceGTIN.aspx

Description

PWM-60 series is a 60W LED AC/DC LED driver featuring the constant voltage mode with PWM style output, which is able to maintain the brightness homogeneity when driving all kinds of LED strips. PWM-60 operates from 90~305VAC and offers models with different rated voltage ranging between 12V and 48V. Thanks to the high efficiency up to 90%, with the fanless design, the entire series is able to operate for -40°C ~ +85°C case temperature under free air convection. The entire series is rated with IP67 ingress protection level and is suitable to work for dry, damp or wet locations. PWM-60 is equipped with dimming function that varies the duty cycle of the output, providing great flexibility for LED strips applications.

Model Encoding

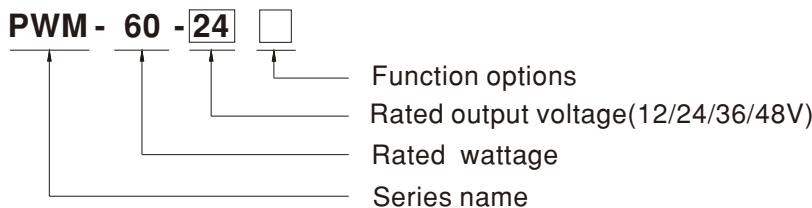

Table with 4 columns: Type, IP Level, Function, Note. Rows include Blank, DA, and DA2 models.

SPECIFICATION

MODEL	PWM-60-12□	PWM-60-24□	PWM-60-36□	PWM-60-48□	
OUTPUT	DC VOLTAGE	12V	24V	36V	48V
	RATED CURRENT	5A	2.5A	1.67A	1.25A
	RATED POWER	60W	60W	60.12W	60W
	DIMMING RANGE	0 ~ 100%			
	PWM FREQUENCY (Typ.)	1.47kHz for Blank/DA-Type, 2.5kHz for DA2-Type			
	SETUP, RISE TIME <small>Note.2 Note.9</small>	500ms, 80ms/ 115VAC or 230VAC			
	HOLD UP TIME (Typ.)	16ms/115VAC or 230VAC			
INPUT	VOLTAGE RANGE <small>Note.3</small>	90 ~ 305VAC 127 ~ 431VDC (Please refer to "STATIC CHARACTERISTIC" section)			
	FREQUENCY RANGE	47 ~ 63Hz			
	POWER FACTOR (Typ.)	PF>0.97/115VAC, PF>0.95/230VAC, PF>0.92/277VAC @ full load (Please refer to "POWER FACTOR (PF) CHARACTERISTIC" section)			
	TOTAL HARMONIC DISTORTION	THD< 20%(@load≥60%/115VAC, 230VAC; @load≥75%/277VAC) (Please refer to "TOTAL HARMONIC DISTORTION" section)			
	EFFICIENCY (Typ.)	86%	89%	90%	90%
	AC CURRENT (Typ.)	0.8A / 115VAC 0.4A / 230VAC 0.32A / 277VAC			
	INRUSH CURRENT (Typ.)	COLD START 50A(twidth=270μs measured at 50% Ipeak) at 230VAC; Per NEMA 410			
	MAX. NO. of PSUs on 16A CIRCUIT BREAKER	9 units (circuit breaker of type B) / 16 units (circuit breaker of type C) at 230VAC			
	LEAKAGE CURRENT	<0.25mA / 277VAC			
	NO LOAD POWER CONSUMPTION	<0.5W			
PROTECTION	OVERLOAD	108 ~ 130% rated output power Hiccup mode, recovers automatically after fault condition is removed			
	SHORT CIRCUIT	Shut down o/p voltage, re-power on to recover(except for DA2-type) Hiccup mode,recovers automatically after fault condition is removed (only for DA2-type)			
	OVER VOLTAGE	15 ~ 17V	28 ~ 34V	41 ~ 46V	54 ~ 60V
	OVER TEMPERATURE	Shut down o/p voltage, re-power on to recover			
ENVIRONMENT	WORKING TEMP.	Tcase=-40 ~ +85°C (Please refer to " OUTPUT LOAD vs TEMPERATURE" section)			
	MAX. CASE TEMP.	Tcase=+85°C			
	WORKING HUMIDITY	20 ~ 95% RH non-condensing			
	STORAGE TEMP., HUMIDITY	-40 ~ +80°C, 10 ~ 95% RH			
	TEMP. COEFFICIENT	±0.03%/°C (0 ~ 50°C)			
	VIBRATION	10 ~ 500Hz, 5G 12min./1cycle, period for 72min. each along X, Y, Z axes			
SAFETY & EMC	SAFETY STANDARDS <small>Note.5</small>	UL8750 (type "HL") (except for DA-Type), UL879(for 12V,24V Blank Type only), CSA C22.2 No. 250.13-12; ENEC BS EN/EN61347-1, BS EN/EN61347-2-13 independent, BS EN/EN62384, IP67,BIS IS 15885(Part2/Sec13)(for 12,24,48 Blank and 12,24-DA2 Type), EAC TP TC 004, GB19510.1,GB19510.14 approved; Design refer to BS EN/EN60335-1; According to BS EN/EN61347-2-13 appendix J suitable for emergency installations(EL) (AC Input: 100-240Vac)(for DA2-Type only)			
	DALI STANDARDS	IEC62386-101, 102, 207,251 for DA/DA2-Type only,Device type 6(DT6)			
	WITHSTAND VOLTAGE	I/P-O/P:3.75KVAC; I/P-DA:1.5KVAC; O/P-DA:1.5KVAC			
	ISOLATION RESISTANCE	I/P-O/P:100M Ohms / 500VDC / 25°C / 70% RH			
	EMC EMISSION <small>Note.6</small>	Compliance to BS EN/EN55015, BS EN/EN61000-3-2 Class C (@load ≥ 60%) ; BS EN/EN61000-3-3,GB/T 17743, GB17625.1;EAC TP TC 020			
	EMC IMMUNITY	Compliance to BS EN/EN61000-4-2,3,4,5,6,8,11; BS EN/EN61547, light industry level (surge immunity Line-Line 2KV),EAC TP TC 020			
OTHERS	MTBF	2626.6K hrs min. Telcordia SR-332 (Bellcore); 227.1K hrs min. MIL-HDBK-217F (25°C)			
	DIMENSION	150*53*35mm (L*W*H)			
	PACKING	0.49Kg;30pcs/15.7Kg/1.0CUFT			

NOTE

- All parameters NOT specially mentioned are measured at 230VAC input, rated current and 25°C of ambient temperature.
- De-rating may be needed under low input voltages. Please refer to "STATIC CHARACTERISTIC" sections for details.
- Length of set up time is measured at first cold start. Turning ON/OFF the driver may lead to increase of the set up time.
- The driver is considered as a component that will be operated in combination with final equipment. Since EMC performance will be affected by the complete installation, the final equipment manufacturers must re-qualify EMC Directive on the complete installation again. (as available on https://www.meanwell.com/Upload/PDF/EMI_statement_en.pdf)
- This series meets the typical life expectancy of >50,000 hours of operation when Tcase, particularly (tc) point (or TMP, per DLC), is about 75°C or less.
- Please refer to the warranty statement on MEAN WELL's website at <http://www.meanwell.com>
- The ambient temperature derating of 3.5°C/1000m with fanless models and of 5°C/1000m with fan models for operating altitude higher than 2000m(6500ft).
- For any application note and IP water proof function installation caution, please refer our user manual before using. https://www.meanwell.com/Upload/PDF/LED_EN.pdf
- Based on IEC 62386-101/102 DALI power on timing and interruption regulations, the set up time needs to test with a DALI controller which can support for DALI power on function, otherwise the set up time will be higher than 0.5 second for DA type.

DIMMING OPERATION

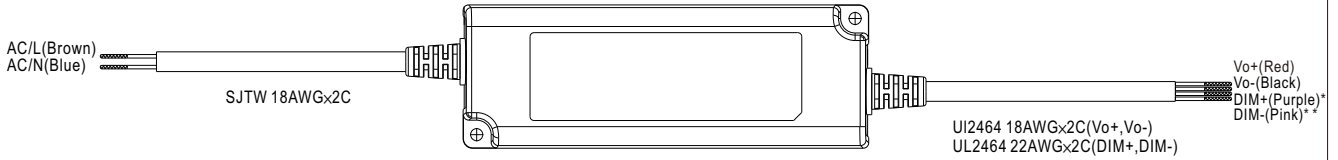

※ Dimming principle for PWM style output

- Dimming is achieved by varying the duty cycle of the output current.

* DIM+ for Blank-Type
DA+ for DA/DA2-type
**DIM- for Blank-Type
DA- for DA/DA2-type
NOTE: DA/DA2 Type is no distinction between "+" and "-" poles

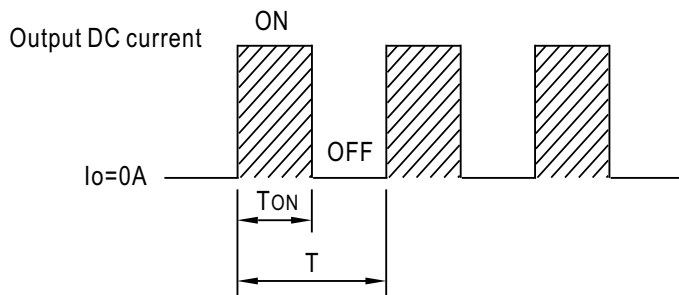

$$\text{Duty cycle(\%)} = \frac{T_{ON}}{T} \times 100\%$$

Output PWM frequency :
1.47kHz for Blank/DA-Type fixed (Typ.)
2.5kHz for DA2-Type fixed (Typ.)

※ 3 in 1 dimming function (for Blank-Type)

- Apply one of the three methodologies between DIM+ and DIM-: 0 ~ 10VDC, or 10V PWM signal or resistance.
- Dimming source current from power supply: 100µA (typ.)

◎ Applying additive 0 ~ 10VDC

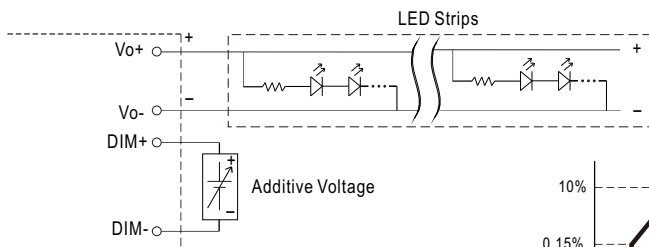

"DO NOT connect "DIM- to Vo-"

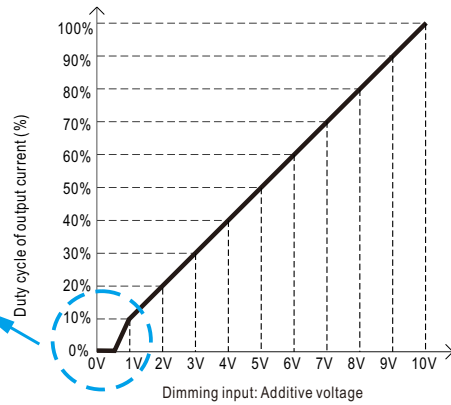
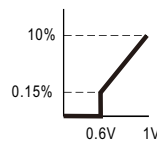

◎ Applying additive 10V PWM signal (frequency range 100Hz ~ 3KHz):

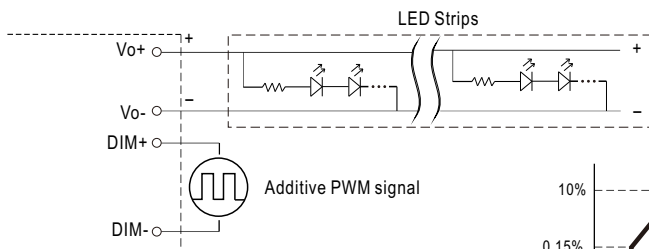

"DO NOT connect "DIM- to Vo-"

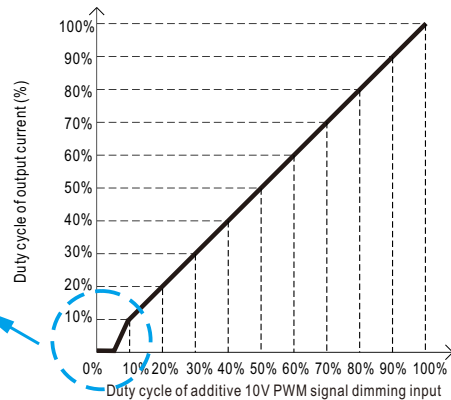
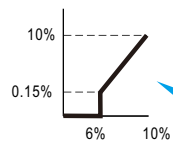

◎ Applying additive resistance:

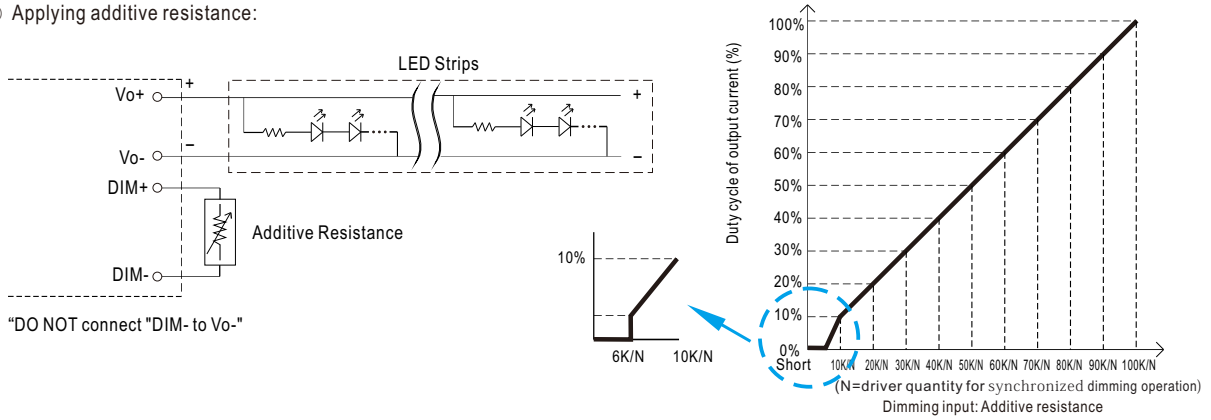

Note : 1. Min. duty cycle of output current is about 6% and the output current is not defined when $0\% < I_{out} < 6\%$.
 2. The duty cycle of output current could drop down to 0% when dimming input is about $0k\Omega$ or 0Vdc, or 10V PWM signal with 0% duty cycle.

- ※ DALI Interface (primary side; for DA/DA2-Type)
 - Apply DALI signal between DA+ and DA-.
 - DALI protocol comprises 16 groups and 64 addresses.
 - First step is fixed at 0.2% of output

OUTPUT LOAD vs TEMPERATURE

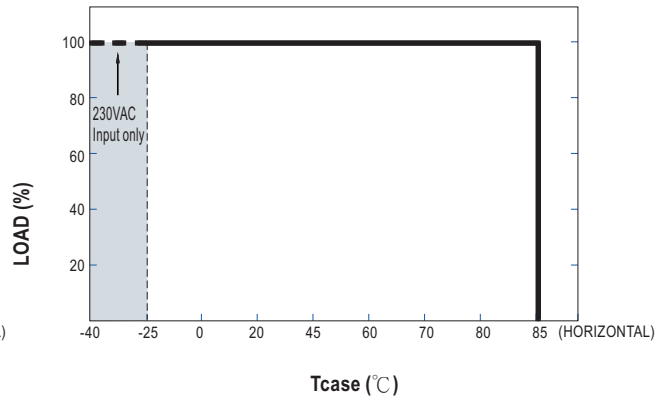
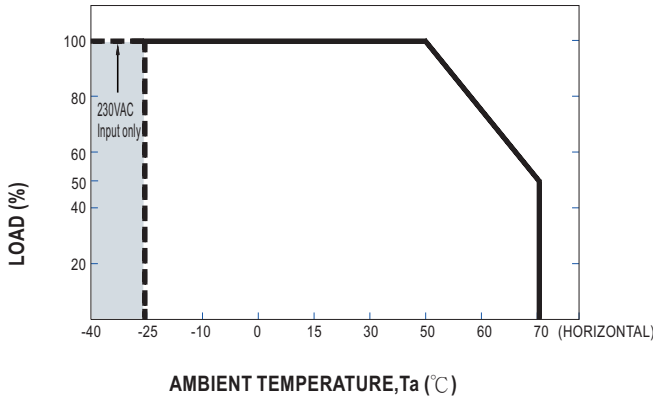

STATIC CHARACTERISTIC

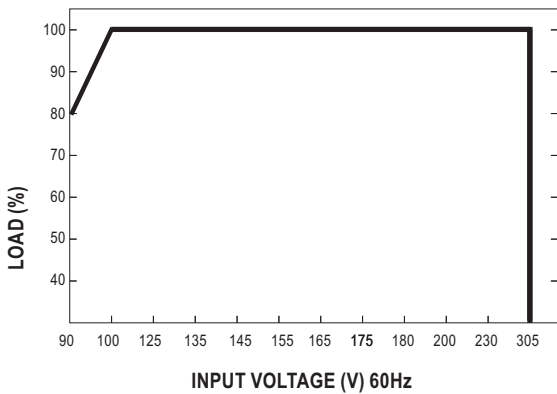

※ De-rating is needed under low input voltage.

POWER FACTOR (PF) CHARACTERISTIC

※ T_{case} at 75°C

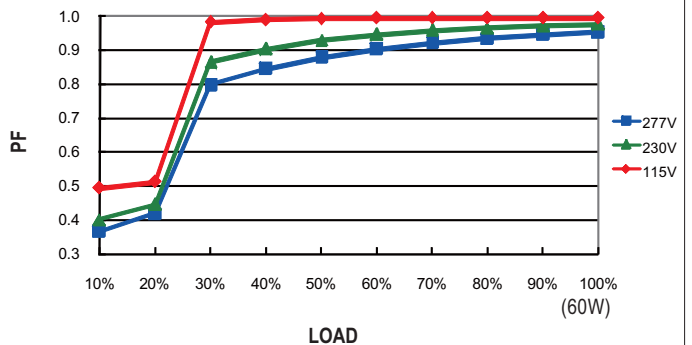

TOTAL HARMONIC DISTORTION (THD)

※ 48V Model, T_{case} at 75°C

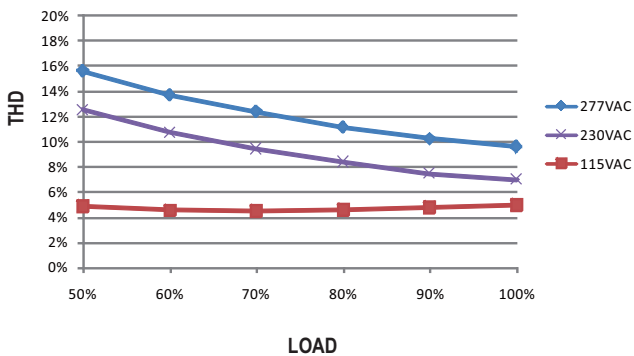

EFFICIENCY vs LOAD

PWM-60 series possess superior working efficiency that up to 90% can be reached in field applications.

※ 48V Model, T_{case} at 75°C

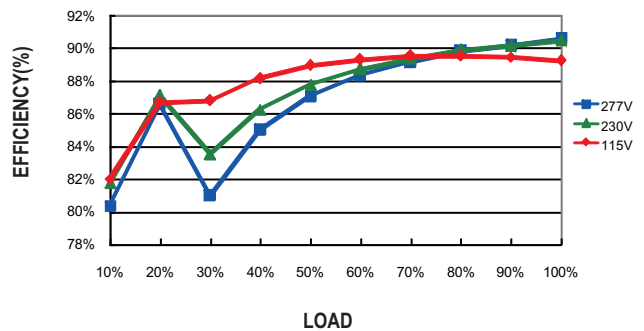

■ LIFE TIME

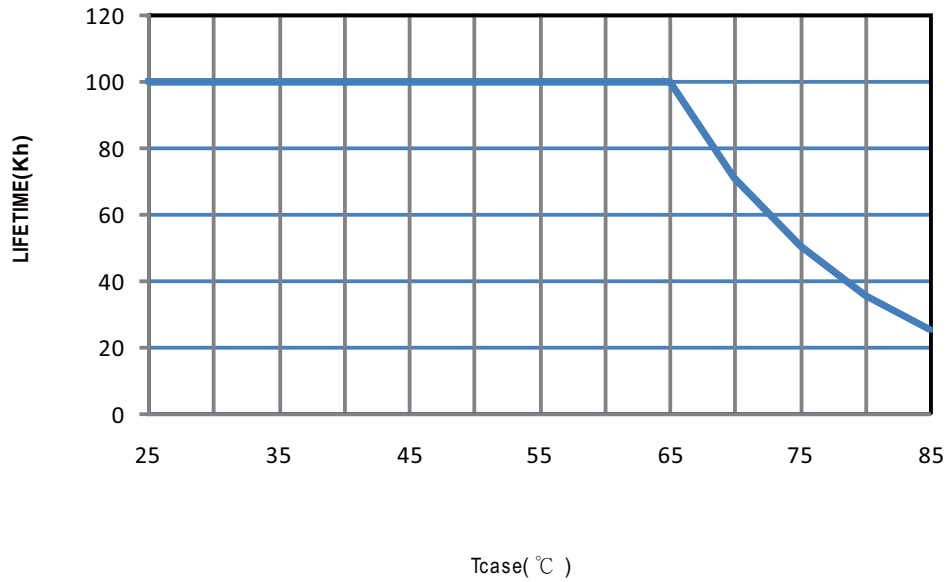

■ Block Diagram

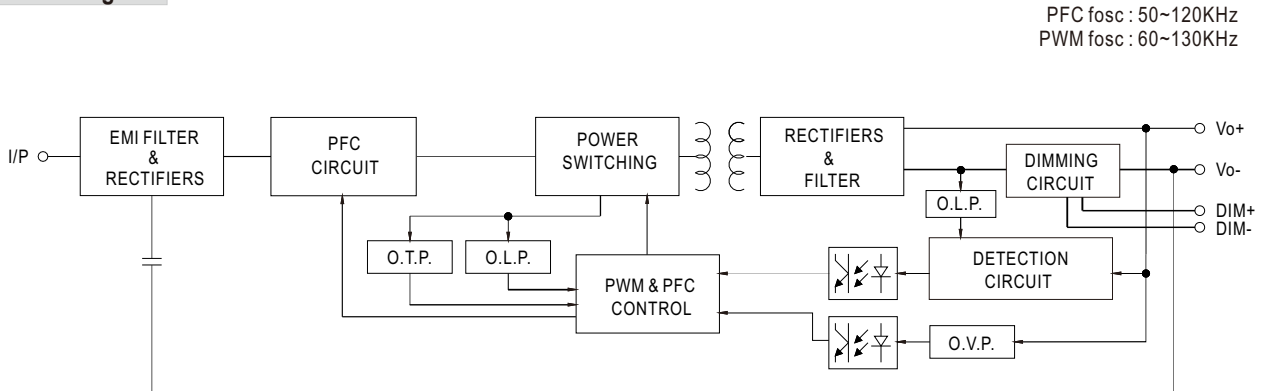

■ Mechanical Specification

Case No. NPF-60A Unit:mm

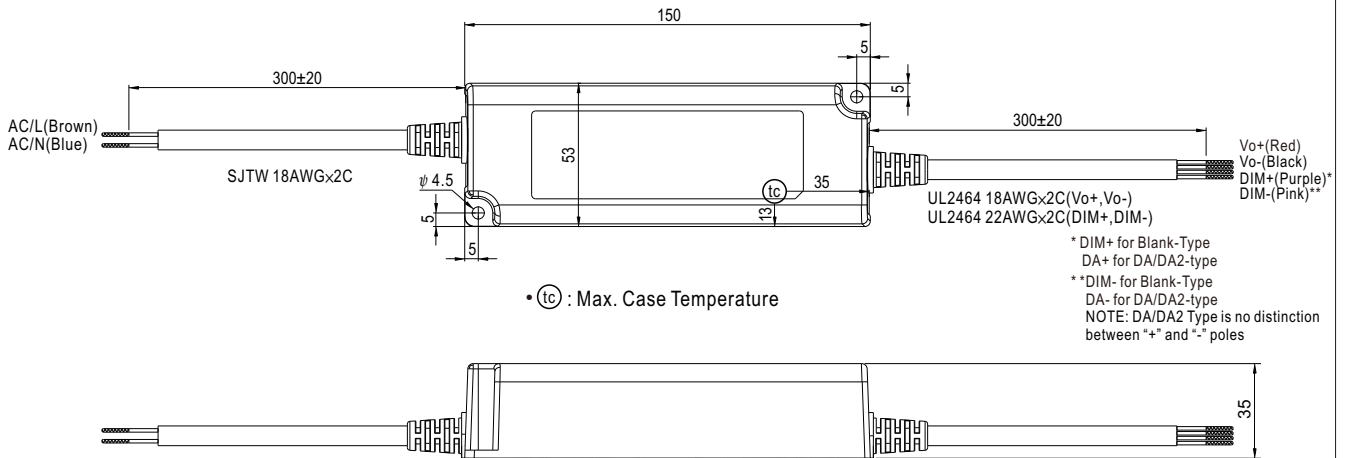

■ Recommend Mounting Direction

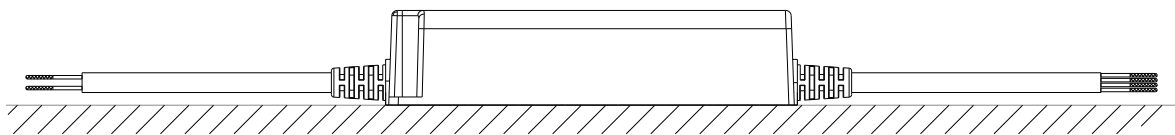

■ Installation Manual

◎ Connection for Blank-type

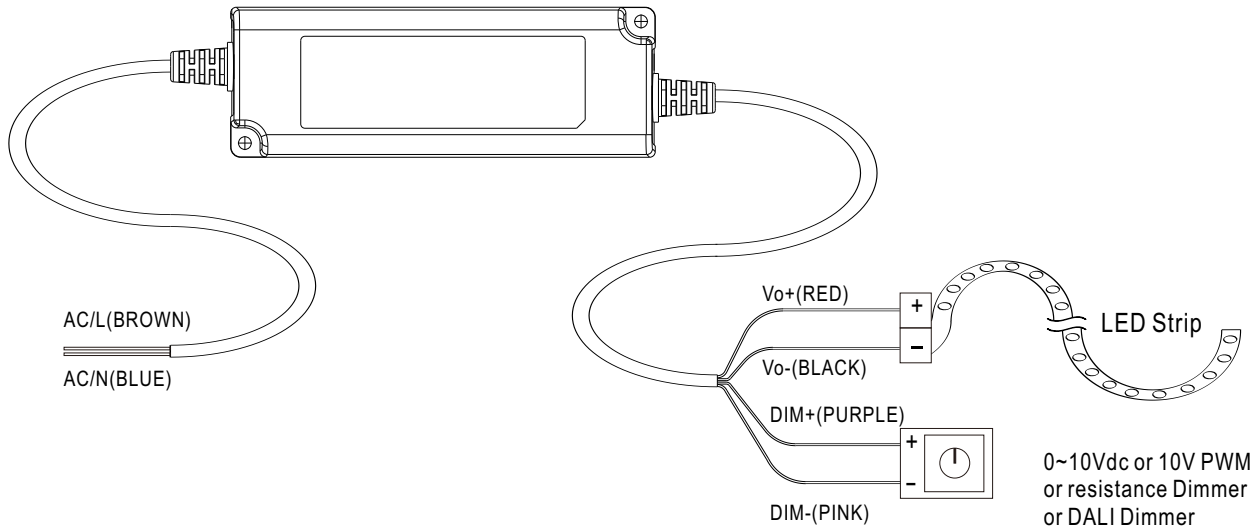

◎ Cautions

- Before commencing any installation or maintenance work, please disconnect the power supply from the utility. Ensure that it cannot be re-connected inadvertently!
- Keep proper ventilation around the unit and do not stack any object on it. Also a 10-15 cm clearance must be kept when the adjacent device is a heat source.
- Mounting orientations other than standard orientation or operate under high ambient temperature may increase the internal component temperature and will require a de-rating in output current.
- Current rating of an approved primary /secondary cable should be greater than or equal to that of the unit. Please refer to its specification.
- For LED drivers with waterproof connectors, verify that the linkage between the unit and the lighting fixture is tight so that water cannot intrude into the system.
- For dimmable LED drivers, make sure that your dimming controller is capable of driving these units. PWM series require 0.15mA each unit.
- Tc max. is identified on the product label. Please make sure that temperature of Tc point will not exceed limit.
- DO NOT connect "DIM- to Vo-".
- Suitable for indoor use or outdoor use without direct sunlight exposure. Please avoid immerse in the water over 30 minutes.
- The power supply is considered as a component that will be operated in combination with final equipment. Since EMC performance will be affected by the complete installation, the final equipment manufacturers must re-qualify EMC Directive on the complete installation again.