

## Data Sheet | Item Number: 890-665

T-distribution connector; 3-pole; Cod. A; 1 input; 2 outputs; 3 locking levers; for flying leads; white

<https://www.wago.com/890-665>



Color: ■ white

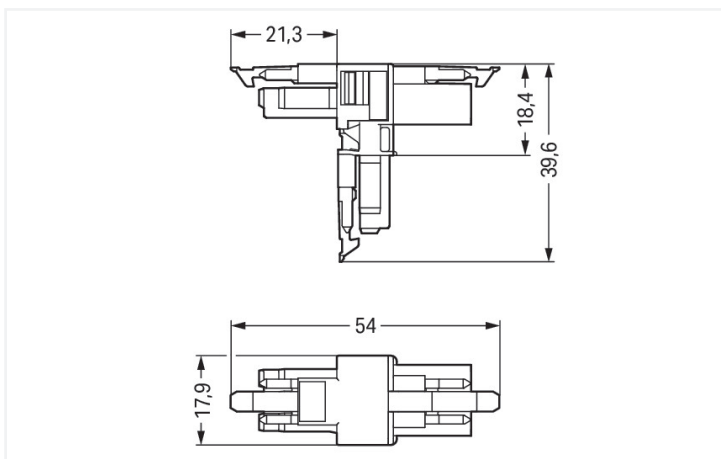

Dimensions in mm

Distribution connector *WINSTA*® MINI rated current 16 A

Use effective pluggable connections instead of laborious screw connections: With the *WINSTA*® MINI distribution connector A coding. Our pluggable installation connectors with spring pressure connection technology work completely without screw connections. They allow fast, efficient, error-free installation in numerous applications. The coding options reduce installation errors, allowing fast, maintenance-free wiring of all components. Thanks to the color coding and mechanical A coding of *WINSTA*® MINI pluggable installation connectors, you can clearly distinguish different circuits. Due to its particularly minimal dimensions, our *WINSTA*® MINI Pluggable Connection System with Push-in CAGE CLAMP® spring pressure connection technology is very suitable in very tight spaces, i.e., for connections when very little room is available.

Lower costs through fast commissioning and elimination of service expenses – solutions from *WINSTA*® MINI

*WINSTA*® is the pluggable connection system that is perfectly tailored to the strict requirements of electrical installation. It allows fast, secure and, above all, error-free installation of components and cables. Choose durability and quality – with locking lever from WAGO makes the electrical installation of electrical components significantly easier.

- effective protection against mismatching
- compact design for conductors with a cross-section up to 1.5 mm<sup>2</sup>
- for any mains application
- custom-engineered solutions
- quick replacement of defective units during ongoing operation

## Electrical data

Ratings per	IEC/EN 60664-1			Approvals per	UL 1977
Overvoltage category	III	III	II	Rated voltage	600 V
Pollution degree	3	2	2	Rated current	14 A
Nominal voltage	250 V	-	-		
Rated impulse withstand voltage	4 kV	-	-		
Rated current	16 A	-	-		

## General information

Note on contact resistance	approx. 1 mΩ of contact resistance approx. 0.25 mΩ contact transition plug/ socket
----------------------------	--

## Connection Data

Total number of potentials	3	<b>Connection 1</b>	
PE function	Preceding PE contact	Pole number	3

## Physical data

Pin spacing	4.4 mm / 0.173 inches
Width	17.9 mm / 0.705 inches
Height	39.6 mm / 1.559 inches
Depth	54 mm / 2.122 inches

## Mechanical data

Use	General mains applications
Coding	A
Variable coding	No
Marking	L ⊕ N
Potential marking	L ⊕ N
Mating force of a plug-in connection	Approx. 20 ... 70 N (depending on pole number)
Retention force of a plug-in connection	When locked: > 80 N
Unmating force of a plug-in connection	Unlocked: approx. 20 ... 70 N (depending on pole number)
Number of mating cycles	200, without resistive load
Type of distribution box	T-distribution connector
Protection type	IP20; IP40 when mated
Suitable	for flying leads

## Plug-in connection

Mismating protection	Yes
Note on mismating protection	All <i>WINSTA</i> ® components are 100% protected against mismating when: a.) plugging different numbers of poles b.) plugging while rotated 180 c.) plugging while laterally staggered d.) plugging one pole
Locking lever	Yes
Locking of plug-in connection	Locking lever
Note on locking system	All connectors for mounted installations (snap-in versions for lighting fixtures or devices, all types of PCB and distribution connectors) are factory-equipped with locking levers to ensure plugs and sockets are securely locked. Additional locking levers are only required for flying leads (plug/socket).
Number of locking levers	3

### Material data

Note (material data)	<a href="#">Information on material specifications can be found here</a>
Color	white
Material group	I
Insulation material (main housing)	Polyamide (PA66)
Flammability class per UL94	V0
Contact material	Copper or copper alloy; surface-treated
Contact Plating	Tin
Fire load	0.21 MJ
Weight	8.6 g

### Environmental requirements

Processing temperature	-5 ... +40 °C
Continuous operating temperature	-35 ... +85 °C
Note on continuous operating temperature	Insulating parts for temperatures ≤ 105 °C

### Commercial data

Product Group	20 (Winsta)
PU (SPU)	25 pcs
Packaging type	Box
Country of origin	DE
GTIN	4045454490515
Customs tariff number	85366990990

### Product Classification

UNSPSC	39121406
eCl@ss 10.0	27-44-06-03
eCl@ss 9.0	27-44-06-03
ETIM 9.0	EC002567
ETIM 10.0	EC002567
ECCN	NO US CLASSIFICATION

### Environmental Product Compliance

RoHS Compliance Status	Compliant, No Exemption
------------------------	-------------------------

### Approvals / Certificates

#### General approvals



Approval	Standard	Certificate Name
CCA DEKRA Certification B.V.	EN 61535	71-123231
CCA DEKRA Certification B.V.	IEC 61535	NL-85020
cURus Underwriters Laboratories Inc.	UL 1977	E45171

#### Declarations of conformity and manufacturer's declarations

Approval	Standard	Certificate Name
EU-Declaration of Confor- mity WAGO GmbH & Co. KG	-	-
UK-Declaration of Confor- mity WAGO GmbH & Co. KG	-	-

Approvals for marine applications



Approval	Standard	Certificate Name
ABS American Bureau of Ship- ping	Steel Vessel Rules	24-0095973-PDA
DNV GL Det Norske Veritas, Ger- manischer Lloyd	-	TAE00001Z6
LR Lloyds Register	EN 61535	LR23317167TA
PRS Polski Rejestr Statków	-	TE/1096/880590/23

Downloads

Environmental Product Compliance

Compliance Search
Environmental Product Compliance 890-665

Documentation

Bid Text			
890-665	19.02.2019	xml 2.83 KB	
890-665	30.11.2018	doc 22.50 KB	

CAD/CAE-Data

CAD data
2D/3D Models 890-665

CAE data
EPLAN Data Portal 890-665
WSCAD Universe 890-665

Installation Notes

Installation

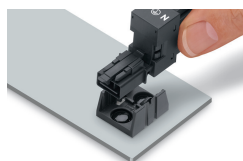

Secure the mounting plate via pins.

Subject to changes. Please also observe the further product documentation!

Current addresses can be found at: [www.wago.com](http://www.wago.com)