

## Overview

KEMET's C700 encapsulated radial leaded ceramic disc capacitors are specifically designed for interference-suppression AC line filtering applications. Having internationally recognized safety certifications, these capacitors are well-suited for applications that require keeping potentially disruptive or damaging line transients and EMI out of susceptible equipment. They are also an ideal solution when needing to suppress line disturbances at the source.

Safety Certified Capacitors are classified as either X and/or Y capacitors. Class X capacitors are primarily used in line-to-line (across-the-line) applications. In this application, there is no danger of electric shock to humans should the

capacitor fail, but could result in a risk of fire. The class Y capacitor is primarily used in line-to-ground (line by-pass) applications. In this application, failure of the capacitor could lead to danger of electric shock.

With a working voltage of 440/400 VAC in line-to-line (Class X) and 300/250 VAC in line-to-ground (Class Y) applications, these safety capacitors meet the impulse test criteria outlined in IEC Standard 60384. Meeting subclass X1 and Y2 requirements, these devices are certified to withstand impulses up to 4 KV (X1) and 5 KV (Y2) respectively. These encapsulated devices also meet the flame test requirements outlined in UL Standard 94 V-0.

## Benefits

- Safety standard recognized (IEC 60384-14)
- Reliable operation up to 125°C
- Class X1 440/400 VAC/Y2 300/250 VAC
- 5.0 mm, 7.5 mm, 10 mm, and 12.5mm lead spacing
- Lead(Pb)-free and RoHS Compliant
- Halogen-free
- Capacitance offerings ranging from 100 pF up to 10 nF
- Available capacitance tolerances of  $\pm 5\%$ ,  $\pm 10\%$ , and  $\pm 20\%$
- High-reliability
- Preformed (crimped) or straight lead configurations
- Non-polar device, minimizing installation concerns
- Encapsulation meets flammability standard UL 94 V-0

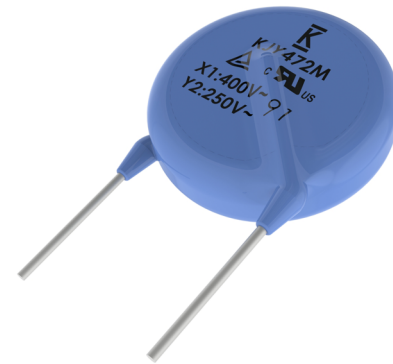

## Applications

Typical applications include:

- Line-to-line (Class X) filtering
- Line-to-ground (Class Y) filtering
- Antenna coupling
- Primary and secondary coupling (switching power supplies)
- Line disturbances suppression (motors and motor controls, relays, switching power supplies and invertors)

## Radial Leaded Ceramic Disc Capacitors

Safety Standard Recognized, C700, Encapsulated,  
KJY Type, X1 440/400 VAC/Y2 300/250 VAC (Industrial Grade)

### Ordering Information

C7	8	1	U	103	M	Y	V	D	A	A	7301
Ceramic Series	Body Diameter	Lead Spacing <sup>1,2,3</sup>	Spec.	Capacitance Code (pF)	Capacitance Tolerance	Rated Voltage	Dielectric/Temp. Char.	Design	Lead Configuration <sup>1,3</sup>	Failure Rate	Packaging (C-Spec)
C7 = Ceramic 700	0 = 7.0 mm 1 = 8.0 mm 2 = 9.0 mm 3 = 10.0 mm 4 = 11.0 mm 5 = 12.0mm 6 = 13.0 mm 7 = 14.0 mm 8 = 15.0 mm 9 = 16.0 mm	5 = 5.0 mm 7 = 7.5 mm 1 = 10.0 mm 2 = 12.5 mm	U = Safety	Two significant digits and Number of zeroes	K = ±10% M = ±20%	Y = X1 400 VAC/ Y2 250 VAC Z = X1 440 VAC/ Y2 300 VAC	S = SL Y = Y5P W = Y5U V = Y5V	D = Disc	A = Straight B = Vertical Kink C = Outside Kink D = Inside Kink	A = N/A	See "Packaging C-Spec Ordering Options Table" below

<sup>1</sup> Due to a high risk of arcing, "Inside Kink" lead configuration cannot be combined with the 5 mm lead spacing option. The "Inside Kink" option is only available on capacitors with lead spacing of 7.5 mm or greater. A potential for arcing may exist when combining the "Inside Kink" lead configuration with a 7.5 mm lead spacing option, especially in high humidity environments and/or when exposure to voltages and transients may impact creepage and clearance requirements.

<sup>2</sup> Capacitor body diameter will limit available lead spacing and packaging options. See "Dimensions" and "Product Ordering Codes and Ratings" sections of this document to determine availability.

<sup>3</sup> Bulk packaging lead length availability is dependent upon "Lead Configuration" and "Lead Spacing." See "Dimensions" section of this document to verify availability of a specific lead length option. For nonstandard lead length inquiries, please contact KEMET.

### Packaging C-Spec Ordering Options Table

Packaging Type	Lead Length (mm) <sup>2,3</sup>	Packaging Ordering Code (C-Spec)
Reel	See Note 2	7301
Ammo Pack		7317
Bulk Bag	3.5 ±1.0	WL35
	5.0 ±1.0	WL50
	25.0 mm Minimum	WL25

<sup>1</sup> For nonstandard lead length inquiries, please contact KEMET.

<sup>2</sup> Lead length for ammo and reel pack packaging is defined by the H and H0 dimensions in Table 3.

**Radial Leaded Ceramic Disc Capacitors**  
 Safety Standard Recognized, C700, Encapsulated,  
 KJY Type, X1 440/400 VAC/Y2 300/250 VAC (Industrial Grade)

**Lead Configurations**

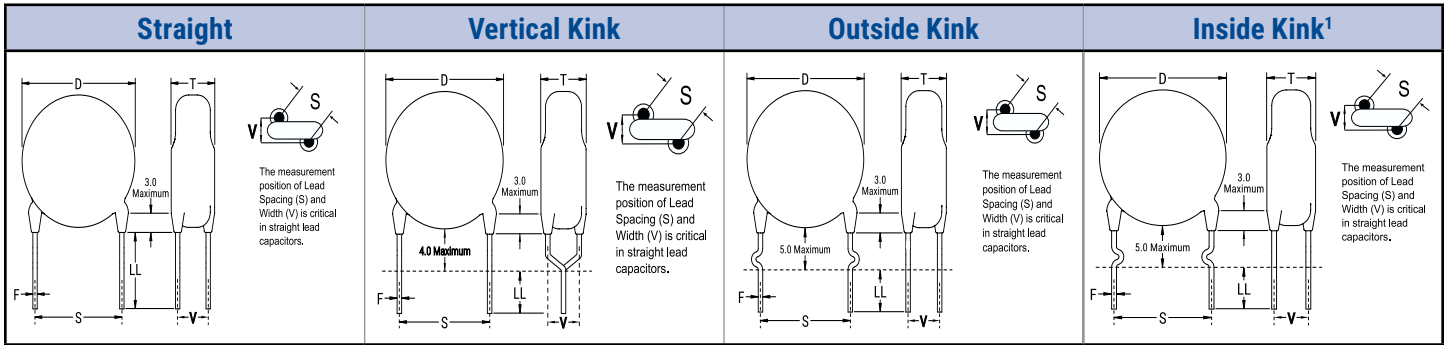

<sup>1</sup> Due to a high risk of arcing, the "Inside Kink" lead configuration option cannot be combined with 5 mm lead spacing ("S" dimension above). The "Inside Kink" option is only available on devices with lead spacing of 7.5 mm, 10 mm, or 12.5 mm.

**Dimensions – Millimeters**

Lead Configuration	Lead Configuration Ordering Code <sup>1</sup>	S	Lead Spacing Tolerance	D	T	V	F
		Lead Spacing <sup>2</sup>		Body Diameter <sup>2</sup>	Body Thickness	Width	Lead Diameter
Straight	A	5.0	±1.0	See Table 1 - "Product Ordering Codes and Ratings"		2.1 ± 0.5	0.60 ± 0.1
		7.5					
		10.0					
		12.5					
Vertical Kink (Preformed)	B	5.0					
		7.5					
		10.0					
		12.5					
Outside Kink (Preformed)	C	5.0					
		7.5					
		10.0					
		12.5					
Inside Kink (Preformed)	D	7.5					
		10.0					
		12.5					

<sup>1</sup> Lead Configuration is identified in the 13th character of the ordering code. See "Lead Configuration" and "Ordering Information" sections of this document for further details.

<sup>2</sup> Body diameter of capacitor will limit available lead spacing and packaging options. See "Product Ordering Codes and Ratings" sections of this document for further details.

**Radial Leaded Ceramic Disc Capacitors**  
 Safety Standard Recognized, C700, Encapsulated,  
 KJY Type, X1 440/400 VAC/Y2 300/250 VAC (Industrial Grade)

**Approval Standard and Certification No.**

Safety Standard	Standard No.	Subclass	Working Voltage	Certificate No.
TUV	IEC 60384-14	X1	400 VAC	<a href="#">R50466992</a>
		Y2	250 VAC	
TUV	IEC 60384-14	X1	440 VAC	<a href="#">R50466992</a>
		Y2	300 VAC	
UL CAN/CSA	UL 60384-14 and E60384-14	X1	400 VAC	<a href="#">E356389</a>
		Y2	250 VAC	
UL CAN/CSA	UL 60384-14 and E60384-14	X1	440 VAC	<a href="#">E356389</a>
		Y2	300 VAC	

These devices are TUV and UL recognized for antenna coupling and AC line-to-line (Class X) and line-to-ground (Class Y) applications per IEC60384-14 and UL 60384-14.

**Environmental Compliance**

These devices are Halogen-free and RoHS Compliant. They meet all requirements set forth by both EU and China RoHS directives.



# Radial Leaded Ceramic Disc Capacitors

Safety Standard Recognized, C700, Encapsulated,  
KJY Type, X1 440/400 VAC/Y2 300/250 VAC (Industrial Grade)

## Table 1A – X1 400 Y2 250 Product Ordering Codes and Ratings

Dielectric/ Temp. Char.	KEMET Part Number	Capacitance	Capacitance Tolerance	Dimensions (mm)			Lead Spacing
				Body Diameter (Maximum)	Body Thickness (Maximum)	Lead Diameter	
Y5P	C71(1)U101KYYD(2)A(3)	100 pF	±10%	8.0	9.0	0.60 ± 0.1	10.0 mm ± 1.0 12.5 mm ± 1.0
	C71(1)U151KYYD(2)A(3)	150 pF					
	C71(1)U181KYYD(2)A(3)	180 pF					
	C71(1)U221KYYD(2)A(3)	220 pF					
	C71(1)U331KYYD(2)A(3)	330 pF		10.0			
	C71(1)U471KYYD(2)A(3)	470 pF					
	C72(1)U561KYYD(2)A(3)	560 pF					
	C72(1)U681KYYD(2)A(3)	680 pF					
C73(1)U102KYYD(2)A(3)	1000 pF						
Y5U	C71(1)U102MYWD(2)A(3)	1000 pF	±20%	8.0	5.0	0.60 ± 0.1	10.0 mm ± 1.0 12.5 mm ± 1.0
	C72(1)U152MYWD(2)A(3)	1500 pF		9.0			
	C73(1)U222MYWD(2)A(3)	2200 pF		10.0			
	C74(1)U252MYWD(2)A(3)	2500 pF		11.0			
	C75(1)U332MYWD(2)A(3)	3300 pF		12.0			
	C76(1)U392MYWD(2)A(3)	3900 pF		13.0			
	C77(1)U472MYWD(2)A(3)	4700 pF		14.0			
Y5V	C71(1)U102MYVD(2)A(3)	1000 pF	±20%	8.0	5.0	0.60 ± 0.1	10.0 mm ± 1.0 12.5 mm ± 1.0
	C71(1)U152MYVD(2)A(3)	1500 pF		9.0			
	C72(1)U222MYVD(2)A(3)	2200 pF		10.0			
	C73(1)U252MYVD(2)A(3)	2500 pF					
	C73(1)U332MYVD(2)A(3)	3300 pF		11.0			
	C74(1)U392MYVD(2)A(3)	3900 pF					
	C75(1)U472MYVD(2)A(3)	4700 pF		12.0			
	C76(1)U502MYVD(2)A(3)	5000 pF		13.5			
	C77(1)U562MYVD(2)A(3)	5600 pF		14.0			
	C78(1)U682MYVD(2)A(3)	6800 pF		15.0			
	C79(1)U103MYVD(2)A(3)	10000 pF		16.0			
Dielectric/ Temp. Char.	KEMET Part Number	Capacitance	Capacitance Tolerance	Body Diameter (Maximum)	Body Thickness (Maximum)	Lead Diameter	Lead Spacing

(1) To properly complete ordering code, insert the one-digit numeric code to reflect required lead spacing: (Note that select capacitance values and packaging options may limit lead spacing availability. See table above to verify availability.)

- 5 = 5.0 mm
- 7 = 7.5 mm
- 1 = 10.0 mm
- 2 = 12.5 mm

(2) To properly complete ordering code, insert the one-digit character code to reflect the required lead configuration: (See "Lead Configuration" section of this document, page 2, for further details.)

- A = Straight
- B = Vertical Kink
- C = Outside Kink
- D = Inside Kink

(3) To properly complete ordering code, enter the four-digit numeric or alphanumeric "Packaging C-Spec Ordering Code." See "Dimensions" section of this document, page 2, for available options.

# Radial Leaded Ceramic Disc Capacitors

Safety Standard Recognized, C700, Encapsulated,  
KJY Type, X1 440/400 VAC/Y2 300/250 VAC (Industrial Grade)

## Table 1B – X1 440 Y2 300 Product Ordering Codes and Ratings

Dielectric/ Temp. Char.	KEMET Part Number	Capacitance	Capacitance Tolerance	Dimensions (mm)			Lead Spacing
				Body Diameter (Maximum)	Body Thickness (Maximum)	Lead Diameter	
Y5P	C71(1)U101KZYD(2)A(3)	100 pF	±10%	8.0	5.0	0.60 ± 0.1	10.0 mm ± 1.0 12.5 mm ± 1.0
	C71(1)U151KZYD(2)A(3)	150 pF					
	C71(1)U181KZYD(2)A(3)	180 pF					
	C71(1)U221KZYD(2)A(3)	220 pF					
	C71(1)U331KZYD(2)A(3)	330 pF		9.0			
	C71(1)U471KZYD(2)A(3)	470 pF					
	C72(1)U561KZYD(2)A(3)	560 pF					
	C72(1)U681KZYD(2)A(3)	680 pF					
C73(1)U102KZYD(2)A(3)	1000 pF	10.0					
Y5U	C71(1)U102MZWD(2)A(3)	1000 pF	±20%	8.0	5.0	0.60 ± 0.1	10.0 mm ± 1.0 12.5 mm ± 1.0
	C72(1)U152MZWD(2)A(3)	1500 pF		9.0			
	C73(1)U222MZWD(2)A(3)	2200 pF		10.0			
	C74(1)U252MZWD(2)A(3)	2500 pF		11.0			
	C75(1)U332MZWD(2)A(3)	3300 pF		12.0			
	C76(1)U392MZWD(2)A(3)	3900 pF		13.0			
	C77(1)U472MZWD(2)A(3)	4700 pF		14.0			
	Y5V	C71(1)U102MZVD(2)A(3)		1000 pF			
C71(1)U152MZVD(2)A(3)		1500 pF	9.0				
C72(1)U222MZVD(2)A(3)		2200 pF	10.0				
C73(1)U252MZVD(2)A(3)		2500 pF					
C73(1)U332MZVD(2)A(3)		3300 pF					
C74(1)U392MZVD(2)A(3)		3900 pF	11.0				
C75(1)U472MZVD(2)A(3)		4700 pF	12.0				
C76(1)U502MZVD(2)A(3)		5000 pF	13.5				
C77(1)U562MZVD(2)A(3)		5600 pF	14.0				
C78(1)U682MZVD(2)A(3)		6800 pF	15.0				
C79(1)U103MZVD(2)A(3)		10000 pF	16.0				
<b>Dielectric/ Temp. Char.</b>	<b>KEMET Part Number</b>	<b>Capacitance</b>	<b>Capacitance Tolerance</b>	<b>Body Diameter (Maximum)</b>	<b>Body Thickness (Maximum)</b>	<b>Lead Diameter</b>	<b>Lead Spacing</b>

(1) To properly complete ordering code, insert the one-digit numeric code to reflect required lead spacing: (Note that select capacitance values and packaging options may limit lead spacing availability. See table above to verify availability.)

- 7 = 7.5mm
- 1 = 10.0 mm
- 2 = 12.5 mm

(2) To properly complete ordering code, insert the one-digit character code to reflect the required lead configuration: (See "Lead Configuration" section of this document, page 2, for further details.)

- A = Straight
- B = Vertical Kink
- C = Outside Kink
- D = Inside Kink

(3) To properly complete ordering code, enter the four-digit numeric or alphanumeric "Packaging C-Spec Ordering Code." See "Dimensions" section of this document, page 2, for available options.

**Radial Leaded Ceramic Disc Capacitors**  
 Safety Standard Recognized, C700, Encapsulated,  
 KJY Type, X1 440/400 VAC/Y2 300/250 VAC (Industrial Grade)

**Table 2 – Performance & Reliability: Test Methods and Conditions**

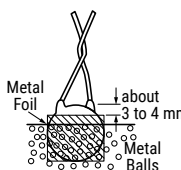
Item		Specification	Test Method																						
Operating Temperature Range		-55°C to +125°C																							
Dielectric Strength	Between lead wires	No failures	The capacitor shall not be damaged when 2,600 VAC (rms) is applied between the lead wires for 60 seconds.																						
	Body Insulation	No failures	<p>The terminals (leads) of the capacitor shall be connected together. A metal foil is tightly wrapped around the body of the capacitor at a distance of about 3 to 4 mm from each terminal. The capacitor is then inserted into a container filled with metal balls approximately 1 mm in diameter. 2,600 VAC (rms) is applied for 60 seconds between the capacitor lead wires and metal balls. (charge/discharge current ≤ 50 mA).</p> 																						
Insulation Resistance (IR)		10,000 MΩ minimum	The insulation resistance shall be measured with 500 ±50 VDC applied after 60 ±5 seconds of charging.																						
Capacitance		Within specified tolerance																							
Dissipation Factor (DF) or Q	<table border="1"> <thead> <tr> <th>Temperature Characteristics</th> <th>Specification</th> </tr> </thead> <tbody> <tr> <td>Y5P</td> <td>DF ≤ 2.5%</td> </tr> <tr> <td>Y5U/Y5V</td> <td>DF ≤ 5.0%</td> </tr> <tr> <td>SL</td> <td>Q ≥ 300</td> </tr> </tbody> </table>		Temperature Characteristics	Specification	Y5P	DF ≤ 2.5%	Y5U/Y5V	DF ≤ 5.0%	SL	Q ≥ 300	<table border="1"> <thead> <tr> <th>Characteristic</th> <th>Frequency</th> <th>Voltage</th> </tr> </thead> <tbody> <tr> <td>SL</td> <td>1 MHz ±20%</td> <td rowspan="2">5.0 V<sub>rms</sub> Maximum</td> </tr> <tr> <td>Y5P /Y5U/Y5V</td> <td>1 kHz ±20%</td> </tr> <tr> <td colspan="3">The measurement at reference temperature 25°C</td> </tr> </tbody> </table>	Characteristic	Frequency	Voltage	SL	1 MHz ±20%	5.0 V <sub>rms</sub> Maximum	Y5P /Y5U/Y5V	1 kHz ±20%	The measurement at reference temperature 25°C					
	Temperature Characteristics	Specification																							
	Y5P	DF ≤ 2.5%																							
	Y5U/Y5V	DF ≤ 5.0%																							
SL	Q ≥ 300																								
Characteristic	Frequency	Voltage																							
SL	1 MHz ±20%	5.0 V <sub>rms</sub> Maximum																							
Y5P /Y5U/Y5V	1 kHz ±20%																								
The measurement at reference temperature 25°C																									
Temperature Characteristics	<table border="1"> <thead> <tr> <th>Temperature Characteristics</th> <th>Capacitance Change</th> </tr> </thead> <tbody> <tr> <td>Y5P</td> <td>Within ±10%</td> </tr> <tr> <td>Y5U</td> <td>Within +22%/-56%</td> </tr> <tr> <td>Y5V</td> <td>Within +22%/-82%</td> </tr> <tr> <td>SL</td> <td>+350~1,000%</td> </tr> </tbody> </table>		Temperature Characteristics	Capacitance Change	Y5P	Within ±10%	Y5U	Within +22%/-56%	Y5V	Within +22%/-82%	SL	+350~1,000%	<p>A capacitance measurement is made at each step specified:</p> <table border="1"> <thead> <tr> <th>Step</th> <th>Temperature</th> </tr> </thead> <tbody> <tr> <td>1</td> <td>+25 ±2°C</td> </tr> <tr> <td>2</td> <td>Minimum operating temperature</td> </tr> <tr> <td>3</td> <td>+25 ±2°C</td> </tr> <tr> <td>4</td> <td>Maximum operating temperature</td> </tr> <tr> <td>5</td> <td>+25 ±2°C</td> </tr> </tbody> </table>	Step	Temperature	1	+25 ±2°C	2	Minimum operating temperature	3	+25 ±2°C	4	Maximum operating temperature	5	+25 ±2°C
	Temperature Characteristics	Capacitance Change																							
	Y5P	Within ±10%																							
	Y5U	Within +22%/-56%																							
	Y5V	Within +22%/-82%																							
SL	+350~1,000%																								
Step	Temperature																								
1	+25 ±2°C																								
2	Minimum operating temperature																								
3	+25 ±2°C																								
4	Maximum operating temperature																								
5	+25 ±2°C																								
Terminal Strength	Tensile	Lead wire or capacitor body shall not break.	With the termination in its normal position, the specimen is held by its body in such a manner that the axis of the termination is vertical. A tensile force of 10 N is applied to the termination in the direction of its axis and acting in a direction away from the body of the specimen.																						
	Bending	Lead wire or capacitor body shall not break.	With the termination in its normal position, the specimen is held by its body in such a manner that the axis of the termination is vertical; a mass force of 5 N is then suspended from the end of the termination. The body of the specimen is then inclined within a period of 2 to 3 seconds, through an angle of approximately 90° in the vertical plane and then resumed to its initial position over the same period of time; this operation constitutes one bend. One bend immediately followed by a second bend in the opposite direction.																						

<sup>1</sup> "Room Condition" is defined as follows: Temperature: 20 ~ 35°C/Humidity: 45 ~ 75%/Atmospheric Pressure: 86 ~ 106 kPa.

**Radial Leaded Ceramic Disc Capacitors**  
 Safety Standard Recognized, C700, Encapsulated,  
 KJY Type, X1 440/400 VAC/Y2 300/250 VAC (Industrial Grade)

**Table 2 – Performance & Reliability: Test Methods and Conditions cont.**

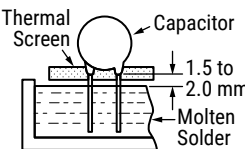
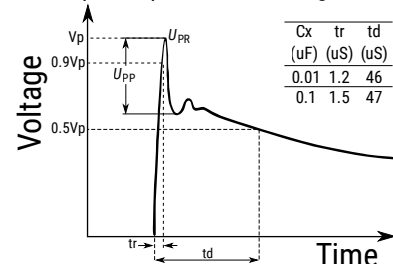
Item		Specification		Test Method											
Soldering Effect (Non-Preheat)	Appearance	No visual defect		As shown in the figure below, the lead wires are immersed in molten solder up to 1.5 mm (+5/-0 mm) from the end of the epoxy meniscus (root of lead wire). Duration/Solder Temperature: 3.5 ±0.5 seconds/350°C ±10°C or 10 ±1 seconds/260°C ±5°C 											
	IR	1,000 MΩ Minimum													
	Dielectric Strength	Per item 1													
	Capacitance	Within ±10%  Y5P, Y5U and Y5V: within ±10%  SL: within ±2.5% or ±0.25 pF, whichever is larger													
Biased Humidity	Appearance	No visual defect		Steady State Humidity:	Load Humidity:										
	Capacitance	<table border="1"> <thead> <tr> <th>Temperature Characteristics</th> <th>Capacitance Change</th> </tr> </thead> <tbody> <tr> <td>Y5P</td> <td>Within ±10%</td> </tr> <tr> <td>Y5U</td> <td>Within ±15%</td> </tr> <tr> <td>Y5V</td> <td>Within ±30%</td> </tr> <tr> <td>SL</td> <td>Within ±5%</td> </tr> </tbody> </table>		Temperature Characteristics	Capacitance Change	Y5P	Within ±10%	Y5U	Within ±15%	Y5V	Within ±30%	SL	Within ±5%	90 to 95% humidity at 40°C ±2°C for 500 ±12 hours.	90 to 95% humidity at 40°C ±2°C for 500 ±12 hours with full rated voltage applied.
		Temperature Characteristics	Capacitance Change												
		Y5P	Within ±10%												
		Y5U	Within ±15%												
	Y5V	Within ±30%													
	SL	Within ±5%													
	DF	Y5V and Y5U: 7.5% maximum Y5P: 5% maximum		<b>Post-treatment:</b> Capacitor is stored for 1 to 2 hours at room condition <sup>1</sup> .											
Q	Q ≥ 135														
IR	3,000 MΩ minimum														
Dielectric Strength	No failures		<b>Post-treatment:</b> Capacitor is stored for 1 to 2 hours at room condition <sup>1</sup> .												
Dielectric Strength	No failures														
High Temperature Life	Appearance	No visual defect		Impulse Voltage: Each individual capacitor is subjected to three 5 kv impulses prior to life testing.  <table border="1"> <thead> <tr> <th>Cx (uF)</th> <th>tr (uS)</th> <th>td (uS)</th> </tr> </thead> <tbody> <tr> <td>0.01</td> <td>1.2</td> <td>46</td> </tr> <tr> <td>0.1</td> <td>1.5</td> <td>47</td> </tr> </tbody> </table>		Cx (uF)	tr (uS)	td (uS)	0.01	1.2	46	0.1	1.5	47	
	Cx (uF)	tr (uS)	td (uS)												
	0.01	1.2	46												
	0.1	1.5	47												
Capacitance Change	Y5P, Y5U within ±20% Y5V within ±30%														
IR	3,000 MΩ minimum SL: 1,000 MΩ minimum														
Dielectric Strength	No failures		Capacitors are placed in a circulating air oven for a period of 1,000 hours. The air in the oven is maintained at a temperature of 125°C ±2 throughout the test. The capacitors are subjected to 170% of Rated Voltage. Each hour the voltage is increased to AC 1,000 V <sub>rms</sub> for 0.1 seconds.												

<sup>1</sup> "Room Condition" is defined as follows: Temperature: 20 ~ 35°C/Humidity: 45 ~ 75%/Atmospheric Pressure: 86 ~ 106 kPa.

**Table 2 – Performance & Reliability: Test Methods and Conditions cont.**

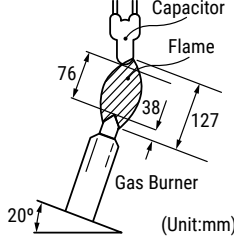
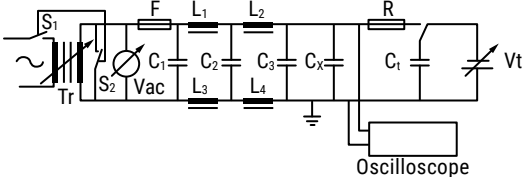
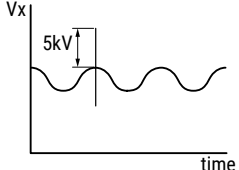
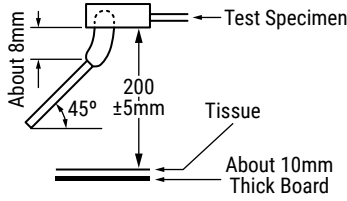
Item	Specification	Test Method																				
Flame Test	The capacitor flame extinguishes as follows: <table border="1" data-bbox="456 447 805 636"> <thead> <tr> <th>Cycle</th> <th>Time</th> </tr> </thead> <tbody> <tr> <td>1 ~ 4</td> <td>30 seconds maximum</td> </tr> <tr> <td>5</td> <td>60 seconds maximum</td> </tr> </tbody> </table>	Cycle	Time	1 ~ 4	30 seconds maximum	5	60 seconds maximum	The capacitor is exposed to a flame for 15 seconds and then removed for 15 seconds. This test is repeated for 5 cycles. 														
Cycle	Time																					
1 ~ 4	30 seconds maximum																					
5	60 seconds maximum																					
Active Flammability	The cheesecloth should not ignite.	The capacitors are individually wrapped in at least one, but not more than two, complete layers of cheesecloth. They are then subjected to 20 discharges. The interval between successive discharges is 5 seconds. The VAC is maintained for 2 minutes after the last discharge.  <table border="1" data-bbox="852 997 1518 1192"> <tbody> <tr> <td>C<sub>1,2</sub></td> <td>1 μF ±10%</td> <td>C<sub>3</sub></td> <td>0.033 μF ±5% 10 kV</td> </tr> <tr> <td>L<sub>1-10</sub></td> <td>1.5 mH ±20% 16 A Rod core choke</td> <td>C<sub>x</sub></td> <td>Test capacitor</td> </tr> <tr> <td>R</td> <td>100 ±2% Ω</td> <td>V<sub>AC</sub></td> <td>V<sub>R</sub> ±5%</td> </tr> <tr> <td>C<sub>t</sub></td> <td>3 μF ±5% 10 kV</td> <td>V<sub>R</sub></td> <td>Rated Working Voltage</td> </tr> <tr> <td>F</td> <td>Fuse, Rated 10A</td> <td>V<sub>t</sub></td> <td>Voltage applied to C<sub>t</sub></td> </tr> </tbody> </table> 	C <sub>1,2</sub>	1 μF ±10%	C <sub>3</sub>	0.033 μF ±5% 10 kV	L <sub>1-10</sub>	1.5 mH ±20% 16 A Rod core choke	C <sub>x</sub>	Test capacitor	R	100 ±2% Ω	V <sub>AC</sub>	V <sub>R</sub> ±5%	C <sub>t</sub>	3 μF ±5% 10 kV	V <sub>R</sub>	Rated Working Voltage	F	Fuse, Rated 10A	V <sub>t</sub>	Voltage applied to C <sub>t</sub>
C <sub>1,2</sub>	1 μF ±10%	C <sub>3</sub>	0.033 μF ±5% 10 kV																			
L <sub>1-10</sub>	1.5 mH ±20% 16 A Rod core choke	C <sub>x</sub>	Test capacitor																			
R	100 ±2% Ω	V <sub>AC</sub>	V <sub>R</sub> ±5%																			
C <sub>t</sub>	3 μF ±5% 10 kV	V <sub>R</sub>	Rated Working Voltage																			
F	Fuse, Rated 10A	V <sub>t</sub>	Voltage applied to C <sub>t</sub>																			
Passive Flammability	The burning time should not exceed 30 seconds. The tissue paper should not ignite.	The capacitor under test is held into a flame and in a position which best promotes burning. Each specimen is exposed to the flame once.  <p>Time of Exposure to Flame: 30 seconds                      Length of Flame: 12 ±1 mm                      Gas Burner Length: 35 mm minimum                      Inside Diameter: 0.5 ±0.1 mm                      Outside Diameter: 0.9 mm maximum                      Gas Butane Gas Purity: 95% minimum</p>																				

<sup>1</sup> "Room Condition" is defined as follows: Temperature: 20 ~ 35°C/Humidity: 45 ~ 75%/Atmospheric Pressure: 86 ~ 106 kPa.

## Radial Leaded Ceramic Disc Capacitors

Safety Standard Recognized, C700, Encapsulated,  
KJY Type, X1 440/400 VAC/Y2 300/250 VAC (Industrial Grade)

### Soldering and Mounting Information

#### Soldering:

When soldering this product to a PCB/PWB, do not exceed the solder heat resistance specification of the capacitor. Subjecting this product to excessive heating could reflow the solder joint between the lead and ceramic element and/or may result in thermal shocks that can crack the ceramic element.

When soldering these capacitors with a soldering iron, it should be performed under the following conditions:

- Temperature of iron-tip: 400°C maximum
- Soldering iron wattage: 50 W maximum
- Soldering time: 3.5 seconds maximum

#### Cleaning (ultrasonic cleaning):

To perform ultrasonic cleaning, observe the following conditions:

- Rinse bath capacity: output of 20 watts per liter or less
- Rinsing time: 5 minute maximum
- Do not vibrate the PCB/PWB directly
- Excessive ultrasonic cleaning may lead to fatigue destruction of the lead wires

### Construction

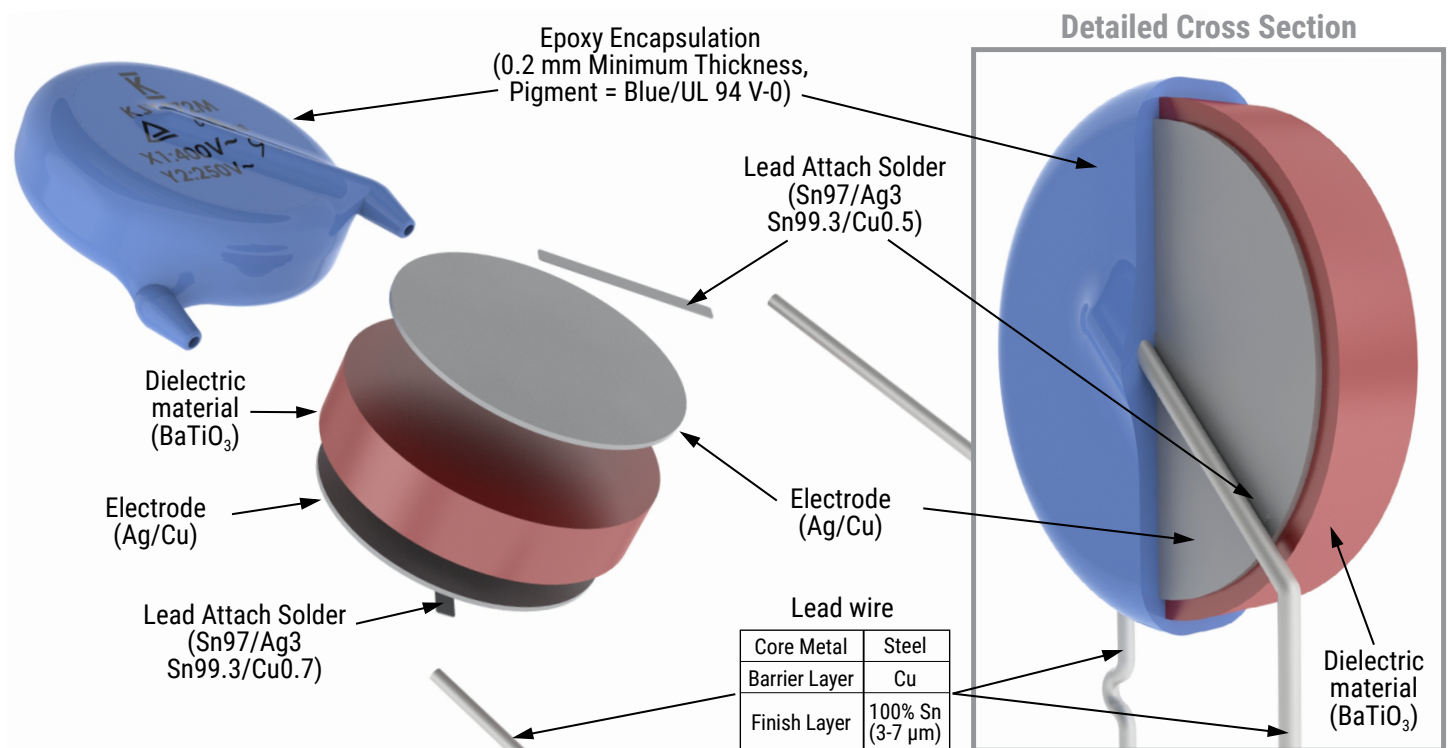

## Radial Leaded Ceramic Disc Capacitors

Safety Standard Recognized, C700, Encapsulated,  
KJY Type, X1 440/400 VAC/Y2 300/250 VAC (Industrial Grade)

### Marking

These capacitors shall be laser marked with KEMET's trademark, type designation, capacitor class, rated voltage, rated capacitance, and capacitance tolerance codes. In addition, all devices are marked with the recognized approval mark and a date/lot code for traceability. Marking will be supplied on one side of the encapsulated capacitor body. All marking shall be legible to allow for clear identification of the component. Marking appears in legible contrast. Illustrated below is an example of the marking format and content.

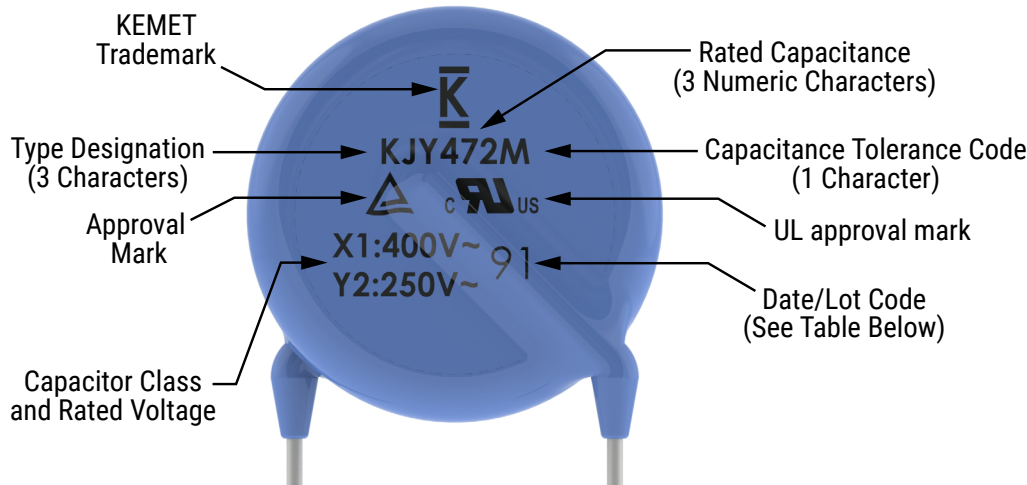

Date/Lot Code e.g., 9D (December 2019, Taiwan)

9	D	-
Last digit of year, e.g., 3 = 2013	Manufacturing Month: 1-9 = Jan - Sept O = October N = November D = December	Manufacturing Location Code  (blank): Taiwan C: Dongguan

## Radial Leaded Ceramic Disc Capacitors

Safety Standard Recognized, C700, Encapsulated,  
KJY Type, X1 440/400 VAC/Y2 300/250 VAC (Industrial Grade)

### Packaging Quantities

#### Ammo Pack (7317)

Lead Spacing	Body Diameter (mm)	Pitch (Carrier Tape)	Ammo Pack (Pieces/Box)
5	≤12	12.7	1000
	13≤D≤14	25.4	1000
	≥15	25.4	750
7.5	≤12	12.7	1,000
	13≤D≤14	25.4	1000
	≥15	25.4	750
10	≤10	25.4	1000
	≥11	25.4	750
12.5	≤10	25.4	1000
	≥11	25.4	750

#### Reel (7301)

Lead Spacing	Body Diameter (mm)	Pitch (Carrier Tape)	Ammo Pack (Pieces/Box)
5	<10	12.7	2000
	10≤D≤12	25.4	1000
	13≤D≤14	25.4	750
	≥15	12.7	2000
7.5	≤12	25.4	1000
	13≤D≤14	12.7	2000
	≥15	12.7	2000
10	≤10	25.4	1000
	≥11	25.4	750
12.5	≤10	25.4	1000
	≥11	25.4	750

#### Bulk Bag (Loose)

Body Diameter (mm)	Lead Length (WL25)	Cut Lead Length (WL35, WL50, WL10)
7	200 Pieces/Bag	500 Pieces/Bag
8		
9		
10		
11		
12		
13		
14		
15		
16		

**Radial Leaded Ceramic Disc Capacitors**  
 Safety Standard Recognized, C700, Encapsulated,  
 KJY Type, X1 440/400 VAC/Y2 300/250 VAC (Industrial Grade)

**Figure 1 - Ammo/Reel Pack Taping Format**

**5 mm and 7.5 mm Lead Spacing:**

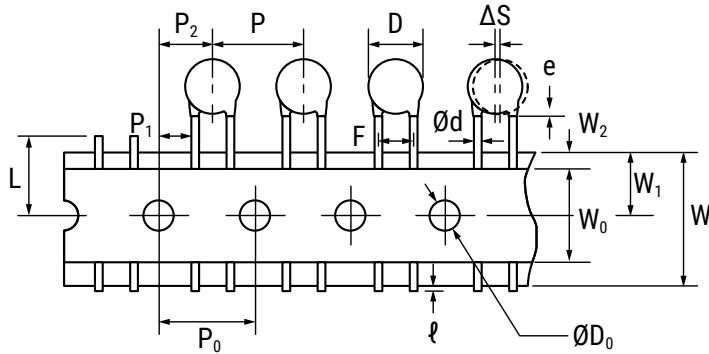

**5 mm, 7.5 mm, 10 mm and 12.5 mm Lead Spacing:**

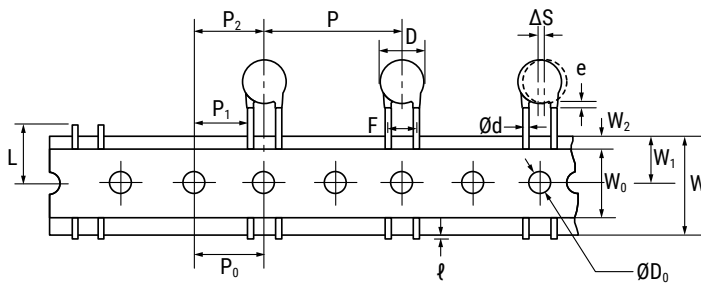

**For All Lead Spacing:**

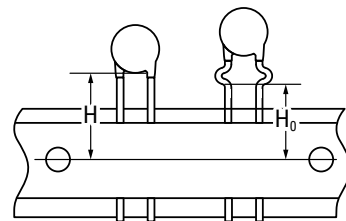
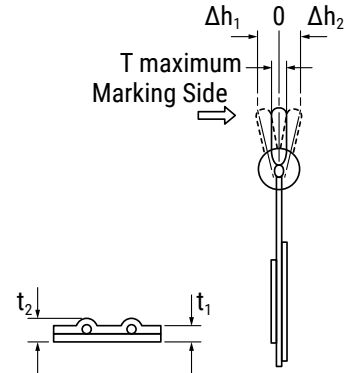

**Table 3 – Ammo/Reel Pack Taping Specifications**

Lead Spacing		5 mm				7.5 mm				10 mm		12.5 mm	
Lead Style		Straight		Preformed <sup>1</sup>		Straight		Preformed <sup>1</sup>		Straight	Preformed <sup>1</sup>	Straight	Preformed <sup>1</sup>
Item	Symbol	Dimensions (mm)											
Lead Spacing	F	5.0 ±1.0				7.5 ±1.0				10.0 ±1.0		12.5 ±1.0	
Component Pitch	P	12.7 ±1.0	25.4 ±2.0	12.7 ±1.0	25.4 ±2.0	12.7 ±1.0	25.4 ±2.0	12.7 ±1.0	25.4 ±2.0	25.4 ±2.0		25.4 ±2.0	
Sprocket Hole Pitch	P <sub>0</sub>	12.7 ±0.3				12.7 ±0.3				12.7 ±0.3		12.7 ±0.3	
Sprocket Hole Center to Component Center	P <sub>2</sub>	6.35 ±1.5	12.7 ±1.5	6.35 ±1.5	12.7 ±1.5	6.35 ±1.5	12.7 ±1.5	6.35 ±1.5	12.7 ±1.5	12.7 ±1.5		12.7 ±1.5	
Sprocket Hole Center to Lead Center	P <sub>1</sub>	3.85 ±0.7	10.2 ±1.5	3.85 ±0.7	10.2 ±1.5	2.6 ±0.7	8.95 ±1.5	2.6 ±0.7	8.95 ±1.5	7.7 ±1.5		6.45 ±1.5	
Body Diameter	D	See "Product Ordering Codes and Ratings" section of this document.											
Component Alignment (side/side)	ΔS	0 ±2.0											
Carrier Tape Width	W	18.0 +1.0/-0.5											
Sprocket Hole Position	W <sub>1</sub>	9.0 ±0.5											

<sup>1</sup> Preformed (crimped) lead configurations include vertical kink, outside kink, and inside kink. See "Lead Configurations" and "Ordering Information" sections of this document for further details.

<sup>2</sup> Also referred to as "lead length" in this document.

## Radial Leaded Ceramic Disc Capacitors

Safety Standard Recognized, C700, Encapsulated,  
KJY Type, X1 440/400 VAC/Y2 300/250 VAC (Industrial Grade)

**Table 3 – Ammo Pack Taping Specifications cont.**

Lead Spacing		5 mm		7.5 mm		10 mm		12.5 mm	
Lead Style		Straight	Preformed <sup>1</sup>	Straight	Preformed <sup>1</sup>	Straight	Preformed <sup>1</sup>	Straight	Preformed <sup>1</sup>
Item	Symbol	Dimensions (mm)							
Height to Seating Plane <sup>2</sup> (preformed leads <sup>1</sup> )	H <sub>0</sub>	N/A	16.0 +2.0/-0	N/A	16.0 +2.0/-0	N/A	16.0 +2.0/-0	N/A	16.0 +2.0/-0
Height to Seating Plane <sup>2</sup> (straight leads)	H	20.0 +1.5/-1.0	N/A	20.0 +1.5/-1.0	N/A	20.0 +1.5/-1.0	N/A	20.0 +1.5/-1.0	N/A
Lead Protrusion	ℓ	2.0 maximum							
Diameter of Sprocket Hole	D <sub>0</sub>	4.0 ±0.2							
Lead Diameter	φd	0.6 ±0.1							
Carrier Tape Thickness	t <sub>1</sub>	0.6 ±0.3							
Total Thickness (Carrier Tape, Hold-Down Tape and Lead)	t <sub>2</sub>	1.5 maximum							
Component Alignment (front/back)	Δh <sub>1</sub>	2.0 maximum							
	Δh <sub>2</sub>								
Cut Out Length	L	11.0 maximum							
Hold-Down Tape Width	W <sub>0</sub>	10.0 minimum							
Hold-Down Tape Position	W <sub>2</sub>	3.0 maximum							
Coating Extension on Leads (meniscus)	e	3.0 maximum for straight lead; not to exceed the bend for preformed <sup>1</sup> lead configurations.							
Body Thickness	T	8.0 maximum							

<sup>1</sup> Prefromed (crimped) lead configurations include vertical kink and outside kink. See "Lead Configurations" and "Ordering Information" sections of this document for further details.

<sup>2</sup> Also referred to as "lead length" in this document.

## Application Notes:

### Storage and Operating Conditions:

The Insulating coating of these devices does not form an air and moisture tight seal. Avoid exposure to moisture and do not use or store these devices in a corrosive atmosphere, especially where chloride gas, sulfide gas, acid, alkali, salt or the like are present. Before cleaning, bonding or molding these devices, it is important to verify that your process does not affect product quality and performance. KEMET recommends testing and evaluating the performance of a cleaned, bonded or molded product prior to implementing and/or qualifying any of these processes. Store the capacitors where the temperature and relative humidity do not exceed 40 degrees centigrade and 70% respectively. For optimum solderability, capacitor stock should be used promptly, preferably within 24 months of receipt.

### Working Voltage:

Application voltage (V<sub>p-p</sub> or V<sub>o-p</sub>) must not exceed the voltage rating of the capacitor. Irregular voltages can be generated for a transient period of time when voltage is initially applied and/or removed from a circuit. It is important to choose a capacitor with a voltage rating greater than or equal to these irregular voltages.

## Radial Leaded Ceramic Disc Capacitors

Safety Standard Recognized, C700, Encapsulated,  
KJY Type, X1 440/400 VAC/Y2 300/250 VAC (Industrial Grade)

### Application Notes (cont.):

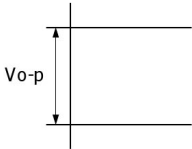
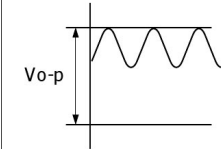
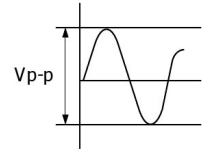
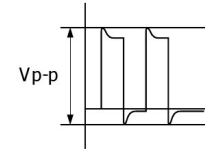
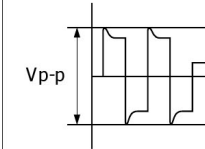
Voltage	DC Voltage	DC+AC Voltage	AC Voltage	Pulse Voltage (1)	Pulse Voltage (2)
Positional Measurement					

#### Operating Temperature and Self-Generating Heat:

The surface temperature of a capacitor should be kept below the upper limit of its rated operating temperature range. Be sure to take into account the heat generated by the capacitor itself. When the capacitor is used in a high-frequency current, pulse current or similar current, it may produce self-generated heat due to dielectric loss. Temperature rise due to self-generated heating should not exceed 20°C (while operated at an atmosphere temperature of 25°C).

#### Handling - Vibration and Impact:

Do not expose these devices or their leads to excessive shock or vibration during use.

**FAILURE TO FOLLOW THE ABOVE CAUTIONS MAY RESULT, WORST CASE, IN A SHORT CIRCUIT AND CAUSE FUMING OR PARTIAL DISPERSION WHEN THE PRODUCT IS USED.**

**Radial Leaded Ceramic Disc Capacitors**  
Safety Standard Recognized, C700, Encapsulated,  
KJY Type, X1 440/400 VAC/Y2 300/250 VAC (Industrial Grade)

## **KEMET Electronics Corporation Sales Offices**

For a complete list of our global sales offices, please visit <https://www.yageogroup.com/SalesResources/SalesOffices>

### **Disclaimer**

All product specifications, statements, information and data (collectively, the "Information") in this datasheet are subject to change. The customer is responsible for checking and verifying the extent to which the Information contained in this publication is applicable to an order at the time the order is placed. All Information given herein is believed to be accurate and reliable, but it is presented without guarantee, warranty, or responsibility of any kind, expressed or implied.

Statements of suitability for certain applications are based on KEMET Electronics Corporation's ("KEMET") knowledge of typical operating conditions for such applications, but are not intended to constitute – and KEMET specifically disclaims – any warranty concerning suitability for a specific customer application or use. The Information is intended for use only by customers who have the requisite experience and capability to determine the correct products for their application. Any technical advice inferred from this Information or otherwise provided by KEMET with reference to the use of KEMET's products is given gratis, and KEMET assumes no obligation or liability for the advice given or results obtained.

Although KEMET designs and manufactures its products to the most stringent quality and safety standards, given the current state of the art, isolated component failures may still occur. Accordingly, customer applications which require a high degree of reliability or safety should employ suitable designs or other safeguards (such as installation of protective circuitry or redundancies) in order to ensure that the failure of an electrical component does not result in a risk of personal injury or property damage.

Although all product-related warnings, cautions and notes must be observed, the customer should not assume that all safety measures are indicated or that other measures may not be required.

*KEMET is a registered trademark of KEMET Electronics Corporation.*