

Features

- Halogen Free. "Green" Device (Note 1)
- Low Voltage, Low Inductance
- High Current Rectifier Schottky Diode
- For Power Supply
- Epoxy Meets UL 94 V-0 Flammability Rating
- Moisture Sensitivity Level 1
- Lead Free Finish/RoHS Compliant ("P" Suffix Designates RoHS Compliant. See Ordering Information)
- AEC-Q101 Qualified

Maximum Ratings

- Operating Junction Temperature Range: -55°C to +150°C
- Storage Temperature Range: -55°C to +150°C
- Thermal Resistance(Note2): 625°C/W Junction to Ambient

MCC Part Number	Maximum Recurrent Peak Reverse Voltage	Maximum RMS Voltage	Maximum DC Blocking Voltage
RB751S-40HE3	40V	28V	40V

Electrical Characteristics @ 25°C Unless Otherwise Specified

Average forward current	$I_{F(AV)}$	30mA	
Peak Forward Surge Current	I_{FSM}	1A	$t_p < 8.3ms$
Power Dissipation	P_D	200mW	
Max Forward Voltage	V_F	0.37V	$I_F = 1mA$
Max Reverse Current	I_R	0.5µA	$V_R = 30V$
Min Reverse Breakdown Voltage	$V_{(BR)}$	40V	$I_R = 10uA$
Max Junction Capacitance	C_J	5pF	$V_R = 0V, f = 1MHz$
Max Reverse Recovery Time	t_{rr}	7ns	$I_F = I_R = 10mA, I_{rr} = 0.1 \times I_R, R_L = 100\Omega$

Note: 1. Halogen free "Green" products are defined as those which contain <900ppm bromine, <900ppm chlorine (<1500ppm total Br + Cl) and <1000ppm antimony compounds.

Note: 2. Part mounted on FR-4 board with recommended pad layout.

40 Volts Schottky Barrier Diode

SOD-523

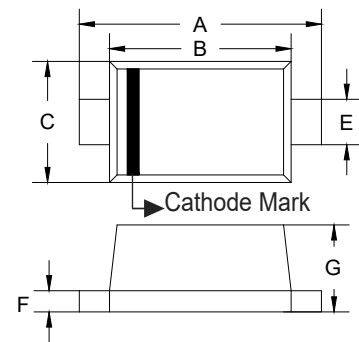

DIM	DIMENSIONS				NOTE
	INCHES		MM		
	MIN	MAX	MIN	MAX	
A	0.059	0.067	1.50	1.70	
B	0.043	0.051	1.10	1.30	
C	0.030	0.033	0.75	0.85	
E	0.010	0.014	0.25	0.35	
F	0.003	0.008	0.08	0.20	
G	0.020	0.026	0.50	0.65	

Suggested Solder Pad Layout

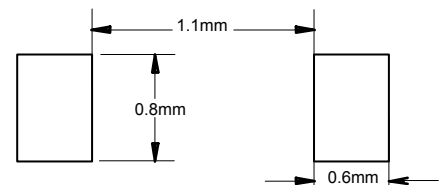

Internal Structure and Marking Code

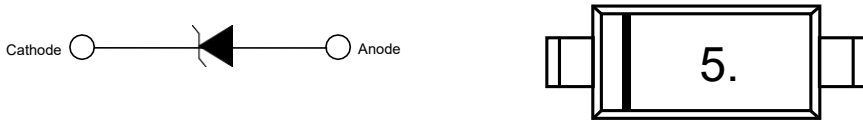

Curve Characteristics

Fig. 1 - Typical Instantaneous Forward Characteristics

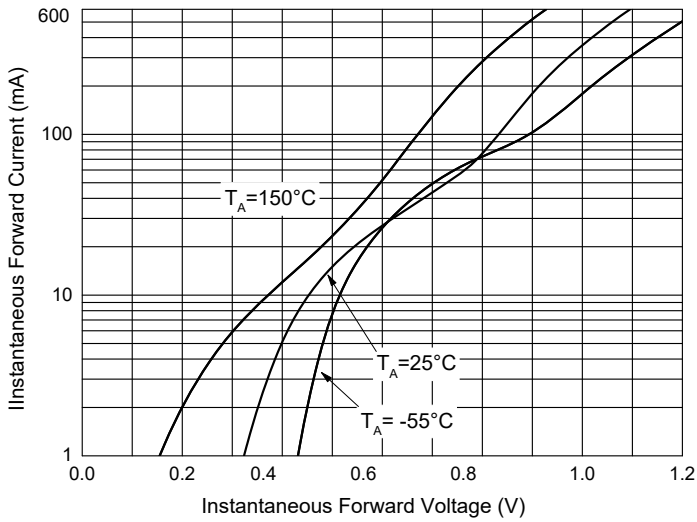

Fig. 2 - Typical Reverse Leakage Characteristics

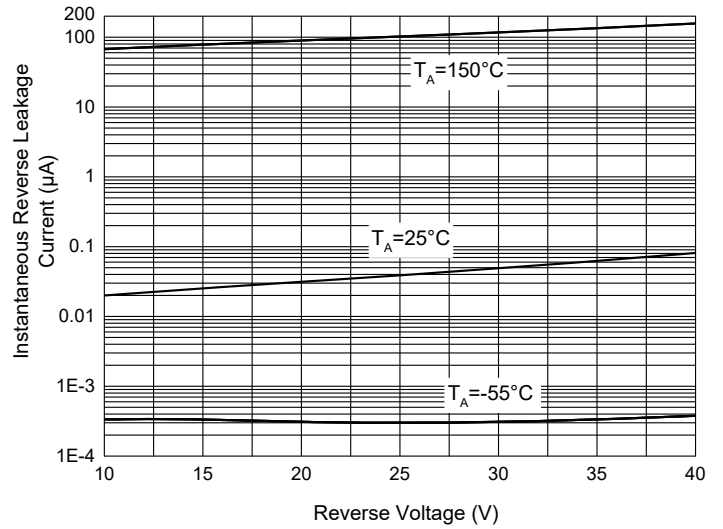

Fig. 3 - Capacitance Characteristics

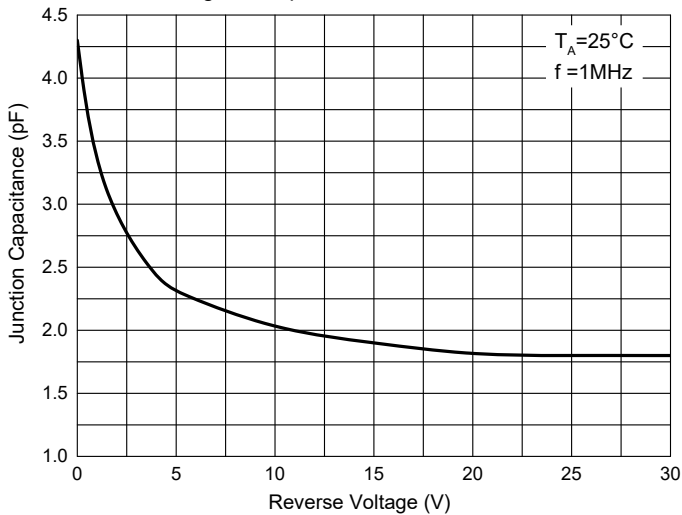
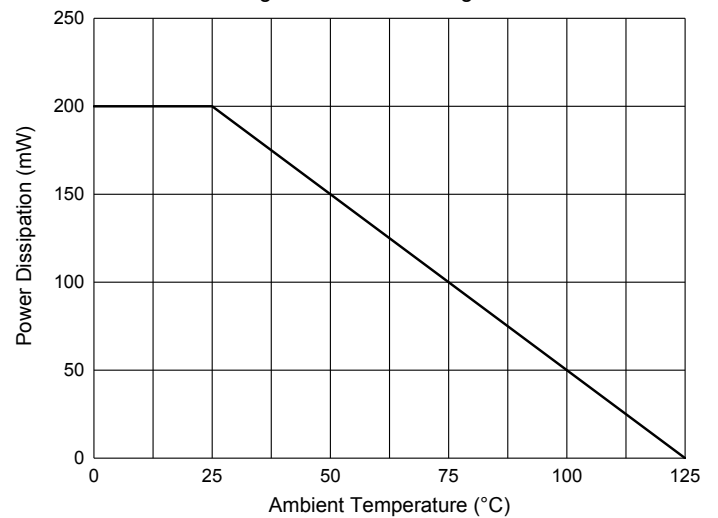

Fig. 4 - Power Derating Curve



Ordering Information

Device	Packing
Part Number-TP	Tape&Reel: 8Kpcs/Reel
Part Number-T3P	Tape&Reel: 3Kpcs/Reel

For packaging details, go to our website at <https://www.mccsemi.com/pdf/productpackaging/SOD-523%20Package.pdf>

IMPORTANT NOTICE

Micro Commercial Components Corp. reserves the right to make changes without further notice to any product herein to make corrections, modifications, enhancements, improvements, or other changes. **Micro Commercial Components Corp.** does not assume any liability arising out of the application or use of any product described herein; neither does it convey any license under its patent rights, nor the rights of others. The user of products in such applications shall assume all risks of such use and will agree to hold **Micro Commercial Components Corp.** and all the companies whose products are represented on our website, harmless against all damages. **Micro Commercial Components Corp.** products are sold subject to the general terms and conditions of commercial sale, as published at <https://www.mccsemi.com/Home/TermsAndConditions>.

LIFE SUPPORT

MCC's products are not authorized for use as critical components in life support devices or systems without the express written approval of Micro Commercial Components Corporation.

CUSTOMER AWARENESS

Counterfeiting of semiconductor parts is a growing problem in the industry. Micro Commercial Components (MCC) is taking strong measures to protect ourselves and our customers from the proliferation of counterfeit parts. MCC strongly encourages customers to purchase MCC parts either directly from MCC or from Authorized MCC Distributors who are listed by country on our web page cited below. Products customers buy either from MCC directly or from Authorized MCC Distributors are genuine parts, have full traceability, meet MCC's quality standards for handling and storage. **MCC will not provide any warranty coverage or other assistance for parts bought from Unauthorized Sources.** MCC is committed to combat this global problem and encourage our customers to do their part in stopping this practice by buying direct or from authorized distributors.