

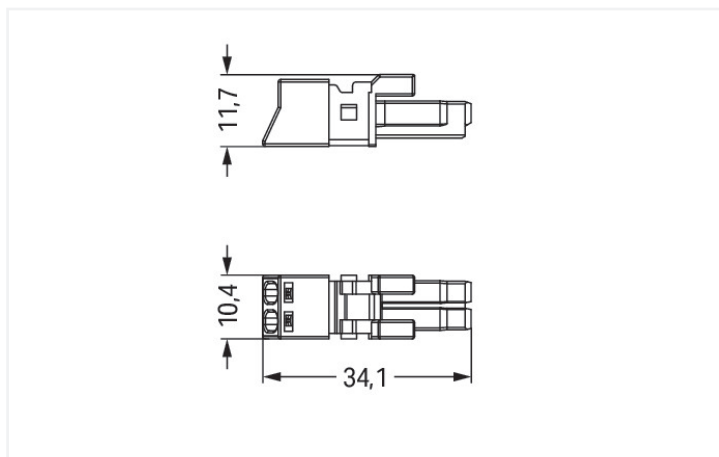

Color: ■ gray



Dimensions in mm

Female connector/socket WINSTA® MINI 2-pole

Use effective pluggable connections instead of laborious screw connections: With the WINSTA® MINI female connector/socket 2-pole. Our pluggable installation connectors with spring pressure connection technology work completely without screw connections. They allow flexible, error-free installation in numerous possible uses. For greater security in electrical installations, the pluggable installation connector is provided with mechanical protection against mismatching. B coding enables the WINSTA® MINI pluggable installation connectors to be used for application control in automation, mechanical engineering and robotics. If only limited space is available, our smallest pluggable connection system, WINSTA® MINI, consistently displays its strengths. It saves space, and, thanks to Push-in CAGE CLAMP® spring pressure connection technology, it additionally saves time, since the connection is low-maintenance and requires no screw connections.

Lower costs through fast commissioning and elimination of service expenses – solutions from WINSTA® MINI

WINSTA® is the pluggable connection system that is ideally tailored to the strict requirements of electrical installation. It allows error-free installation of cables and components, quickly and reliably. Now you can also cut installation expenses without compromising safety and quality: with protection against mismatching eliminates the need for servicing and prevents unnecessary downtime.

- protection against mismatching eliminates errors
- easy tool-free operation, a wide range of coding options
- with B coding for controllers such as lighting fixtures and sun blinds
- flexible installation to save space
- quick replacement of defective units during ongoing operation

Notes

General safety information

1. Nur von Elektrofachkraft oder einer für die Tätigkeit elektrisch unterwiesenen Person (EUP nach DIN VDE 0105-100) anzuwenden!
2. Nicht unter Spannung/Last installieren!
3. Nur für bestimmungsgemäßen Gebrauch einsetzen!
4. Nationale Vorschriften/Normen/Richtlinien beachten!
5. Technische Daten der Produkte beachten!
6. Auf die richtige Polbelegung achten!
7. Keine beschädigten/verschmutzten Komponenten verwenden!
8. Leiterarten, -querschnitte, Abisolierlängen und Leitungsdurchmesser beachten!
9. Leiter bis zum Anschlag einführen!
10. Nur mit Verriegelungsklinke und Zugentlastung verwenden!
11. Originalzubehör verwenden!

To be sold only with installation instructions!

Variants:

Other pole markings

Other versions (or variants) can be requested from WAGO Sales or configured at <https://configurator.wago.com/>.

Electrical data

Ratings per	IEC/EN 60664-1		
Overvoltage category	III	III	II
Pollution degree	3	2	2
Nominal voltage	250 V	-	-
Rated impulse withstand voltage	4 kV	-	-
Rated current	16 A	-	-

Approvals per	UL 1977
Rated voltage	600 V
Rated current	14 A

General information

Note on contact resistance	approx. 1 mΩ of contact resistance approx. 0.25 mΩ contact transition plug/ socket
----------------------------	------------------------------------------------------------------------------------------

Connection Data

Clamping units	2
Total number of potentials	2

Connection 1

Connection technology	Push-in CAGE CLAMP®
Actuation type	Operating tool Push-in
Nominal cross-section	1.5 mm ² / 16 AWG
Solid conductor	0.25 ... 1.5 mm ² / 22 ... 16 AWG
Solid conductor; push-in termination	0.75 ... 1.5 mm ² / 20 ... 16 AWG
Stranded conductor	0.25 ... 1 mm ² / 22 ... 18 AWG
Fine-stranded conductor	0.25 ... 1.5 mm ² / 22 ... 16 AWG
Fine-stranded conductor; with insulated ferrule	0.25 ... 0.75 mm ² / 22 ... 20 AWG
Fine-stranded conductor; with uninsulated ferrule	0.25 ... 0.75 mm ² / 22 ... 20 AWG
Fine-stranded conductor; with ferrule; push-in termination	0.75 mm ² / 20 AWG
Strip length	9 mm / 0.35 inches
Pole number	2
Conductor entry direction to mating direction	0°

Physical data

Pin spacing	4.4 mm / 0.173 inches
Width	10.4 mm / 0.409 inches
Height	11.7 mm / 0.461 inches
Depth	34.1 mm / 1.343 inches

Mechanical data

Use	Control technology
Coding	B
Variable coding	No
Marking	1 2
Potential marking	1 2
Mating force of a plug-in connection	approx. 20 ... 70 N (depending on pole number)
Retention force of a plug-in connection	Locked: > 80 N
Unmating force of a plug-in connection	Unlocked: approx. 20 ... 70 N (depending on pole number)
Number of mating cycles	200, without resistive load
Protection type	IP20; IP40 with strain relief housing

Plug-in connection

Contact type (pluggable connector)	Female connector/socket
Connector (connection type)	for conductor
Mismating protection	Yes
Note on mismating protection	All WINSTA® components are 100% protected against mismating when: a.) plugging different numbers of poles b.) plugging while rotated 180 c.) plugging while laterally staggered d.) plugging one pole
Locking lever	Can be retrofitted
Locking of plug-in connection	Locking lever
Note on locking system	All connectors for mounted installations (snap-in versions for lighting fixtures or devices, all types of PCB and distribution connectors) are factory-equipped with locking levers to ensure plugs and sockets are securely locked. Additional locking levers are only required for flying leads (plug/socket).

Material data

Note (material data)	Information on material specifications can be found here
Color	gray
Cover color	gray
Material group	I
Insulation material (main housing)	Polyamide (PA66)
Flammability class per UL94	V0
Clamping spring material	Chrome-nickel spring steel (CrNi)
Contact material	Copper or copper alloy; surface-treated
Contact Plating	Tin
Fire load	0.046 MJ
Weight	2.6 g

Environmental requirements

Processing temperature	-5 ... +40 °C
Continuous operating temperature	-35 ... +85 °C
Note on continuous operating temperature	Insulating parts for temperatures ≤ 105 °C

Commercial data

Product Group	20 (Winsta)
PU (SPU)	50 pcs
Packaging type	Box
Country of origin	PL
GTIN	4055143499583
Customs tariff number	85366990990

Product Classification

UNSPSC	39121402
eCl@ss 10.0	27-44-06-05
eCl@ss 9.0	27-44-06-05
ETIM 9.0	EC002560
ETIM 10.0	EC002560
ECCN	NO US CLASSIFICATION

Environmental Product Compliance

RoHS Compliance Status	Compliant, No Exemption
------------------------	-------------------------

Approvals / Certificates

General approvals



Approval	Standard	Certificate Name
CB DEKRA Certification B.V.	IEC 61984	NL-64351
CB DEKRA Certification B.V.	EN 61984	71-112993
cURus Underwriters Laboratories Inc.	UL 1977	E45171
KEMA/KEUR DEKRA Certification B.V.	EN 60320	2148952.04

Declarations of conformity and manufacturer's declarations

Approval	Standard	Certificate Name
EU-Declaration of Confor- mity WAGO GmbH & Co. KG	-	-
UK-Declaration of Confor- mity WAGO GmbH & Co. KG	-	-

Approvals for marine applications



Approval	Standard	Certificate Name
DNV GL Det Norske Veritas, Ger- manischer Lloyd	-	TAE00001Z6
LR Lloyds Register	EN 61535	LR23317167TA
PRS Polski Rejestr Statków	-	TE/1096/880590/23

Downloads

Environmental Product Compliance

Compliance Search			
Environmental Product Compliance 890-242			↓

Documentation

Bid Text			
890-242	19.02.2019	xml 2.97 KB	↓
890-242	08.06.2015	doc 23.00 KB	↓

CAD/CAE-Data

CAD data	
2D/3D Models 890-242	↓

CAE data	
EPLAN Data Portal 890-242	↓
WSCAD Universe 890-242	↓
ZUKEN Portal 890-242	↓

1 Compatible Products

1.1 System counterpart

1.1.1 Cable assembly



Item No.: 891-8992/205-103
pre-assembled connecting cable; Eca; Plug/open-ended; 2-pole; Cod. B; Control cable 2 x 1.0 mm²; 1 m; 1,00 mm²; gray

Item No.: 891-8992/005-103
pre-assembled interconnecting cable; Eca; Socket/plug; 2-pole; Cod. B; Control cable 2 x 1.0 mm²; 1 m; 1,00 mm²; gray

1.1.2 Distribution box



Item No.: 899-632/102-000
Distribution box; Relay switching; 2 inputs; 1 output; Cod. A, B; MINI, MIDI; black

1.1.3 Distribution connector



Item No.: 890-1601

T-distribution connector; 2-pole; Cod. B; 1 input; 2 outputs; 2 locking levers; gray

Item No.: 890-1701

T-distribution connector; 2-pole; Cod. B; 1 input; 2 outputs; 3 locking levers; for flying leads; gray

1.1.4 Male connector/plug



Item No.: 890-852/011-000

Plug for PCBs; angled; 2-pole; Cod. B; gray

Item No.: 890-852

Plug for PCBs; straight; 2-pole; Cod. B; gray

Item No.: 890-252

Plug; 2-pole; 1,50 mm²; gray

Item No.: 890-752

Snap-in plug; 2-pole; Cod. B; 1,50 mm²; gray

1.2 Required Accessories

1.2.1 Locking system

1.2.1.1 Locking system



Item No.: 890-111

Locking lever; for flying leads; for tool operation; black

Item No.: 890-131

Locking lever; for flying leads; for tool operation; white

Item No.: 890-101

Locking lever; for manual operation; black

Item No.: 890-121

Locking lever; for manual operation; white

1.2.2 Strain relief

1.2.2.1 Strain relief housing



Item No.: 890-502/342-000

Strain relief housing; 2-pole; with locking clip; for 1 cable; 3.8 ... 8.2 mm; 17.5 mm; black

Item No.: 890-512/342-000

Strain relief housing; 2-pole; with locking clip; for 1 cable; 3.8 ... 8.2 mm; 17.5 mm; white

Item No.: 890-502

Strain relief housing; 2-pole; with locking clip; for 1 cable; 3.8 ... 8.2 mm; 30 mm; black

Item No.: 890-512

Strain relief housing; 2-pole; with locking clip; for 1 cable; 3.8 ... 8.2 mm; 30 mm; white

1.3 Optional Accessories

1.3.1 Cover

1.3.1.1 Cover



Item No.: 897-2001

Protective cap; Type 1; for sockets and plugs; PVC; red

1.3.2 Installation

1.3.2.1 Mounting accessories



Item No.: 890-310

Mounting carrier; 2- to 5-pole; for flying leads; black



Item No.: 890-311

Mounting carrier; 2- to 5-pole; for flying leads; white

1.3.3 Tool

1.3.3.1 Operating tool



Item No.: 890-382

Operating tool; 2-way; green



Item No.: 210-719

Operating tool; Blade: 2.5 x 0.4 mm; with a partially insulated shaft

Installation Notes

Conductor termination

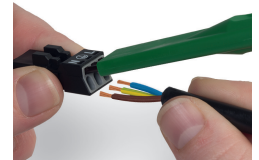
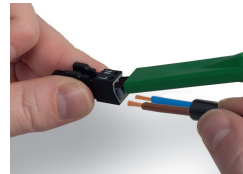
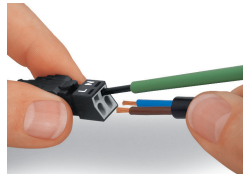

1. Strip length, outer insulation = 30 mm (2-pole), 37 mm (3-pole), 45 mm (4- and 5-pole)
2. Strip length = 9 mm
3. Extended ground conductor = 8 mm

To terminate fine-stranded conductors, open the clamping unit via screwdriver – 2.5 mm blade width – and insert a stripped conductor until it hits the backstop. Terminate solid conductors by simply pushing them in.

To terminate fine-stranded conductors, open clamping units via operating tool (890-382) and insert stripped conductors until they hit backstop. Terminate solid conductors by simply pushing them in.

To terminate fine-stranded conductors, open clamping units via operating tool (890-383) and insert stripped conductors until they hit backstop. Terminate solid conductors by simply pushing them in.

Installation

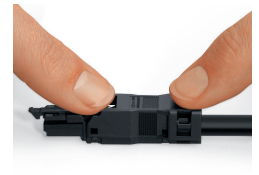
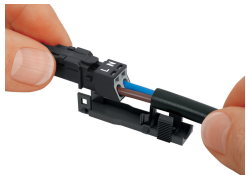

Latch the wired connector into the base of the strain relief housing.

Push down strain relief clamp by hand.

Push down strain relief clamp with 2.5 mm screwdriver alternately on both sides.

Latch the top of the strain relief housing.



The printed marking of the connector is clearly visible in the openings of the strain relief housing.

Mismatching protection

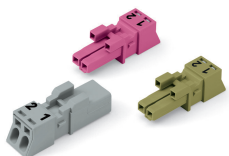

B-coded connectors with different colors can be plugged together.

Important note:

Different colors and/or pole markings are used for circuit identification.

Only connectors of the same color and same pole marking must be plugged together.

B-coded connectors (shown in gray) not only differ in color, but also in their design, making them incompatible with other coded connectors.