

FH34 Series

0.5mm Pitch, 1.0mm Height, Top and Bottom Contact Back Flip FPC/FFC Connector



TM Flip-Lock Pioneer Hirose



P= 0.5mm



Back Flip



Top/Bottom Contact



Apr. 1. 2026 Copyright 2026 HIROSE ELECTRIC CO., LTD. All Rights Reserved.



Product Page
<https://www.hirose.com/en/product/series/FH34SRJ>

Mar. 2025

Features

1. Low-profile 0.5mm Pitch, Both Upper and Lower Contacts Connector

Since it can be used in both top contact and bottom contact, freedom of Item design is improved.

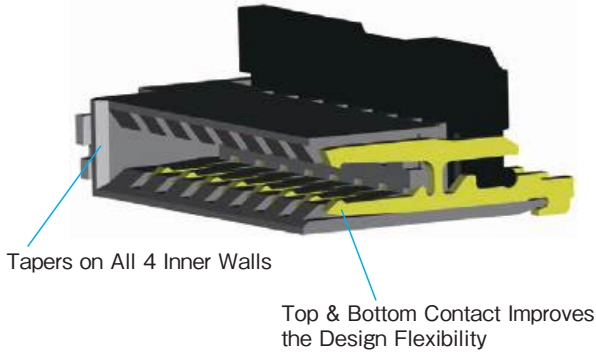

Top and Bottom Contact Design
Smooth FPC Insertion

2. FH34SRJ: Back Flip & Unique Contact Design Greatly Improves FPC Retention Force

In Horizontal Direction: Approx. 2.6 times Higher (Comparison Against Conventional Type)
In Vertical Direction: Approx. 2 times Higher (Comparison Against Conventional Type)

3. FH34D: FPC/FFC with Tabs and Improved FPC Retention Force

In Horizontal Direction: FH34SRJ + Approx. 2.5N (10pos.)

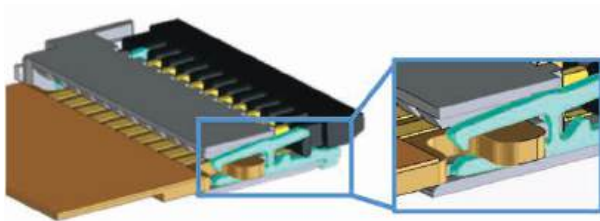

4. High Speed Transmission

Excellent impedance characteristics and high speed transmission. Supports eDP (ver 1.3) and MIPI (D-PHY) standards.

FH34SRJ/FH34D Differential Impedance
130ps rise time (20-80%)

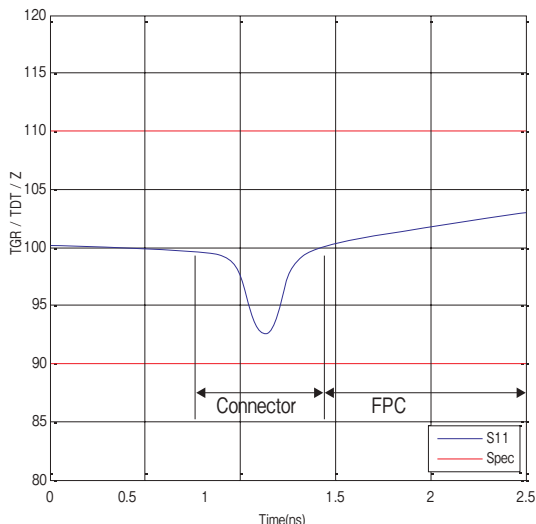

5. Delivery with Lock Open

No need to open actuator before working because delivery with the lock open.

6. Easy FPC/FFC Insertion

The taper guide at the housing opening allows easy FPC/FFC insertion.

7. Compatible with 0.3mm thick FPC/FFC

Supports 0.3mm thick FPC/FFC which is the standard thickness of 0.5mm pitch connector. (The moderate rigidity of the reinforcing plate prevents deformation of the FPC and prevents troubles during insertion and mating.)

8. No pattern prohibited area is required on the lower surface of the connector. (Overmolding Design)

The lower surface of the connector is covered with plastic to eliminate the exposure of contact, so there is no restriction on the circuit board pattern. Increased flexibility in board design.

9. Halogen-free

Connector does not use chlorine or bromine above the standard value.

*AS defined by IEC 61249-2-21.
 Br: 900ppm Max., Cl: 900ppm Max.,
 Br+Cl: 1,500ppm Max.

10. Automatic Mounting

Pick & place mounting is possible with boss packaging. (5,000pcs for reel)
 Also, the normal product is 5,000pcs for reel, but we also have 500pcs for reel as trial use. (The outer shape of the embossed reel is ϕ 180mm.)

Product Specifications

Rated Current (Note 1)	0.5A	Operating Temperature (Note 2)	-55 to +105°C
Rated Voltage	50Vms AC/DC	Storage Temperature (Note 3)	-10 to +50°C
		Operating Humidity Range	RH 90% Max. (No Condensation)
		Storage Humidity Range (Note 3)	RH 90% Max. (No Condensation)

Recommended FPC/FFC Specifications	t=0.3 ± 0.03 Gold Plated
------------------------------------	--------------------------

Item	Specifications	Conditions
Insulation Resistance	500M Ω Min.	Measured at 100V DC
Withstanding Voltage	No flashover or insulation breakdown	250V AC for 1 min.
Contact Resistance	100m Ω Max. Includes FPC/FFC conductor resistance.	Measured at 1mA
Mating Durability	Contact Resistance: 100m Ω Max. No damage, cracks or part dislocation.	20 times
Vibration Resistance	No electrical discontinuity of 1 μ s Min. Contact Resistance: 100m Ω Max. No damage, cracks or part dislocation.	Frequency: 10 to 55Hz, single amplitude of 0.75mm, 10 cycles in each of the 3 axis
Shock Resistance	No electrical discontinuity of 1 μ s Min. Contact Resistance: 100m Ω Max. No damage, cracks or part dislocation.	Acceleration of 981m/s ² , 6ms duration, sine halfwave, 3 cycles in each of the 3 axis
Steady-state Moisture Resistance	Contact Resistance: 100m Ω Max. Insulation Resistance: 50M Ω Min. No damage, cracks or part dislocation.	96 hours at temperature of 40°C and humidity of 90 to 95%
Temperature Cycle	Contact Resistance: 100m Ω Max. Insulation Resistance: 50M Ω Min. No damage, cracks or part dislocation.	Temperature: -55°C → +15 to +35 → +105°C → +15 to +35°C Time: 30 → 2 to 3 → 30 → 2 to 3 minutes Above conditions repeated for 5 cycles
Solder Heat Resistance	No deformation in appearance or significant damage to contacts.	Reflow: At recommended temperature profile Hand Solder: Solder iron temperature of 350 ± 10°C for 5 ± 1 seconds Max.

Note 1: When passing the current through all of the contacts, use 70% of the current rating.

Note 2: Includes the temperature rise due to current flow.

Note 3: Storage refers to long-term storage of products before board mounting. The operating temperature and humidity apply to the non-energized state after mounting.

Materials / Finish

Part	Materials	Color / Finish	Remarks
Insulator	LCP	Gray	UL94V-0
	Polyamide Resin	Black	
Contact	Copper Alloy	Nickel Barrier Gold Plated	-
Retention Tab	Copper Alloy	Pure Tin Reflow Plated	-

Product Number Structure

Refer to the chart below when determining the product specifications from the product number.

Please select from the product numbers listed in this catalog when placing orders.

FH 34 SRJ - 30S - 0.5 SH (50)

① ② ③ ④ ⑤ ⑥ ⑦

① Series Name	FH	⑤ Contact Pitch	0.5mm
② Series No.	34	⑥ Termination Type	SH: SMT Horizontal Mounting Type
③ Tab	SRJ: Incompatible with FPC/FFC Tabs D: Compatible with FPC/FFC Tabs	⑦ Specification	(50): Standard (5,000pcs) (99): For Trial only (500pcs)
④ No. of Pos.	4 to 50		

FH34SRJ Connector Dimensions

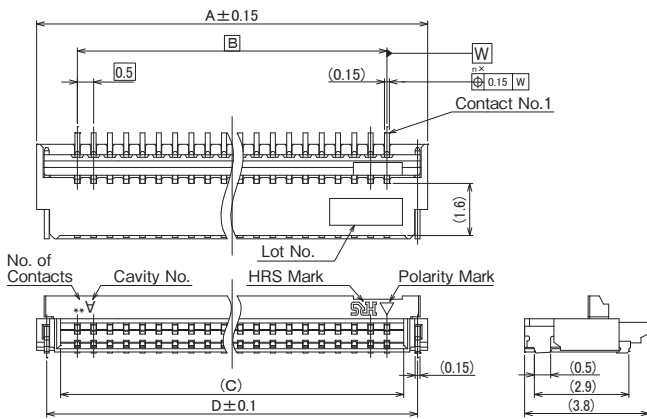

- *'n' indicates the number of positions.
- Note 1 : The coplanarity of the contact and solder tab lead is 0.1mm Max.
- Note 2 : Packaged in tape and reel only. Check the "Packaging Specification" for details
- Note 3 : Sink mark reliefs may be added due to improvements.
Black spots may appear on the mold resin but this does not affect the product quality.
- Note 4 : After reflow, the contact plating may change color, however this does not represent a quality issue.

Unit : mm

Part No.	HRS No.	No. of Pos.	A	B	C	D	Purchase Unit	
							(##) : (50)	(##) : (99)
FH34SRJ-4S-0.5SH(##)	CL0580-1238-7-##	4	4.0	1.5	2.53	3.38	5,000pcs per reel	500pcs per reel
FH34SRJ-5S-0.5SH(##)	CL0580-1264-7-##	5	4.5	2.0	3.03	3.88		
FH34SRJ-6S-0.5SH(##)	CL0580-1236-1-##	6	5.0	2.5	3.53	4.38		
FH34SRJ-7S-0.5SH(##)	CL0580-1200-0-##	7	5.5	3.0	4.03	4.88		
FH34SRJ-8S-0.5SH(##)	CL0580-1231-8-##	8	6.0	3.5	4.53	5.38		
FH34SRJ-9S-0.5SH(##)	CL0580-1262-1-##	9	6.5	4.0	5.03	5.88		
FH34SRJ-10S-0.5SH(##)	CL0580-1251-5-##	10	7.0	4.5	5.53	6.38		
FH34SRJ-11S-0.5SH(##)	CL0580-1258-4-##	11	7.5	5.0	6.03	6.88		
FH34SRJ-12S-0.5SH(##)	CL0580-1253-0-##	12	8.0	5.5	6.53	7.38		
FH34SRJ-14S-0.5SH(##)	CL0580-1252-8-##	14	9.0	6.5	7.53	8.38		
FH34SRJ-16S-0.5SH(##)	CL0580-1259-7-##	16	10.0	7.5	8.57	9.38		
FH34SRJ-18S-0.5SH(##)	CL0580-1248-0-##	18	11.0	8.5	9.57	10.38		
FH34SRJ-20S-0.5SH(##)	CL0580-1256-9-##	20	12.0	9.5	10.57	11.38		
FH34SRJ-22S-0.5SH(##)	CL0580-1254-3-##	22	13.0	10.5	11.57	12.38		
FH34SRJ-24S-0.5SH(##)	CL0580-1255-6-##	24	14.0	11.5	12.57	13.38		
FH34SRJ-26S-0.5SH(##)	CL0580-1247-8-##	26	15.0	12.5	13.57	14.38		
FH34SRJ-30S-0.5SH(##)	CL0580-1232-0-##	30	17.0	14.5	15.57	16.38		
FH34SRJ-32S-0.5SH(##)	CL0580-1257-1-##	32	18.0	15.5	16.53	17.38		
FH34SRJ-34S-0.5SH(##)	CL0580-1261-9-##	34	19.0	16.5	17.53	18.38		
FH34SRJ-40S-0.5SH(##)	CL0580-1260-6-##	40	22.0	19.5	20.53	21.38		
FH34SRJ-45S-0.5SH(##)	CL0580-1265-0-##	45	24.5	22.0	23.03	23.88		
FH34SRJ-50S-0.5SH(##)	CL0580-1266-2-##	50	27.0	24.5	25.53	26.38		

Apr. 1. 2026 Copyright 2026 HIROSE ELECTRIC CO., LTD. All Rights Reserved.

FH34D Connector Dimensions

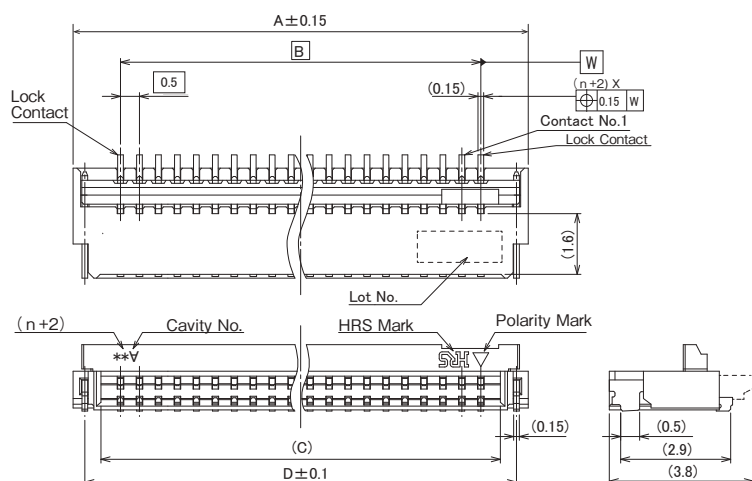

*'n' indicates the number of positions.

Note 1 : The coplanarity of the contact and solder tab lead is 0.1mm Max.

Note 2 : Packaged in tape and reel only. Check the "Packaging Specification" for details

Note 3 : Sink mark reliefs may be added due to improvements.

Black spots may appear on the mold resin but this does not affect the product quality.

Note 4 : After reflow, the contact plating may change color, however this does not represent a quality issue.

Unit : mm

Part No.	HRS No.	No. of Pos.	A	B	C	D	Purchase Unit	
							(##) : (50)	(##) : (99)
FH34D-4S-0.5SH(##)	CL0580-1274-0-##	4	5.0	2.5	3.53	4.38	5,000pcs per reel	500pcs per reel
FH34D-6S-0.5SH(##)	CL0580-1275-0-##	6	6.0	3.5	4.53	5.38		
FH34D-8S-0.5SH(##)	CL0580-1271-0-##	8	7.0	4.5	5.53	6.38		
FH34D-10S-0.5SH(##)	CL0580-1270-0-##	10	8.0	5.5	6.53	7.38		
FH34D-12S-0.5SH(##)	CL0580-1272-0-##	12	9.0	6.5	7.53	8.38		
FH34D-14S-0.5SH(##)	CL0580-1276-0-##	14	10.0	7.5	8.57	9.38		
FH34D-16S-0.5SH(##)	CL0580-1277-0-##	16	11.0	8.5	9.57	10.38		
FH34D-20S-0.5SH(##)	CL0580-1273-0-##	20	13.0	10.5	11.57	12.38		
FH34D-24S-0.5SH(##)	CL0580-1278-0-##	24	15.0	12.5	13.57	14.38		
FH34D-30S-0.5SH(##)	CL0580-1279-0-##	30	18.0	15.5	16.53	17.38		

Note1 : Products without HRS No. are currently being planned for development. Please contact a Hirose representative regarding questions on pin count variation development.

Unit : mm

Part No.	HRS No.	No. of Pos.	B	E	F	G
FH34SRJ-4S-0.5SH(##)	CL0580-1238-7-##	4	1.5	3.1	3.9	2.5
FH34SRJ-5S-0.5SH(##)	CL0580-1264-7-##	5	2.0	3.6	4.4	3.0
FH34SRJ-6S-0.5SH(##)	CL0580-1236-1-##	6	2.5	4.1	4.9	3.5
FH34SRJ-7S-0.5SH(##)	CL0580-1200-0-##	7	3.0	4.6	5.4	4.0
FH34SRJ-8S-0.5SH(##)	CL0580-1231-8-##	8	3.5	5.1	5.9	4.5
FH34SRJ-9S-0.5SH(##)	CL0580-1262-1-##	9	4.0	5.6	6.4	5.0
FH34SRJ-10S-0.5SH(##)	CL0580-1251-5-##	10	4.5	6.1	6.9	5.5
FH34SRJ-11S-0.5SH(##)	CL0580-1258-4-##	11	5.0	6.6	7.4	6.0
FH34SRJ-12S-0.5SH(##)	CL0580-1253-0-##	12	5.5	7.1	7.9	6.5
FH34SRJ-14S-0.5SH(##)	CL0580-1252-8-##	14	6.5	8.1	8.9	7.5
FH34SRJ-16S-0.5SH(##)	CL0580-1259-7-##	16	7.5	9.1	9.9	8.5
FH34SRJ-18S-0.5SH(##)	CL0580-1248-0-##	18	8.5	10.1	10.9	9.5
FH34SRJ-20S-0.5SH(##)	CL0580-1256-9-##	20	9.5	11.1	11.9	10.5
FH34SRJ-22S-0.5SH(##)	CL0580-1254-3-##	22	10.5	12.1	12.9	11.5
FH34SRJ-24S-0.5SH(##)	CL0580-1255-6-##	24	11.5	13.1	13.9	12.5
FH34SRJ-26S-0.5SH(##)	CL0580-1247-8-##	26	12.5	14.1	14.9	13.5
FH34SRJ-30S-0.5SH(##)	CL0580-1232-0-##	30	14.5	16.1	16.9	15.5
FH34SRJ-32S-0.5SH(##)	CL0580-1257-1-##	32	15.5	17.1	17.9	16.5
FH34SRJ-34S-0.5SH(##)	CL0580-1261-9-##	34	16.5	18.1	18.9	17.5
FH34SRJ-40S-0.5SH(##)	CL0580-1260-6-##	40	19.5	21.1	21.9	20.5
FH34SRJ-45S-0.5SH(##)	CL0580-1265-0-##	45	22.0	23.6	24.4	23.0
FH34SRJ-50S-0.5SH(##)	CL0580-1266-2-##	50	24.5	26.1	26.9	25.5

FH34D

Recommended PCB Mounting Pattern and Metal Mask Dimensions

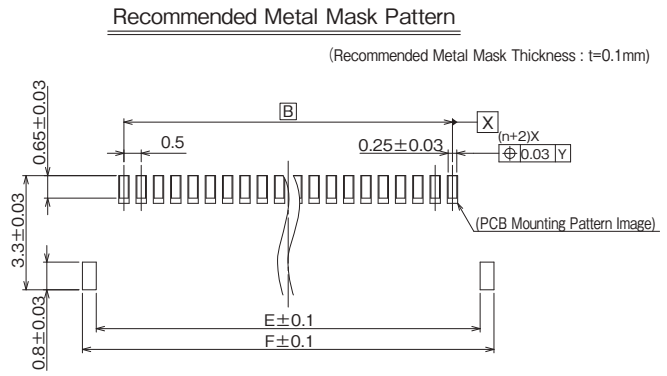
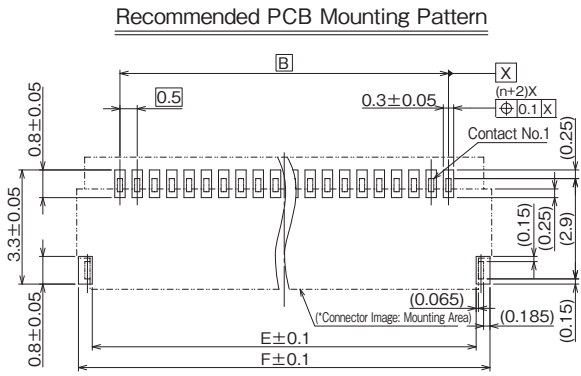

Recommended FPC/FFC Dimensions

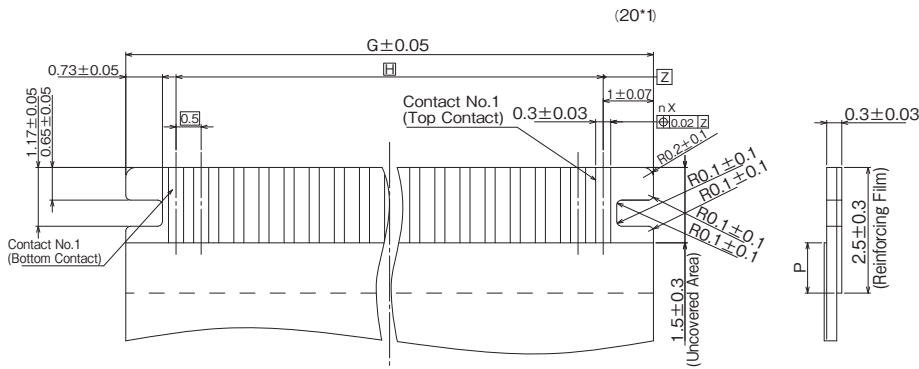

*n' indicates the number of positions.
 *P dimension must be at least 0.5mm.
 *The FPC recommended above is for FH34D series only.

Unit : mm

Part No.	HRS No.	No. of Pos.	B	E	F	G	H
FH34D-4S-0.5SH(##)	CL0580-1274-0-##	4	2.5	4.1	4.9	3.5	1.5
FH34D-6S-0.5SH(##)	CL0580-1275-0-##	6	3.5	5.1	5.9	4.5	2.5
FH34D-8S-0.5SH(##)	CL0580-1271-0-##	8	4.5	6.1	6.9	5.5	3.5
FH34D-10S-0.5SH(##)	CL0580-1270-0-##	10	5.5	7.1	7.9	6.5	4.5
FH34D-12S-0.5SH(##)	CL0580-1272-0-##	12	6.5	8.1	8.9	7.5	5.5
FH34D-14S-0.5SH(##)	CL0580-1276-0-##	14	7.5	9.1	9.9	8.5	6.5
FH34D-16S-0.5SH(##)	CL0580-1277-0-##	16	8.5	10.1	10.9	9.5	7.5
FH34D-20S-0.5SH(##)	CL0580-1273-0-##	20	10.5	12.1	12.9	11.5	9.5
FH34D-24S-0.5SH(##)	CL0580-1278-0-##	24	12.5	14.1	14.9	13.5	11.5
FH34D-30S-0.5SH(##)	CL0580-1279-0-##	30	15.5	17.1	17.9	16.5	14.5

Note1 : Products without HRS No. are currently being planned for development. Please contact a Hirose representative regarding questions on pin count variation development.

Apr. 1. 2026 Copyright 2026 HIROSE ELECTRIC CO., LTD. All Rights Reserved.

Packaging Specifications

FH34SRJ

Embossed Carrier Tape Dimensions

Tape Width : 24mm Max.

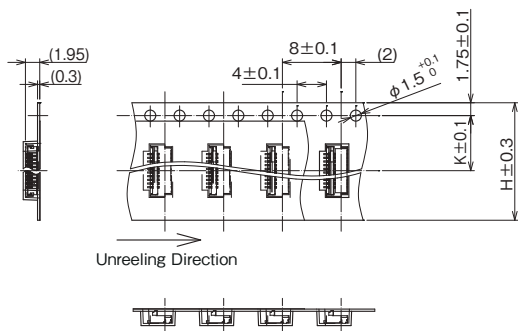

Tape Width : 32mm Min.

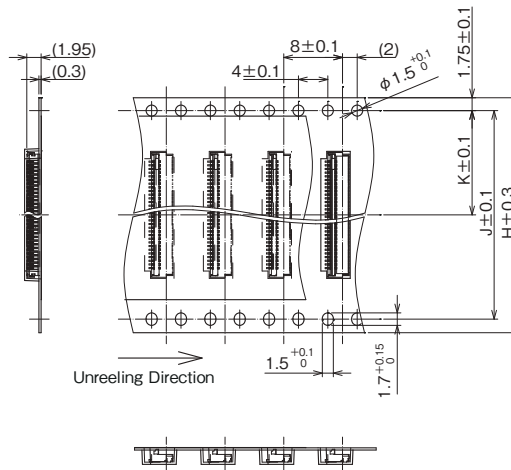

Reel Dimensions

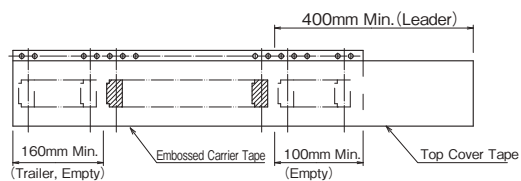
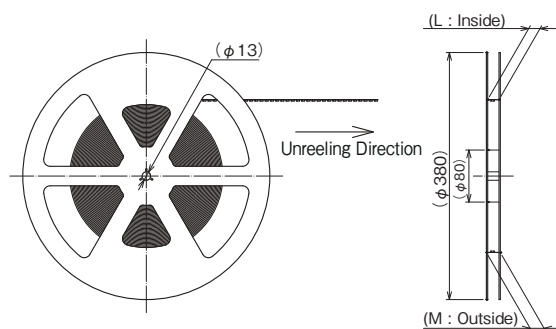

Unit : mm

Part No.	HRS No.	No. of Pos.	H	J	K	L	M
FH34SRJ-4S-0.5SH(##)	CL0580-1238-7-##	4	16	-	7.5	17.4	21.4
FH34SRJ-5S-0.5SH(##)	CL0580-1264-7-##	5		-			
FH34SRJ-6S-0.5SH(##)	CL0580-1236-1-##	6		-			
FH34SRJ-7S-0.5SH(##)	CL0580-1200-0-##	7		-			
FH34SRJ-8S-0.5SH(##)	CL0580-1231-8-##	8		-			
FH34SRJ-9S-0.5SH(##)	CL0580-1262-1-##	9		-			
FH34SRJ-10S-0.5SH(##)	CL0580-1251-5-##	10		-			
FH34SRJ-11S-0.5SH(##)	CL0580-1258-4-##	11		-			
FH34SRJ-12S-0.5SH(##)	CL0580-1253-0-##	12	24	-	11.5	25.4	29.4
FH34SRJ-14S-0.5SH(##)	CL0580-1252-8-##	14		-			
FH34SRJ-16S-0.5SH(##)	CL0580-1259-7-##	16		-			
FH34SRJ-18S-0.5SH(##)	CL0580-1248-0-##	18		-			
FH34SRJ-20S-0.5SH(##)	CL0580-1256-9-##	20		-			
FH34SRJ-22S-0.5SH(##)	CL0580-1254-3-##	22		-			
FH34SRJ-24S-0.5SH(##)	CL0580-1255-6-##	24		-			
FH34SRJ-26S-0.5SH(##)	CL0580-1247-8-##	26		-			
FH34SRJ-30S-0.5SH(##)	CL0580-1232-0-##	30	32	28.4	14.2	33.4	37.4
FH34SRJ-32S-0.5SH(##)	CL0580-1257-1-##	32					
FH34SRJ-34S-0.5SH(##)	CL0580-1261-9-##	34					
FH34SRJ-40S-0.5SH(##)	CL0580-1260-6-##	40	44	40.4	20.2	45.4	49.4
FH34SRJ-45S-0.5SH(##)	CL0580-1265-0-##	45					
FH34SRJ-50S-0.5SH(##)	CL0580-1266-2-##	50					

Apr. 1. 2026 Copyright 2026 HIROSE ELECTRIC CO., LTD. All Rights Reserved.

FH34D

Embossed Carrier Tape Dimensions

Tape Width : 24mm Max.

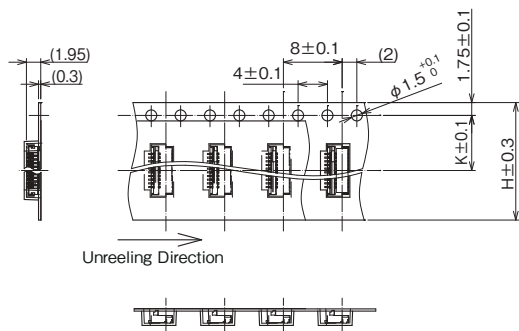

Tape Width : 32mm Min.

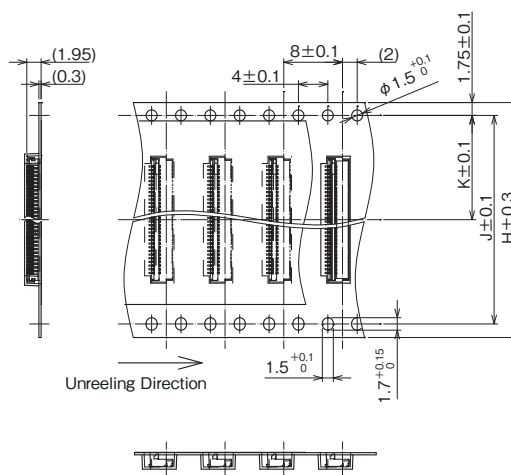

Reel Dimensions

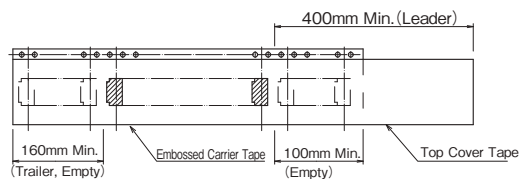
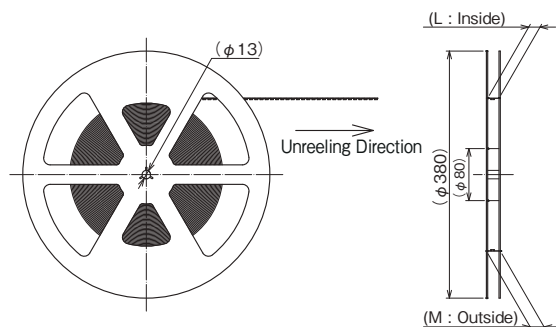

Unit : mm

Part No.	HRS No.	No. of Pos.	H	J	K	L	M
FH34D-4S-0.5SH(##)	CL0580-1274-0-##	4	16.0	-	7.5	17.4	21.4
FH34D-6S-0.5SH(##)	CL0580-1275-0-##	6		-			
FH34D-8S-0.5SH(##)	CL0580-1271-0-##	8		-			
FH34D-10S-0.5SH(##)	CL0580-1270-0-##	10	24.0	-	11.5	25.4	29.4
FH34D-12S-0.5SH(##)	CL0580-1272-0-##	12		-			
FH34D-14S-0.5SH(##)	CL0580-1276-0-##	14		-			
FH34D-16S-0.5SH(##)	CL0580-1277-0-##	16		-			
FH34D-20S-0.5SH(##)	CL0580-1273-0-##	20		-			
FH34D-24S-0.5SH(##)	CL0580-1278-0-##	24		-			
FH34D-30S-0.5SH(##)	CL0580-1279-0-##	30	32.0	28.4	14.2	33.4	37.4

Note1 : Products without HRS No. are currently being planned for development. Please contact a Hirose representative regarding questions on pin count variation development.

FH34SRJ/FH34D Series Recommended FPC/FFC Construction

1. Single-sided FPC

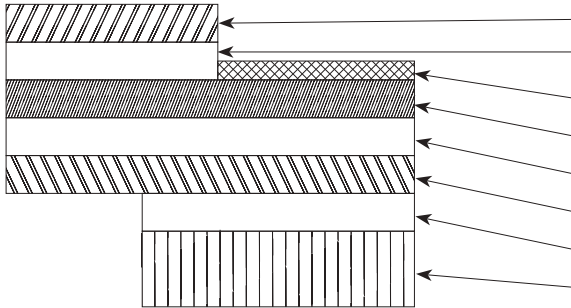

FPC : Flexible Printed Circuit

Material Name	Material	Thickness (μm)
Cover Lay Film	Polymide 1mil	(25)
Cover Adhesive		(25)
Surface Treatment	0.2μm Thick Gold Plated over 1 to 5μm Thick Nickel Underplating	3
Copper Foil	Cu 1oz	35
Base Adhesive	Thermosetting Adhesive	25
Base Film	Polymide 1mil	25
Reinforcement Adhesive	Thermosetting Adhesive	35
Reinforcement Film	Polymide 7mil	175
Total		298

2. Double-sided FPC

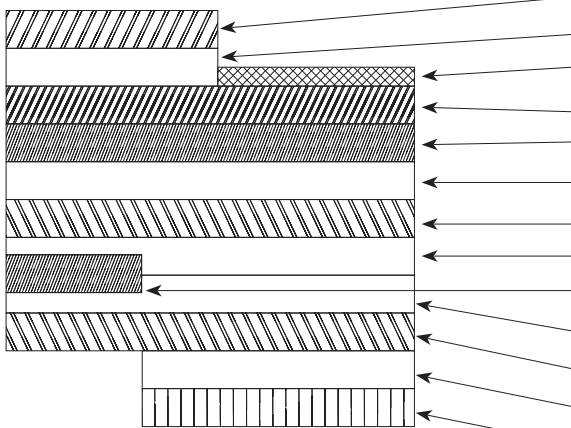

FPC : Flexible Printed Circuit

Material Name	Material	Thickness (μm)
Cover Lay Film	Polymide 1mil	(25)
Cover Adhesive		(25)
Surface Treatment	0.2μm Thick Gold Plated over 1 to 5μm Thick Nickel Underplating	3
Through-hole Copper	Cu	15
Copper Foil	Cu 1/2oz	18
Base Adhesive	Thermosetting Adhesive	18
Base Film	Polymide 1mil	25
Base Adhesive		18
Copper Foil	Cu 1/2oz	(18)
Cover Adhesive	Thermosetting Adhesive	25
Cover Lay Film	Polymide 1mil	25
Reinforcement Adhesive	Thermosetting Adhesive	50
Reinforcing Film	Polymide 4mil	100
Total		297

3. FFC

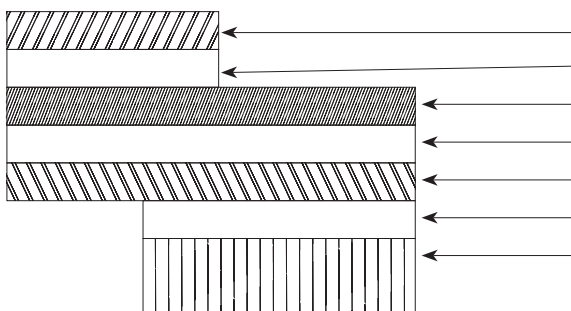

FFC : Flexible Flat Cable

Material Name	Material	Thickness (μm)
Polyester Film		(12)
Adhesive	Thermoplastic Polyester	(30)
Gold Plated Annealed Copper Foil		35
Adhesive	Polyester	30
Polyester		12
Adhesive	Polyester	30
Reinforcing Film	Polyester	188
Total		295

*The thickness tolerance is approximately $\pm 20 \mu m$.

1. This specifications is a recommended material configuration for FH34SRJ/FH34D series FPC (t=0.3 ± 0.03).
 2. Contact an FPC/FFC/Shielded FFC maker for details on component construction.

Temperature Profile

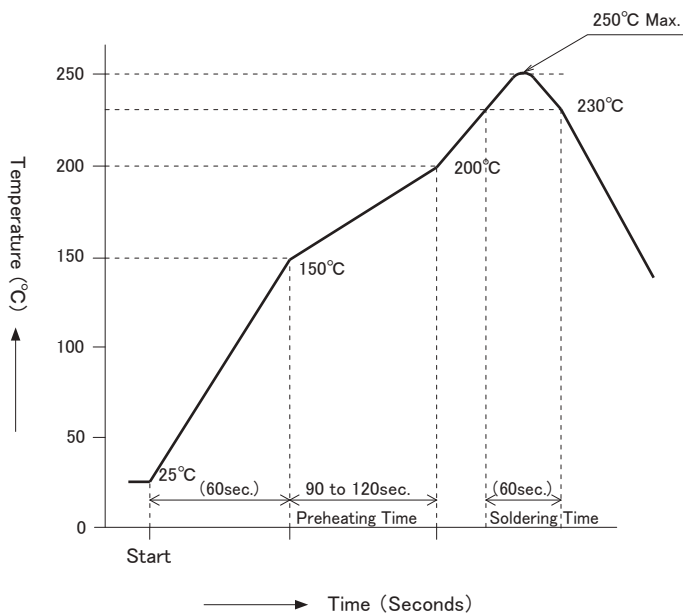

Applicable Conditions

Reflow Method : IR/Hot Air

Reflow Environment : Room Air

Solder : Paste Type Sn/3.0Ag/0.5Cu
(M705-GRN360-K2-V made by Senju Metal Industry Co.)

Test PCB : PCB Material and Size
Glass Epoxy 18.3 × 32.85 × 0.8mm
Land Size 0.3 × 0.8mm

Metal Mask : Thickness 0.1mm
Opening Size 0.25 × 0.65mm

This temperature profile is based on the above conditions.
It may vastly depending on solder paste type,
manufacturer, PCB size and mounting materials.
Please use only after checking the mounting conditions.

Operation and Precautions

This connector is a compact, thin item with a back flip structure, and care must be taken when handling it. Please check the following before using.

1. Initial Mounting State (Before FPC Insertion)

Since the product is delivered in an actuator open state, there is no need to operate the lock before inserting the FPC.

⚠ Caution

- Do not close actuator with the FPC not inserted.
- If you close actuator without inserting the FPC, the contact gap will narrow and the insertion force may increase.

The actuator packaged in the open condition.



2. FPC Insertion Method

Be sure to insert the FPC into the board so that it is horizontal to the board.

⚠ Caution

- Insert the FPC with actuator open.
- Inserting the FPC by rubbing it vertically, horizontally or diagonally may cause deformation of contact or poor contact.

Two Step Operation

Step 1

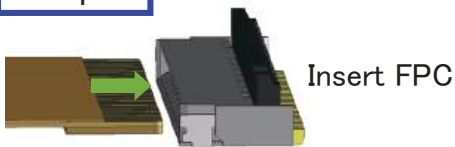

Step 2

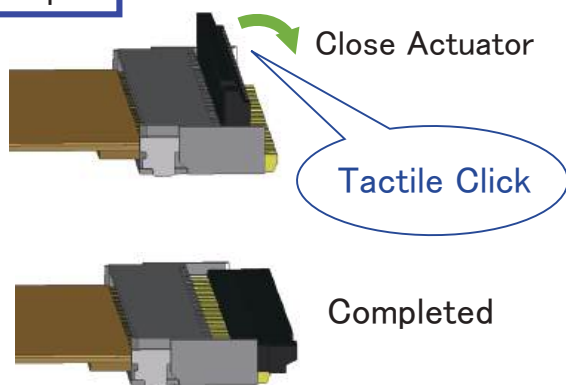

3. FPC Insertion Confirmation (When Used in Top Contact)

By visually comparing the end line of the housing opening with the boundary line of the FPC pattern, it is possible to prevent the erroneous insertion state of oblique insertion and shallow insertion.

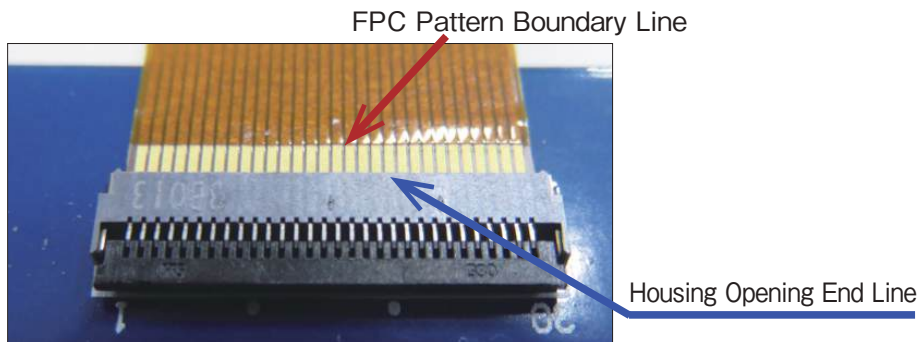

OK Correct FPC Position



✗ Skewed FPC Insertion



✗ Shallow FPC Insertion

4. Locking

Rotate and press down on actuator.

At that time, rotate the middle part or the whole of actuator with the belly of your finger and completely knock it down. (Do not push down on only one side of actuator. Actuator may twist, causing damage.)

*Be careful not to apply excessive force to the housing during work.

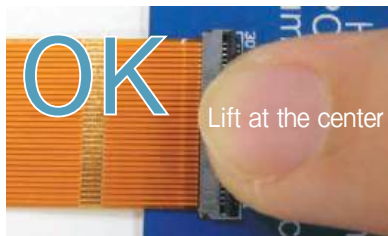
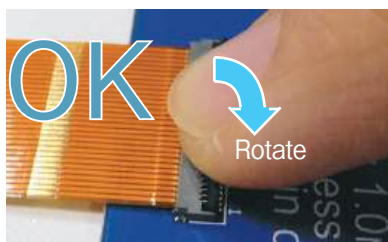

5. FPC/FFC Removal (Lock Release)

- (1) Slowly push up actuator with a springy motion, then pull out the FPC after unlocking.
 - (2) Operate the center of actuator to unlock it.
(Please do not push up only one side of actuator. Actuator may twist, causing damage.)
- *Actuator only opens to 90°. Do not attempt to open actuator at any further angle or apply more force than necessary.

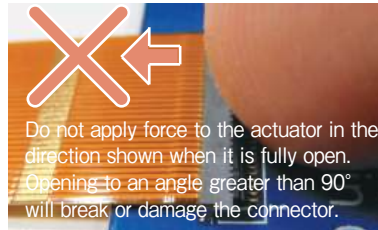
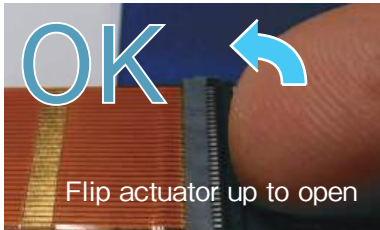

*This connector uses a back flip type structure, and the FPC insertion direction and actuator are in different directions. Do not open from the FPC insertion side.

6. FPC Routing

FPC should be routed in a manner that no strain or load is exerted onto the FPC. Placing any strain on the FPC may result in unintentional disconnect or damage to the FPC, which can lead to issues such as contact failure.

⚠ Caution

- Do not allow the FPC or reinforcing film to touch the casings, housings or any other items.
- When routing the FPC, make sure that no strain or load is applied to the connector in a pulling, pushing or side-to-side motion. Additionally, make sure that no excessive upward or downward force is applied to the connector.
- When routing the FPC, make sure that there is a stress free path for the FPC and the reinforcing film is parallel to the PCB. Observe correct bend radiuses.
- Do not place or mount any parts that will interfere with the FPC routing.

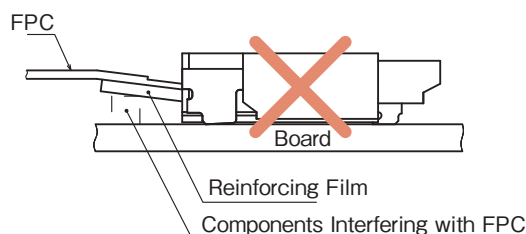
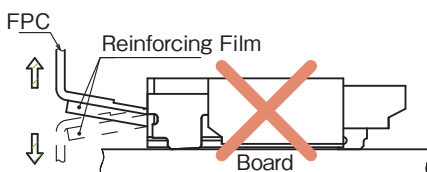
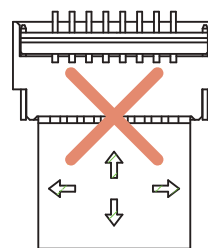
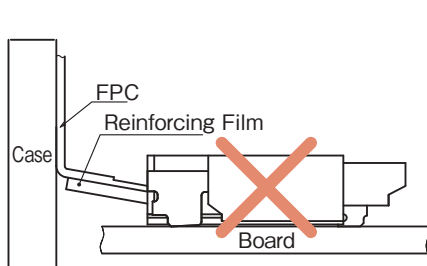

Precautions when Mounting Connectors on the PCB

About the Warpage Amount of the Board

Try to minimize the warpage of the board.

The flatness of this connector is 0.1mm Max. However, if the amount of warpage is large, soldering failure may occur.

About Mounting to FPC

When mounting the FPC, design a reinforcing plate for easy handling.

We recommend that the reinforcing plate be made of glass epoxy material and be 0.3mm Min.

About Loads on Connectors

Do not apply an external force greater than 0.5N to the connector before mounting it, as this can damage the connector.

Do not insert the FPC in front of mounting or operate the connector.

Load on Board

- Break a large number of the board
- Screw on the board

Be careful not to apply a load to the board during the assembly process as described above.

The connector may be damaged.

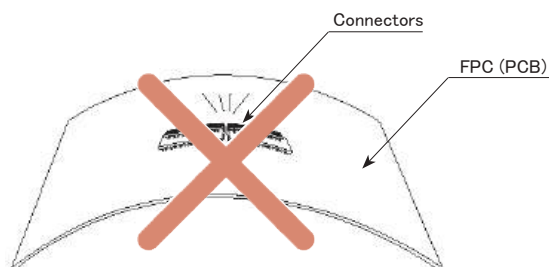

Precautions for Hand Soldering

When performing hand soldering such as repair, please pay attention to the following.

- (1) Do not reflow or hand-solder with FPC inserted into the connector.
- (2) Do not apply excessive heat or allow the solder iron to touch anything other than the lead of the connector.
Doing so may cause the connector to deform or melt.
- (3) Do not use excessive solder (or flux).

If too much solder (flux) is supplied to contact, the solder and flux will adhere to the contacts and the rotating parts of actuator, causing poor contact and actuator rotation. Also, if solder is supplied excessively to retention pad, it will interfere with the rotation of Actuator, causing damage to the connector.

While Taking into Consideration

Specifications mentioned in this catalog are reference values.

When considering to order or use this product, please review the Drawing and Product Specifications sheets.

Use an appropriate cable when using the connector in combination with cables.

If considering usage of a non-specified cable, please contact your sales representative.

If assembly process is done by jigs & tools which are not identified by Hirose, the warranty of the product may be affected.

If considering usage for below mentioned applications, please contact your sales representative.

In cases where the application will demand a high level of reliability, such as automotive, medical instruments, public infrastructure, aerospace/defense etc. Hirose must review before assurance of reliability can be given.