

Automotive-grade trench gate field-stop 600 V, 60 A very high speed V series IGBT featuring freewheeling SiC diode

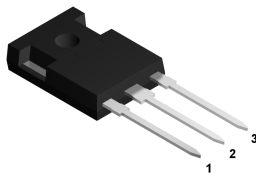

TO-247 long leads

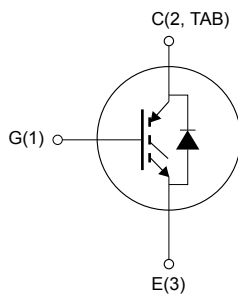

NG1E3C2T



Product status link

[STGWA60V60DWFAG](#)

Product summary

Order code	STGWA60V60DWFAG
Marking	G60V60DWFAG
Package	TO-247 long leads
Packing	Tube

Features

- AEC-Q101 qualified 
- Maximum junction temperature: $T_J = 175\text{ }^\circ\text{C}$
- $V_{CE(sat)} = 1.85\text{ V (typ.) @ } I_C = 60\text{ A}$
- Tail-less switching current
- Tight parameter distribution
- Low thermal resistance
- Positive $V_{CE(sat)}$ temperature coefficient
- Silicon carbide diode with no-reverse recovery charge is co-packaged in freewheeling configuration

Applications

- Automotive converters
- Totem-pole power factor correction

Description

This device is an IGBT developed using an advanced proprietary trench gate field-stop structure. The device is part of the V series IGBTs, which represent an optimum compromise between conduction and switching losses to maximize the efficiency of very high frequency converters. Furthermore, the positive $V_{CE(sat)}$ temperature coefficient and very tight parameter distribution result in safer paralleling operation.

Co-packed with the IGBT a silicon carbide diode has been adopted: no recovery is shown at turn-off of the SiC diode and the already minimal capacitive turn-off behavior is independent of temperature. Its high forward surge capability ensures good robustness during transient phases.

1 Electrical ratings

Table 1. Absolute maximum ratings

Symbol	Parameter	Value	Unit
V_{CES}	Collector-emitter voltage ($V_{GE} = 0\text{ V}$)	600	V
I_C	Continuous collector current at $T_C = 25\text{ °C}$	80 ⁽¹⁾	A
	Continuous collector current at $T_C = 100\text{ °C}$	60	
I_{CP} ⁽¹⁾	Pulsed collector current ($t_p \leq 1\text{ }\mu\text{s}$, $T_J < 175\text{ °C}$)	240	
V_{GE}	Gate-emitter voltage	± 20	V
I_F	Continuous forward current at $T_C = 100\text{ °C}$	30	A
I_{FRM} ⁽¹⁾	Repetitive peak forward current ($T_C = 100\text{ °C}$, $T_J = 175\text{ °C}$, $\delta = 0.1$)	125	
P_{TOT}	Total power dissipation at $T_C = 25\text{ °C}$	375	W
T_{STG}	Storage temperature range	-55 to 150	°C
T_J	Operating junction temperature range	-55 to 175	°C

1. Limited by bonding wires.

Table 2. Thermal data

Symbol	Parameter	Value	Unit
R_{thJC}	Thermal resistance junction-case IGBT	0.4	°C/W
	Thermal resistance junction-case diode	0.9	
R_{thJA}	Thermal resistance junction-ambient	50	

2 Electrical characteristics

$T_C = 25\text{ °C}$ unless otherwise specified

Table 3. Static characteristics

Symbol	Parameter	Test conditions	Min.	Typ.	Max.	Unit
$V_{(BR)CES}$	Collector-emitter breakdown voltage	$V_{GE} = 0\text{ V}, I_C = 2\text{ mA}$	600			
$V_{CE(sat)}$	Collector-emitter saturation voltage	$V_{GE} = 15\text{ V}, I_C = 60\text{ A}$		1.85	2.3	V
		$V_{GE} = 15\text{ V}, I_C = 60\text{ A}, T_J = 125\text{ °C}$		2.15		
		$V_{GE} = 15\text{ V}, I_C = 60\text{ A}, T_J = 175\text{ °C}$		2.35		
$V_{GE(th)}$	Gate threshold voltage	$V_{CE} = V_{GE}, I_C = 1\text{ mA}$	5	6	7	
V_F	Forward on-voltage	$I_F = 30\text{ A}$		1.45	1.88	
		$I_F = 30\text{ A}, T_J = 125\text{ °C}$		1.7		
		$I_F = 30\text{ A}, T_J = 175\text{ °C}$		1.85		
I_{CES}	Collector cut-off current	$V_{GE} = 0\text{ V}, V_{CE} = 600\text{ V}$			250	μA
I_{GES}	Gate-emitter leakage current	$V_{CE} = 0\text{ V}, V_{GE} = \pm 20\text{ V}$			± 250	nA

Table 4. Dynamic characteristics

Symbol	Parameter	Test conditions	Min.	Typ.	Max.	Unit
C_{ies}	Input capacitance	$V_{CE} = 25\text{ V}, f = 1\text{ MHz},$ $V_{GE} = 0\text{ V}$	-	8000	-	pF
C_{oes}	Output capacitance		-	280	-	
C_{res}	Reverse transfer capacitance		-	170	-	
Q_g	Total gate charge	$V_{CC} = 480\text{ V}, I_C = 60\text{ A},$ $V_{GE} = 0\text{ to }15\text{ V}$ (see Figure 28. Gate charge test circuit)	-	314	-	nC
Q_{ge}	Gate-emitter charge		-	48	-	
Q_{gc}	Gate-collector charge		-	142	-	

Table 5. Switching characteristics (inductive load)

Symbol	Parameter	Test conditions	Min.	Typ.	Max.	Unit
$t_{d(on)}$	Turn-on delay time	$V_{CE} = 400\text{ V}, I_C = 60\text{ A},$ $V_{GE} = 15\text{ V}, R_G = 4.7\text{ }\Omega$ (see Figure 27. Test circuit for inductive load switching)		35	-	ns
t_r	Current rise time			20	-	ns
$(di/dt)_{on}$	Turn-on current slope			2834	-	A/ μs
$t_{d(off)}$	Turn-off delay time			190	-	ns
t_f	Current fall time			22	-	ns
$E_{on}^{(1)}$	Turn-on switching energy			1.02	-	mJ
$E_{off}^{(2)}$	Turn-off switching energy			0.37	-	mJ
E_{ts}	Total switching energy			1.39	-	mJ

Symbol	Parameter	Test conditions	Min.	Typ.	Max.	Unit
$t_{d(on)}$	Turn-on delay time	$V_{CE} = 400\text{ V}$, $I_C = 60\text{ A}$, $V_{GE} = 15\text{ V}$, $R_G = 4.7\ \Omega$, $T_J = 175\text{ }^\circ\text{C}$ (see Figure 27. Test circuit for inductive load switching)		31	-	ns
t_r	Current rise time			24	-	ns
$(di/dt)_{on}$	Turn-on current slope			2263	-	A/ μs
$t_{d(off)}$	Turn-off delay time			228	-	ns
t_f	Current fall time			52	-	ns
$E_{on}^{(1)}$	Turn-on switching energy			0.99	-	mJ
$E_{off}^{(2)}$	Turn-off switching energy			0.78	-	mJ
E_{ts}	Total switching energy			1.77	-	mJ

1. Including the reverse recovery of the SiC diode.
2. Including the tail of the collector current.

Table 6. SiC diode switching characteristics (inductive load)

Symbol	Parameter	Test conditions	Min.	Typ.	Max.	Unit	
t_{rr}	Reverse recovery time	$I_F = 60\text{ A}$, $V_R = 400\text{ V}$, $V_{GE} = 15\text{ V}$, $dI_F/dt = 2570\text{ A}/\mu\text{s}$ (see Figure 27. Test circuit for inductive load switching)	-	200	-	ns	
Q_{rr}	Reverse recovery charge			-	282	-	nC
I_{rrm}	Reverse recovery current			-	8.5	-	A
dI_{rr}/dt	Peak rate of fall of reverse recovery current during t_b			-	30	-	A/ μs
E_{rr}	Reverse recovery energy			-	87	-	μJ
t_{rr}	Reverse recovery time	$I_F = 60\text{ A}$, $V_R = 400\text{ V}$, $V_{GE} = 15\text{ V}$, $dI_F/dt = 2570\text{ A}/\mu\text{s}$, $T_J = 175\text{ }^\circ\text{C}$ (see Figure 27. Test circuit for inductive load switching)	-	400	-	ns	
Q_{rr}	Reverse recovery charge			-	700	-	nC
I_{rrm}	Reverse recovery current			-	11	-	A
dI_{rr}/dt	Peak rate of fall of reverse recovery current during t_b			-	19	-	A/ μs
E_{rr}	Reverse recovery energy			-	225	-	μJ

2.1 Electrical characteristics (curves)

Figure 1. Power dissipation vs case temperature

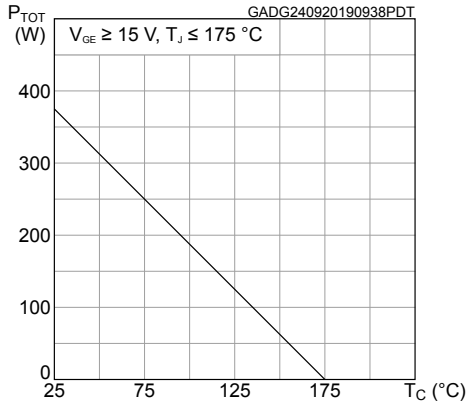

Figure 2. Collector current vs case temperature

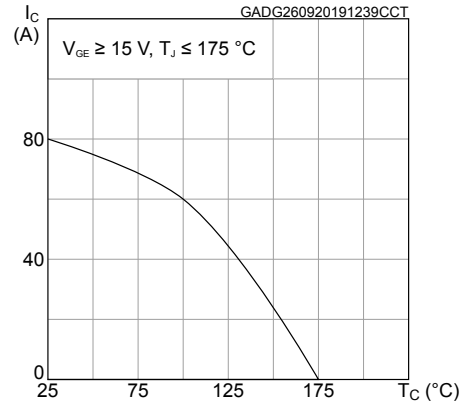

Figure 3. Output characteristics ($T_J = 25 \text{ }^\circ\text{C}$)

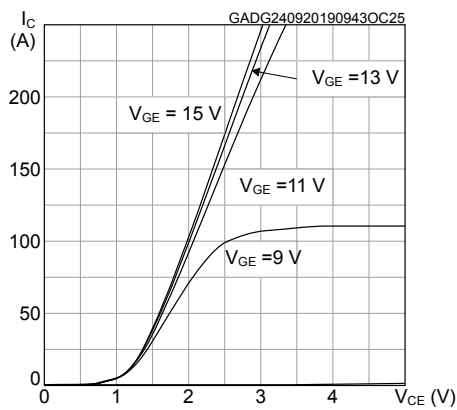

Figure 4. Output characteristics ($T_J = 175 \text{ }^\circ\text{C}$)

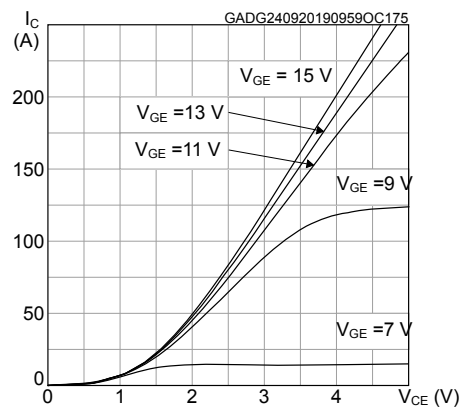

Figure 5. $V_{CE(sat)}$ vs junction temperature

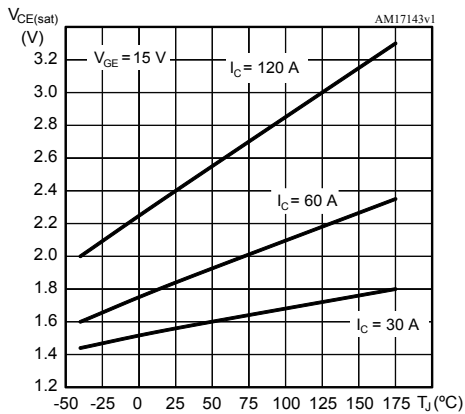

Figure 6. $V_{CE(sat)}$ vs collector current

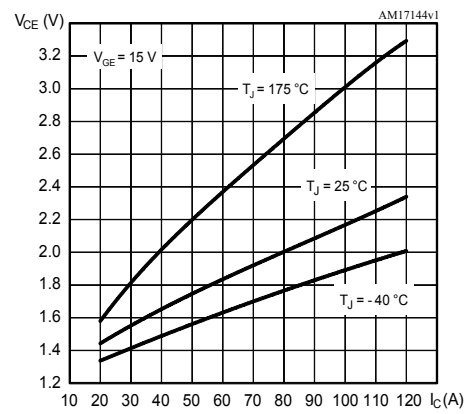

Figure 7. Collector current vs. switching frequency

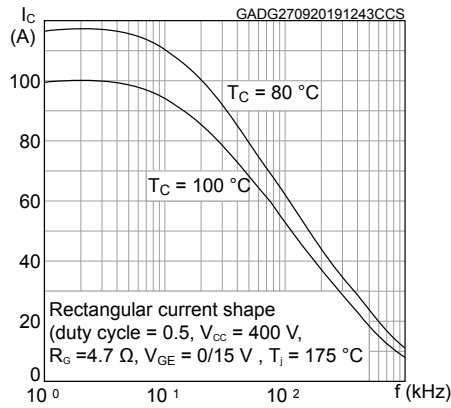

Figure 8. Forward bias safe operating area

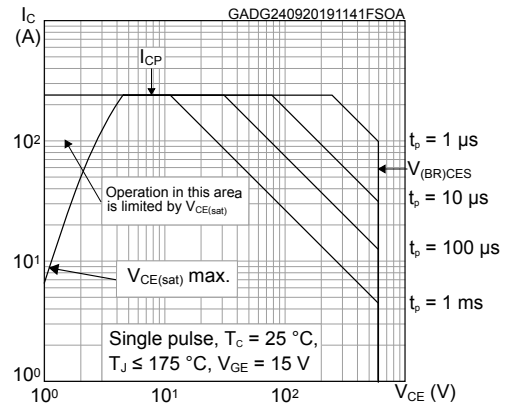

Figure 9. Transfer characteristics

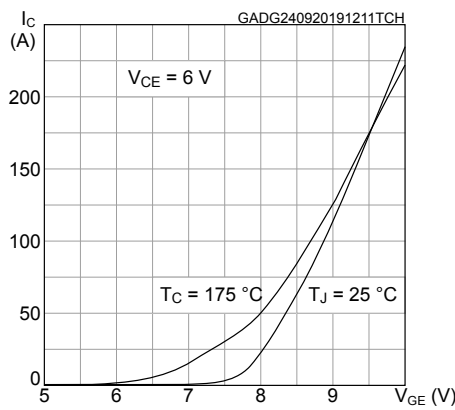

Figure 10. Diode Vf vs forward current

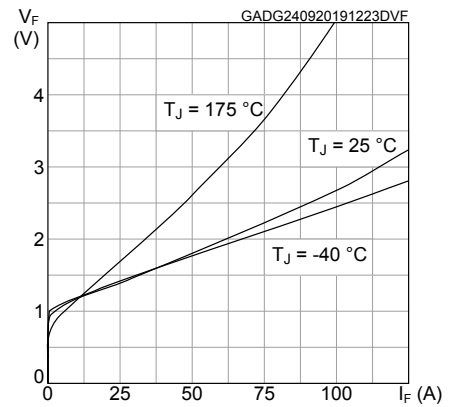

Figure 11. Normalized VGE(th) vs junction temperature

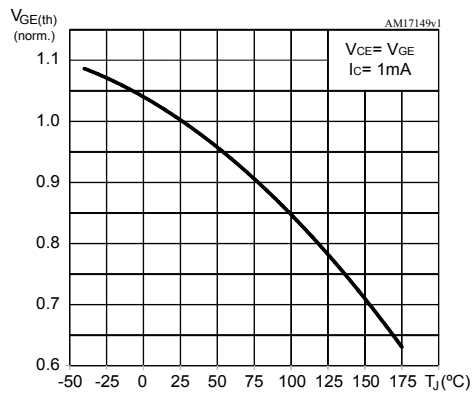

Figure 12. Normalized V(BR)CES vs junction temperature

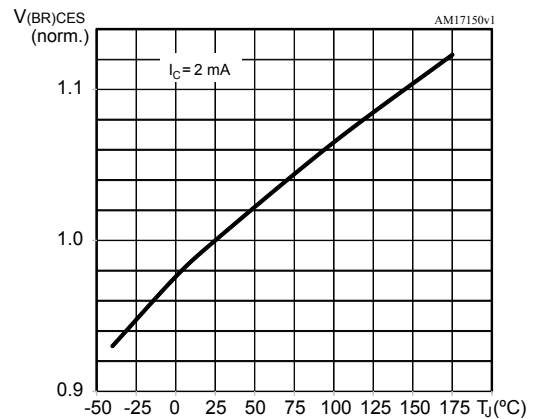

Figure 13. Capacitance variations

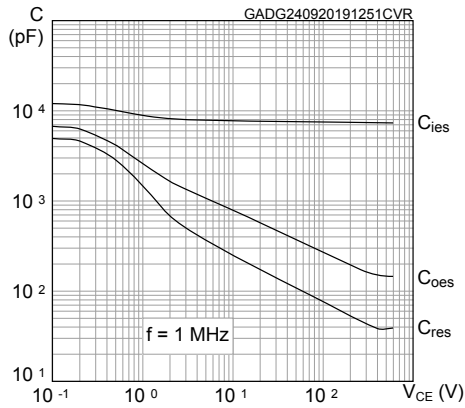

Figure 14. Gate charge vs gate-emitter voltage

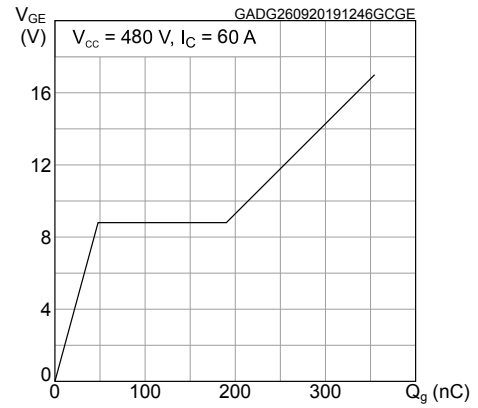

Figure 15. Switching energy vs collector current

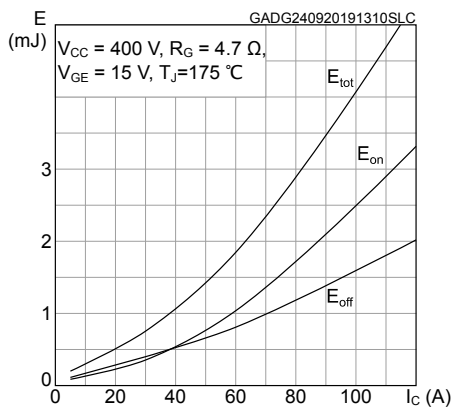

Figure 16. Switching energy vs temperature

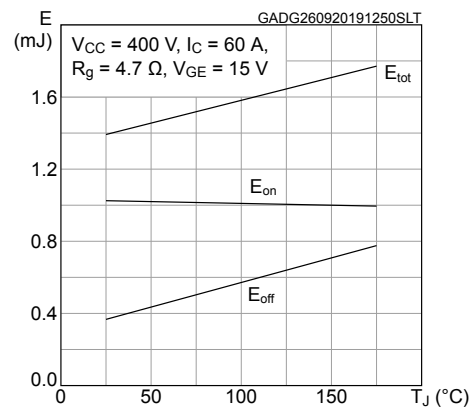

Figure 17. Switching energy vs collector emitter voltage

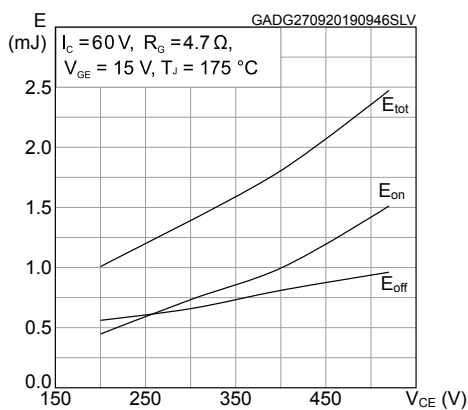

Figure 18. Switching energy vs gate resistance

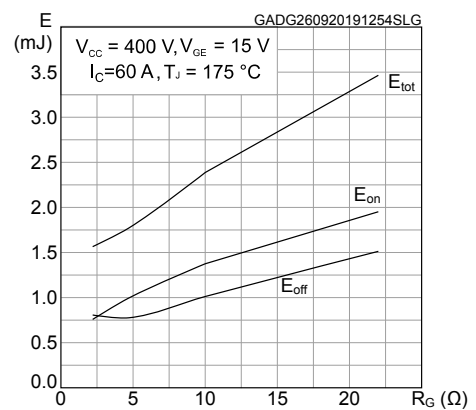

Figure 19. Switching times vs collector current

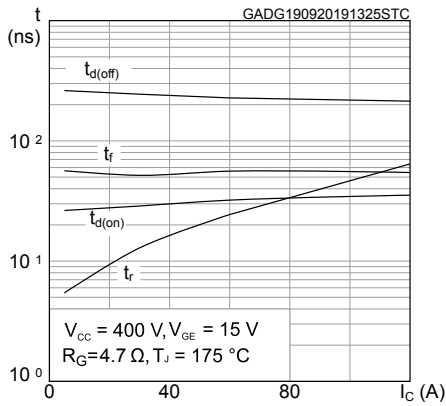

Figure 20. Switching times vs gate resistance

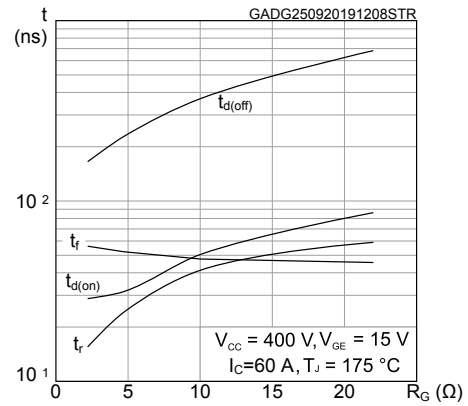

Figure 21. Reverse recovery current vs diode current slope

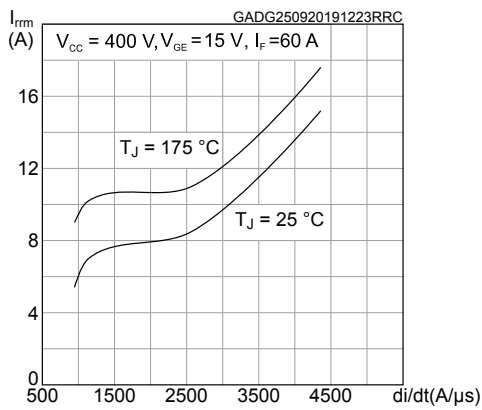

Figure 22. Reverse recovery time vs diode current slope

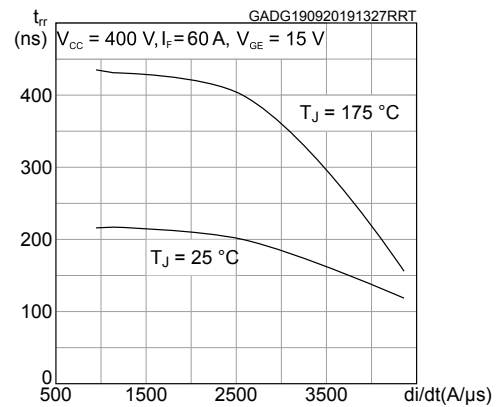

Figure 23. Reverse recovery charge vs diode current slope

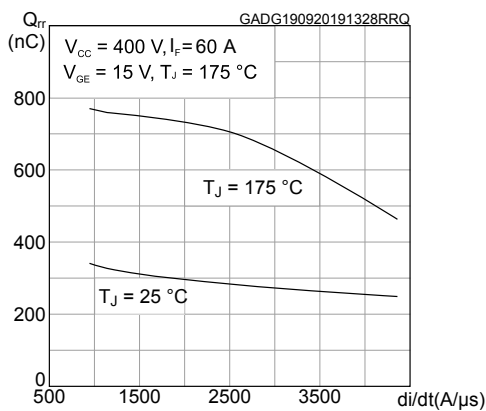

Figure 24. Reverse recovery energy vs diode current slope

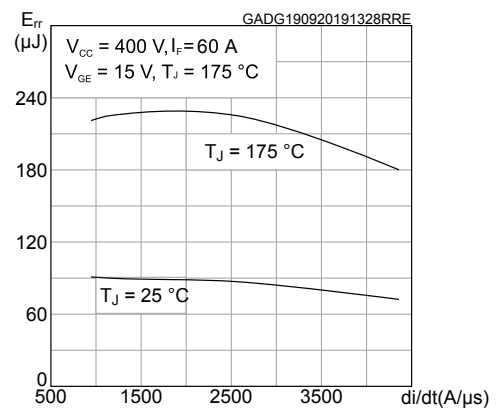

Figure 25. Thermal impedance for IGBT

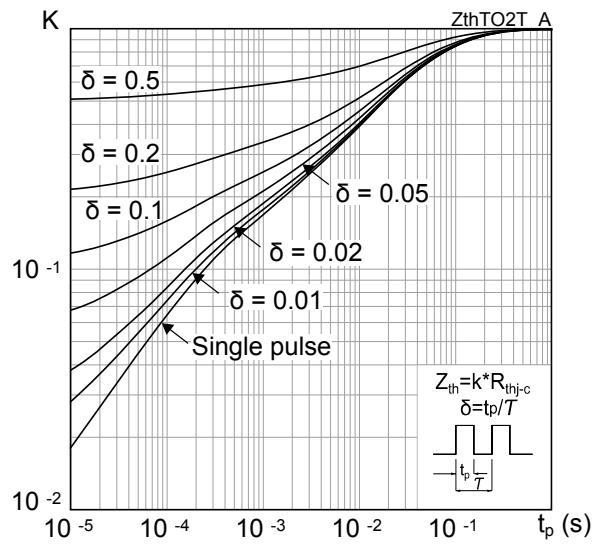
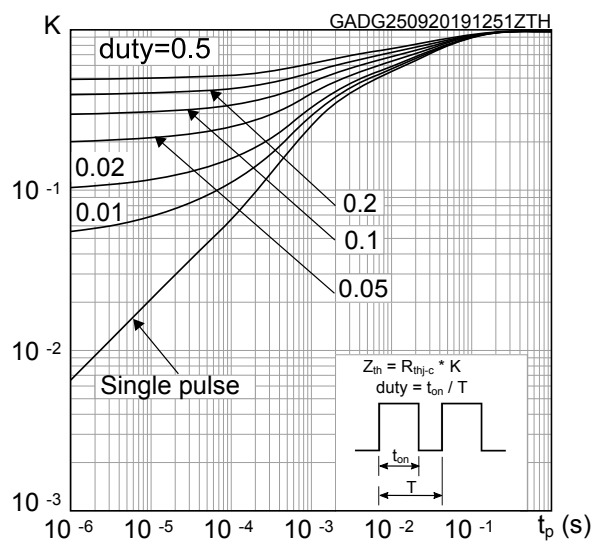
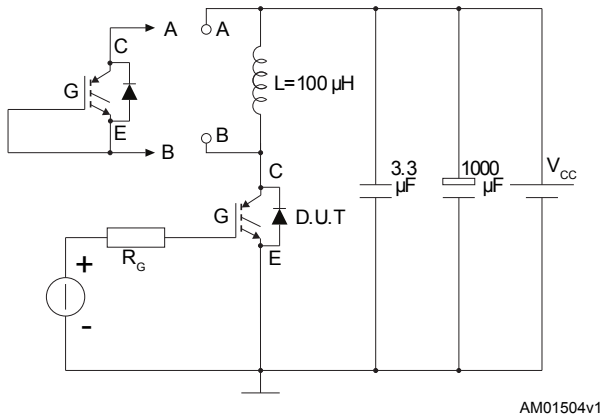
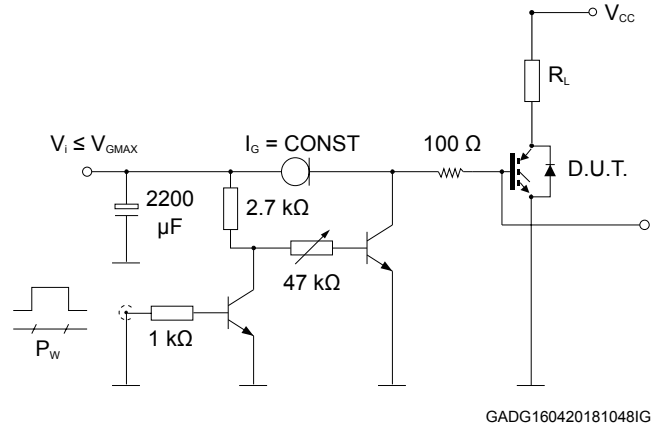
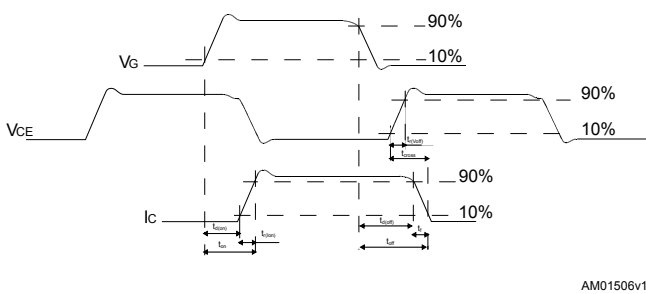
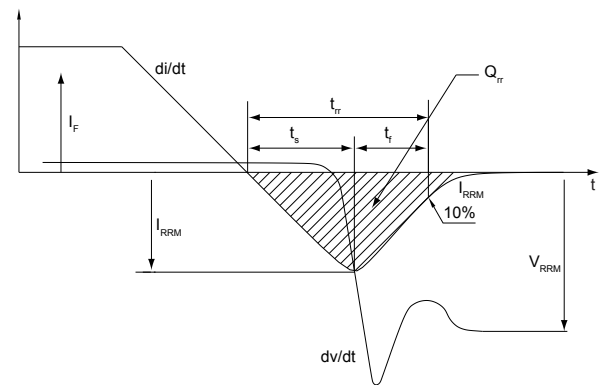

Figure 26. Thermal impedance for diode



3 Test circuits

Figure 27. Test circuit for inductive load switching

Figure 28. Gate charge test circuit

Figure 29. Switching waveform

Figure 30. Diode reverse recovery waveform

4 Package information

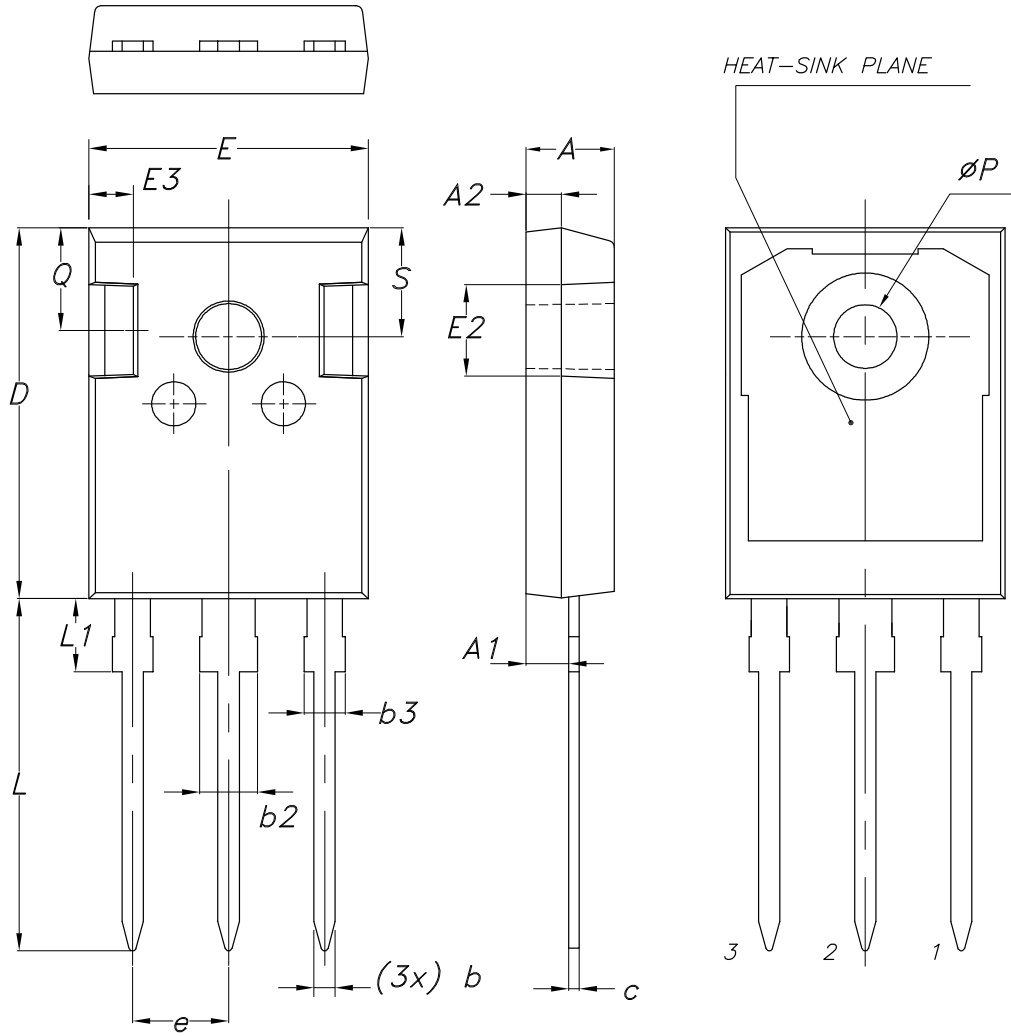
In order to meet environmental requirements, ST offers these devices in different grades of **ECOPACK** packages, depending on their level of environmental compliance. ECOPACK specifications, grade definitions and product status are available at: www.st.com. ECOPACK is an ST trademark.

4.1 TO-247 long leads package information

Figure 31. TO-247 long leads package outline



8463846_2_F

Table 7. TO-247 long leads package mechanical data

Dim.	mm		
	Min.	Typ.	Max.
A	4.90	5.00	5.10
A1	2.31	2.41	2.51
A2	1.90	2.00	2.10
b	1.16		1.26
b2			3.25
b3			2.25
c	0.59		0.66
D	20.90	21.00	21.10
E	15.70	15.80	15.90
E2	4.90	5.00	5.10
E3	2.40	2.50	2.60
e	5.34	5.44	5.54
L	19.80	19.92	20.10
L1			4.30
P	3.50	3.60	3.70
Q	5.60		6.00
S	6.05	6.15	6.25

Revision history

Table 8. Document revision history

Date	Version	Changes
01-Oct-2019	1	First release.
23-Oct-2019	2	Modified Table 3. Static characteristics .

Contents

1	Electrical ratings	2
2	Electrical characteristics	3
2.1	Electrical characteristics (curves)	5
3	Test circuits	10
4	Package information	11
4.1	TO-247 long leads package information	11
	Revision history	14

IMPORTANT NOTICE – PLEASE READ CAREFULLY

STMicroelectronics NV and its subsidiaries (“ST”) reserve the right to make changes, corrections, enhancements, modifications, and improvements to ST products and/or to this document at any time without notice. Purchasers should obtain the latest relevant information on ST products before placing orders. ST products are sold pursuant to ST’s terms and conditions of sale in place at the time of order acknowledgement.

Purchasers are solely responsible for the choice, selection, and use of ST products and ST assumes no liability for application assistance or the design of Purchasers’ products.

No license, express or implied, to any intellectual property right is granted by ST herein.

Resale of ST products with provisions different from the information set forth herein shall void any warranty granted by ST for such product.

ST and the ST logo are trademarks of ST. For additional information about ST trademarks, please refer to www.st.com/trademarks. All other product or service names are the property of their respective owners.

Information in this document supersedes and replaces information previously supplied in any prior versions of this document.

© 2019 STMicroelectronics – All rights reserved