

V Series

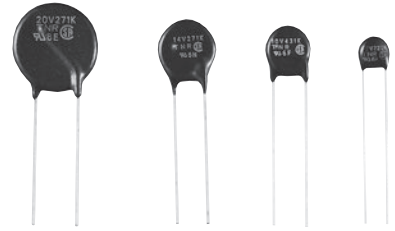

◆FEATURES

- Excellent voltage non-linear coefficient.
Low clamping voltage.
- Symmetrical V-I characteristics (No polarity).
- Fast response.
- Stable characteristics against repeated surges.
- Superior temperature characteristics.
- High reliability
- UL, CSA and VDE recognized components
UL 1449 3rd File : E323623
CSA File : LR97864
VDE File : 118623
- Coating resin : UL94V-0

◆APPLICATIONS

- Protection for semiconductors from over voltage.
- Protection for electronic instruments from lightning surges.
- Absorption of on-off surges from motors and relays.

Operating Temperature Range: -40 to +85°C
Storage Temperature Range: -50 to +125°C

◆PART NUMBERING SYSTEM

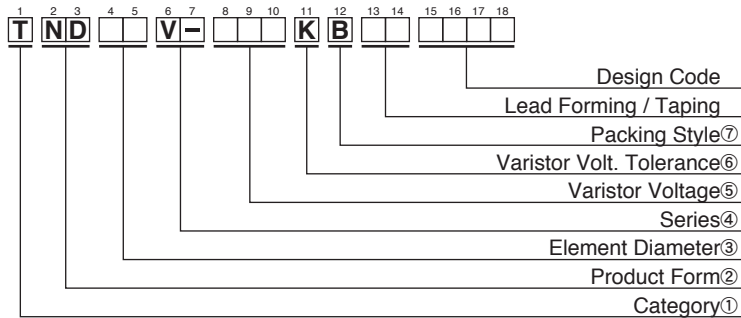

①Category	
T	Metal Oxide Varistors TNR

②Product Form	
ND	Disk Type

③Element Diameter	
05	φ 5 mm
07	φ 7 mm
09	φ 9 mm
10	φ 10 mm
12	φ 12 mm
14	φ 14 mm
20	φ 20 mm

④Series	
V-	V Series

⑤Varistor Voltage	
The first two digits are significant figures and the third one denotes the number of following zeros.	

⑥Varistor Volt. Tolerance	
K	±10%

⑦Packing Style	
B	Bulk
T	Taping



V Series

◆STANDARD RATINGS (Type 5V)

Part Number	Previous Part Number (Just for your reference)	Maximum Ratings					Max. Clamping Voltage		Capacitance Typical @1kHz (pF)	Varistor Voltage V _{0.1mA} (V)	T Max. (mm)
		Max. Allowable Voltage		Max. Peak Current	Max. Energy	Rated Wattage	(A)	(V)			
		AC (Vrms)	DC (V)	8/20μs(A)	2ms(J)	(W)					
TND05V-180KB00AAA0	TNR5V180K	11	14	250A/1 time 125A/2 times	0.4	0.01	1	40	2540	18 (16~ 20)	4.5
TND05V-220KB00AAA0	TNR5V220K	14	18		0.5			48	2090	22 (20~ 24)	
TND05V-270KB00AAA0	TNR5V270K	17	22		0.7			60	1790	27 (24~ 30)	
TND05V-330KB00AAA0	TNR5V330K	20	26		0.8			73	1480	33 (30~ 36)	
TND05V-390KB00AAA0	TNR5V390K	25	30		0.9			86	1310	39 (35~ 43)	
TND05V-470KB00AAA0	TNR5V470K	30	37		1.1			104	1140	47 (42~ 52)	
TND05V-560KB00AAA0	TNR5V560K	35	44		1.3			123	1000	56 (50~ 62)	
TND05V-680KB00AAA0	TNR5V680K	40	55	1.6	150	870	68 (61~ 75)				
TND05V-820KB00AAA0	TNR5V820K	50	65	800A/1 time 600A/2 times	2.5	0.1	5	145	400	82 (74~ 90)	4.1
TND05V-101KB00AAA0	TNR5V101K	60	85		3			175	350	100 (90~110)	4.3
TND05V-121KB00AAA0	TNR5V121K	75	100		3.5			210	310	120 (108~132)	4.5
TND05V-151KB00AAA0	TNR5V151K	95	125		4.5			260	270	150 (135~165)	4.8
TND05V-181KB00AAA0	TNR5V181K	110	145		5			325	190	180 (162~198)	4.3
TND05V-201KB00AAA0	TNR5V201K	130	170		6			355	110	200 (185~225)	4.4
TND05V-221KB00AAA0	TNR5V221K	140	180		6.5			380	110	220 (198~242)	4.5
TND05V-241KB00AAA0	TNR5V241K	150	200		7.5			415	100	240 (216~264)	4.6
TND05V-271KB00AAA0	TNR5V271K	175	225		8			475	90	270 (247~303)	4.8
TND05V-331KB00AAA0	TNR5V331K	210	270		9.5			570	80	330 (297~363)	5.1
TND05V-361KB00AAA0	TNR5V361K	230	300		11			620	80	360 (324~396)	5.3
TND05V-391KB00AAA0	TNR5V391K	250	320		12			675	70	390 (351~429)	5.4
TND05V-431KB00AAA0	TNR5V431K	275	350		13.5			745	70	430 (387~473)	5.6
TND05V-471KB00AAA0	TNR5V471K	300	385		15			810	60	470 (423~517)	5.8

◆DIMENSIONS [mm]

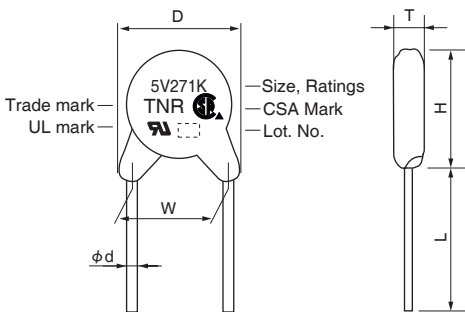

D Max.	H Max.	T Max.	L Min.	ϕd ±0.05	W ±1.0
7.5	10.0	Ref. to RATINGS	20.0	0.6	5.0

◆V-I CURVE

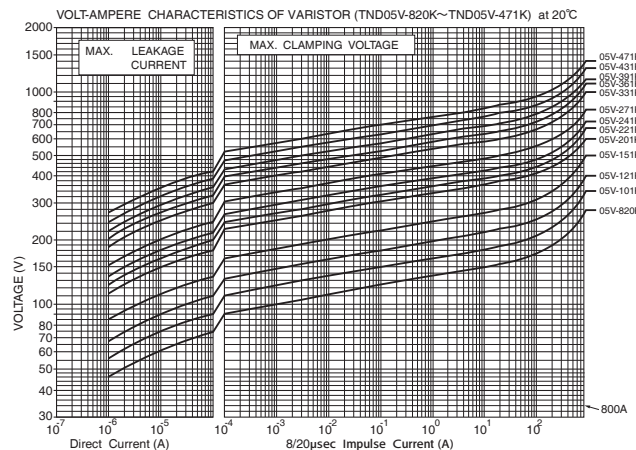
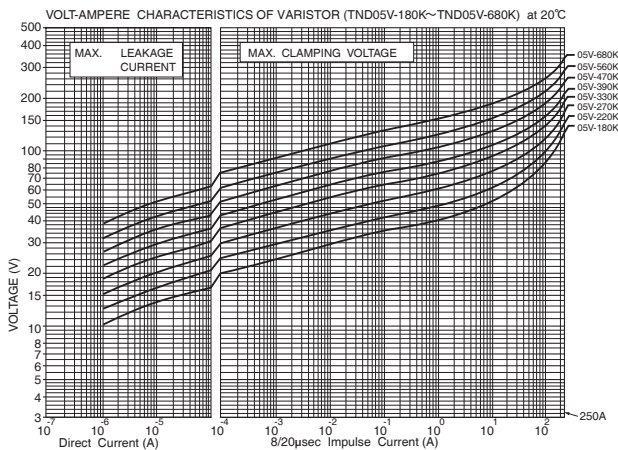

V Series

◆STANDARD RATINGS (Type 7V)

Part Number	Previous Part Number (Just for your reference)	Maximum Ratings					Max. Clamping Voltage		Capacitance Typical @1kHz (pF)	Varistor Voltage V CmA (V)	T Max. (mm)
		Max. Allowable Voltage		Max. Peak Current	Max. Energy	Rated Wattage	(A)	(V)			
		AC (Vrms)	DC (V)	8/20μs(A)	2ms(J)						
TND07V-150KB00AAA0	TNR7V150K	8	12	500A/1 time	0.7	0.02	2.5	30	4600	15 (13~ 17)	4.5
TND07V-180KB00AAA0	TNR7V180K	11	14		0.9			36	3800	18 (16~ 20)	4.5
TND07V-220KB00AAA0	TNR7V220K	14	18		1.1			43	3200	22 (20~ 24)	4.6
TND07V-270KB00AAA0	TNR7V270K	17	22		1.3			53	2800	27 (24~ 30)	4.7
TND07V-330KB00AAA0	TNR7V330K	20	26	250A/2 times	1.6	0.02	2.5	65	2300	33 (30~ 36)	4.9
TND07V-390KB00AAA0	TNR7V390K	25	30		1.9			77	2100	39 (35~ 43)	4.8
TND07V-470KB00AAA0	TNR7V470K	30	37		2.3			93	1900	47 (42~ 52)	4.9
TND07V-560KB00AAA0	TNR7V560K	35	44		2.7			110	1700	56 (50~ 62)	5.0
TND07V-680KB00AAA0	TNR7V680K	40	55	3.3	135	1500	68 (61~ 75)	5.2			
TND07V-820KB00AAA0	TNR7V820K	50	65	1750A/1 time	5	0.25	10	135	800	82 (74~ 90)	4.1
TND07V-101KB00AAA0	TNR7V101K	60	85		6			165	700	100 (90~110)	4.3
TND07V-121KB00AAA0	TNR7V121K	75	100		7			200	650	120 (108~132)	4.5
TND07V-151KB00AAA0	TNR7V151K	95	125		9			250	600	150 (135~165)	4.8
TND07V-181KB00AAA0	TNR7V181K	110	145	1250A/2 times	11	0.25	10	300	430	180 (162~198)	4.3
TND07V-201KB00AAA0	TNR7V201K	130	170		12.5			340	250	200 (185~225)	4.4
TND07V-221KB00AAA0	TNR7V221K	140	180		13.5			360	230	220 (198~242)	4.5
TND07V-241KB00AAA0	TNR7V241K	150	200		15			395	210	240 (216~264)	4.6
TND07V-271KB00AAA0	TNR7V271K	175	225	17	455	190	270 (247~303)	4.8			
TND07V-331KB00AAA0	TNR7V331K	210	270	20	545	160	330 (297~363)	5.1			
TND07V-361KB00AAA0	TNR7V361K	230	300	23	595	150	360 (324~396)	5.3			
TND07V-391KB00AAA0	TNR7V391K	250	320	25	650	140	390 (351~429)	5.4			
TND07V-431KB00AAA0	TNR7V431K	275	350	27.5	710	130	430 (387~473)	5.6			
TND07V-471KB00AAA0	TNR7V471K	300	385	30	775	120	470 (423~517)	5.8			
TND07V-511KB00AAA0	TNR7V511K	320	410	32	845	110	510 (459~561)	6.0			

◆DIMENSIONS [mm]

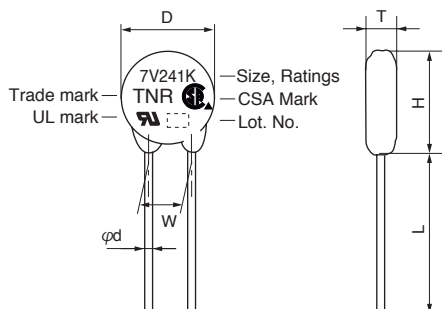

D Max.	H Max.	T Max.	L Min.	φd ±0.05	W ±1.0
8.5	11.5	Ref. to RATINGS	20.0	0.6	5.0

V Series

◆V-I CURVE (Type 7V)

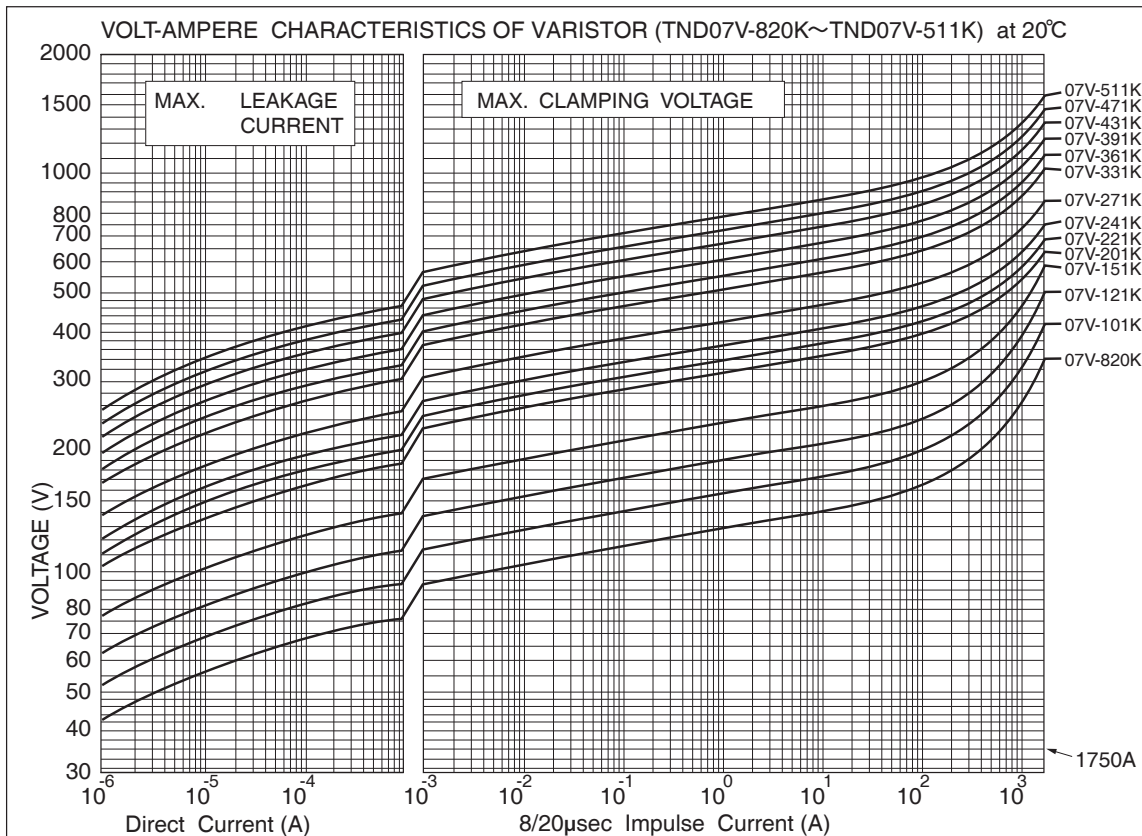
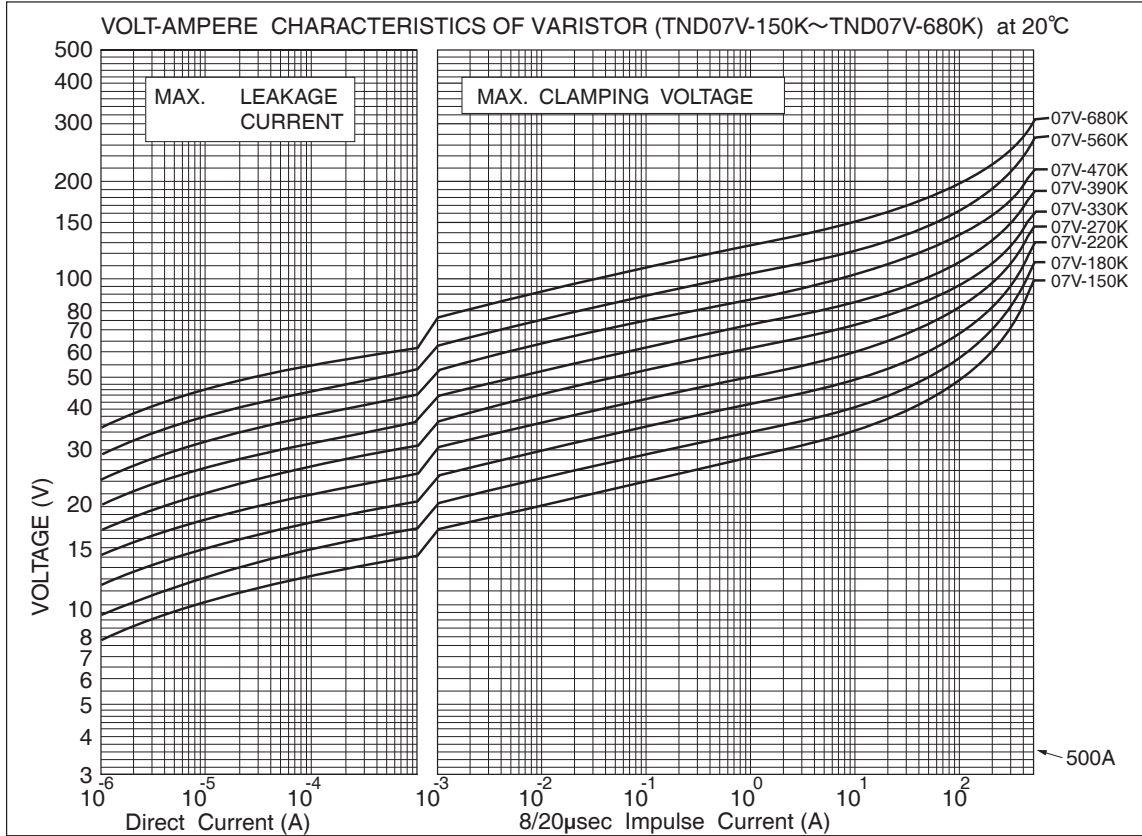

V Series

◆ RATINGS (Type 9V)

Part Number	Previous Part Number (Just for your reference)	Maximum Ratings					Max. Clamping Voltage		Capacitance Typical @1kHz (pF)	Varistor Voltage V CmA (V)	T Max. (mm)	
		Max. Allowable Voltage		Max. Peak Current	Max. Energy	Rated Wattage	(A)	(V)				
		AC (Vrms)	DC (V)	8/20μs(A)	2ms(J)							(W)
TND09V-150KB00AAA0	TNR9V150K	8	12	800A/1 time	2.0	0.02	5	30	9600	15 (13~ 17)	3.8	
TND09V-180KB00AAA0	TNR9V180K	11	14		2.2			36	8000	18 (16~ 20)	3.8	
TND09V-220KB00AAA0	TNR9V220K	14	18		2.6			43	7000	22 (20~ 24)	4.0	
TND09V-270KB00AAA0	TNR9V270K	17	22		3.2			53	6000	27 (24~ 30)	4.2	
TND09V-330KB00AAA0	TNR9V330K	20	26	400A/2 times	4.0	0.02	5	65	5000	33 (30~ 36)	4.5	
TND09V-390KB00AAA0	TNR9V390K	25	30		4.7			77	4500	39 (35~ 43)	4.0	
TND09V-470KB00AAA0	TNR9V470K	30	37		5.6			93	4000	47 (42~ 52)	4.2	
TND09V-560KB00AAA0	TNR9V560K	35	44		6.7			110	3500	56 (50~ 62)	4.4	
TND09V-680KB00AAA0	TNR9V680K	40	55	8.2	135	3200	68 (61~ 75)	4.5				
TND09V-820KB00AAA0	TNR9V820K	50	65	10	170	2500	82 (74~ 90)	3.8				
TND09V-101KB00AAA0	TNR9V101K	60	85	12	200	1600	100 (90~110)	3.9				
TND09V-121KB00AAA0	TNR9V121K	75	100	14.5	250	1400	120 (108~132)	4.1				
TND09V-151KB00AAA0	TNR9V151K	95	125	18	300	1300	150 (135~165)	4.4				
TND09V-181KB00AAA0	TNR9V181K	110	145	22	340	900	180 (162~198)	4.0				
TND09V-201KB00AAA0	TNR9V201K	130	170	25	360	500	200 (185~225)	4.1				
TND09V-221KB00AAA0	TNR9V221K	140	180	3000A/1 time	27.5	0.25	25	450	450	220 (198~242)	4.2	
TND09V-241KB00AAA0	TNR9V241K	150	200		30			395	400	240 (216~264)	4.3	
TND09V-271KB00AAA0	TNR9V271K	175	225		2000A/2 times			35	455	350	270 (247~303)	4.5
TND09V-331KB00AAA0	TNR9V331K	210	270					42	545	300	330 (297~363)	4.8
TND09V-361KB00AAA0	TNR9V361K	230	300	45	595	280	360 (324~396)	5.0				
TND09V-391KB00AAA0	TNR9V391K	250	320	50	650	260	390 (351~429)	5.1				
TND09V-431KB00AAA0	TNR9V431K	275	350	55	710	240	430 (387~473)	5.3				
TND09V-471KB00AAA0	TNR9V471K	300	385	60	775	220	470 (423~517)	5.6				
TND09V-511KB00AAA0	TNR9V511K	320	410	67	845	210	510 (459~561)	5.8				

◆ DIMENSIONS [mm]

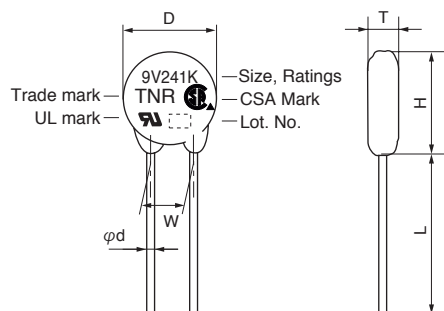

D Max.	H Max.	T Max.	L Min.	φd ±0.05	W ±1.0
11.5	14.5	Ref. to RATINGS	20.0	0.6	5.0

V Series

◆V-I CURVE (Type 9V)

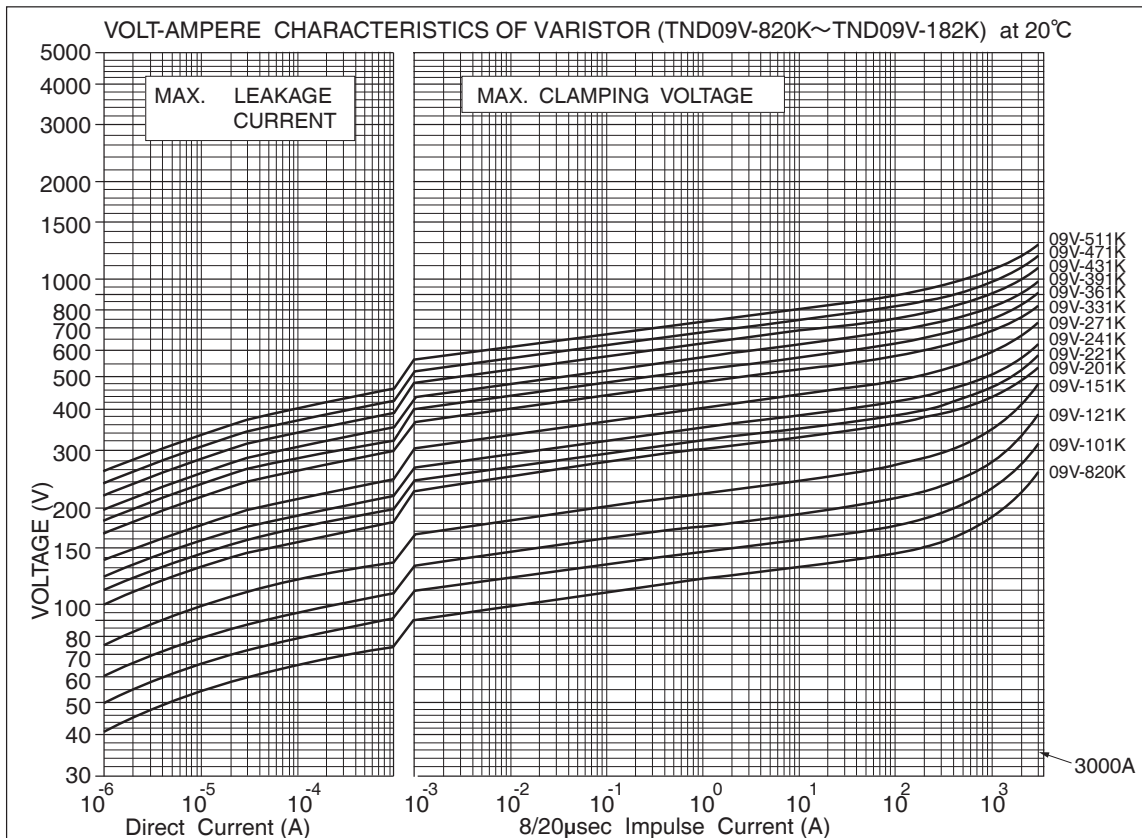
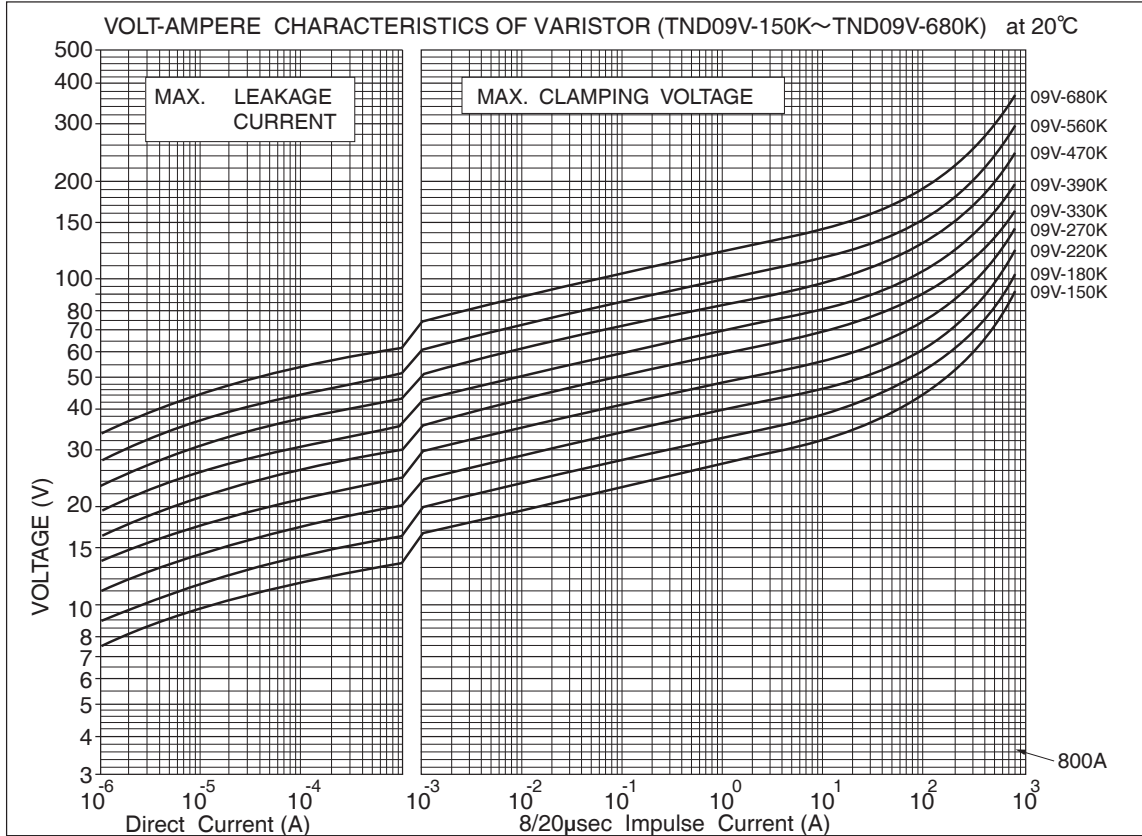

V Series

◆ RATINGS (Type 10V)

Part Number	Previous Part Number (Just for your reference)	Maximum Ratings					Max. Clamping Voltage	Capacitance Typical @1kHz	Varistor Voltage V CmA	T Max.	E ±1.0	W2 reference
		Max. Allowable Voltage		Max. Peak Current	Max. Energy	Rated Wattage						
		AC (Vrms)	DC (V)	8/20μs(A)	2ms(J)	(W)						
TND10V-150KB00AAA0	TNR10V150K	8	12		2.0		30	9600	15 (13~ 17)	4.5	1.0	7.6
TND10V-180KB00AAA0	TNR10V180K	11	14		2.2		36	8000	18 (16~ 20)	4.6	1.1	7.6
TND10V-220KB00AAA0	TNR10V220K	14	18		2.6		43	7000	22 (20~ 24)	4.7	1.2	7.6
TND10V-270KB00AAA0	TNR10V270K	17	22	1000A/1 time	3.2		53	6000	27 (24~ 30)	4.8	1.3	7.6
TND10V-330KB00AAA0	TNR10V330K	20	26		4.0	0.05	65	5000	33 (30~ 36)	5.0	1.5	7.6
TND10V-390KB00AAA0	TNR10V390K	25	30	500A/2 times	4.7		77	4500	39 (35~ 43)	4.9	1.3	7.6
TND10V-470KB00AAA0	TNR10V470K	30	37		5.6		93	4000	47 (42~ 52)	5.0	1.4	7.6
TND10V-560KB00AAA0	TNR10V560K	35	44		6.7		110	3500	56 (50~ 62)	5.1	1.6	7.7
TND10V-680KB00AAA0	TNR10V680K	40	55		8.2		135	3200	68 (61~ 75)	5.3	1.8	7.7
TND10V-820KB00AAA0	TNR10V820K	50	65		10		135	1700	82 (74~ 90)	4.5	1.1	7.6
TND10V-101KB00AAA0	TNR10V101K	60	85		12		165	1600	100 (90~ 110)	4.7	1.3	7.6
TND10V-121KB00AAA0	TNR10V121K	75	100		14.5		200	1400	120 (108~ 132)	4.9	1.4	7.6
TND10V-151KB00AAA0	TNR10V151K	95	125		18		250	1300	150 (135~ 165)	5.2	1.7	7.7
TND10V-181KB00AAA0	TNR10V181K	110	145		22		300	900	180 (162~ 198)	4.7	1.1	7.6
TND10V-201KB00AAA0	TNR10V201K	130	170		25		340	500	200 (185~ 225)	4.8	1.2	7.6
TND10V-221KB00AAA0	TNR10V221K	140	180		27.5		360	450	220 (198~ 242)	4.9	1.3	7.6
TND10V-241KB00AAA0	TNR10V241K	150	200		30		395	400	240 (216~ 264)	5.0	1.3	7.6
TND10V-271KB00AAA0	TNR10V271K	175	225		35		455	350	270 (247~ 303)	5.2	1.4	7.6
TND10V-331KB00AAA0	TNR10V331K	210	270		42		545	300	330 (297~ 363)	5.5	1.6	7.7
TND10V-361KB00AAA0	TNR10V361K	230	300		45		595	280	360 (324~ 396)	5.7	1.8	7.7
TND10V-391KB00AAA0	TNR10V391K	250	320	3500A/1 time	50		650	260	390 (351~ 429)	5.8	1.9	7.7
TND10V-431KB00AAA0	TNR10V431K	275	350		55	0.4	710	240	430 (387~ 473)	6.0	2.0	7.8
TND10V-471KB00A◇A0	TNR10V471K□	300	385	2500A/2 times	60		775	220	470 (423~ 517)	6.2	2.1	7.8
TND10V-511KB00A◇A0	TNR10V511K□	320	410		67		845	210	510 (459~ 561)	6.4	2.3	7.8
TND10V-561KB00A◇A0	TNR10V561K□	350	460		67		922	195	560 (504~ 616)	6.7	2.5	7.9
TND10V-621KB00A◇A0	TNR10V621K□	385	505		67		1025	180	620 (558~ 682)	7.1	2.7	8.0
TND10V-681KB00A◇A0	TNR10V681K□	420	560		67		1120	165	680 (612~ 748)	7.4	2.9	8.0
TND10V-751KB00A◇A0	TNR10V751K□	460	615		70		1240	150	750 (675~ 825)	7.8	3.1	8.1
TND10V-821KB00A◇A0	TNR10V821K□	510	670		80		1355	140	820 (738~ 902)	8.1	3.4	8.2
TND10V-911KB00A◇A0	TNR10V911K□	550	745		90		1500	125	910 (819~1001)	8.6	3.7	8.4
TND10V-102KB00A◇A0	TNR10V102K□	625	825		100		1650	115	1000 (900~1100)	9.1	4.0	8.5
TND10V-112KB00A◇A0	TNR10V112K□	680	895		110		1815	105	1100 (990~1210)	9.7	4.4	8.7
TND10V-122KB00A◇A0	TNR10V122K□	720	980		120		1950	95	1200 (1080~1320)	10.5	4.7*	8.9**
TND10V-152KB00A◇A0	TNR10V152K□	860	1220		150		2440	85	1500 (1350~1650)	12.4	5.8*	9.5**
TND10V-182KB00A◇A0	TNR10V182K□	1000	1465		183		2970	70	1800 (1700~1980)	14.4	6.9*	10.2**

*E±2 **W2±2

◆ DIMENSIONS [mm]

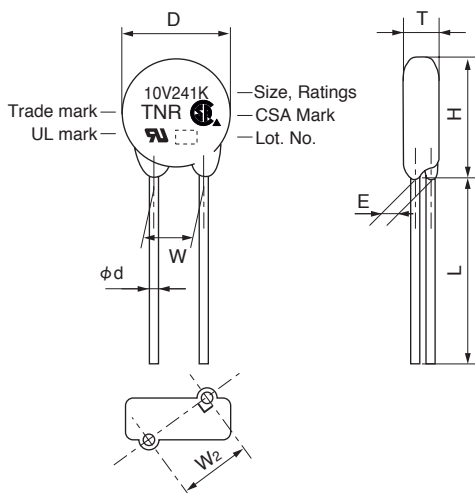

	◇	□
Standard	A	N/A
φ 10 IEC 62368-1:2014 G.8.2 conforming product	S	S

Part Number	D Max.	H Max.	T Max.	L Min.	φd ±0.05	W ±1.0
TND10V-150K to TND10V-511K	11.5	14.5	Ref. to RATINGS	20.0	0.8	7.5
TND10V-561K to TND10V-112K	12.5	15.5				
TND10V-122K to TND10V-182K	13.5	16.5				

- Common to standard product and IEC 62368-1:2014 G.8.2 conforming product
- The product with less than 620V of varistor voltage, taping is possible. Please refer to taping and forming specifications. The lead type parallel to a straight prepares, too.

V Series

◆V-I CURVE (Type 10V)

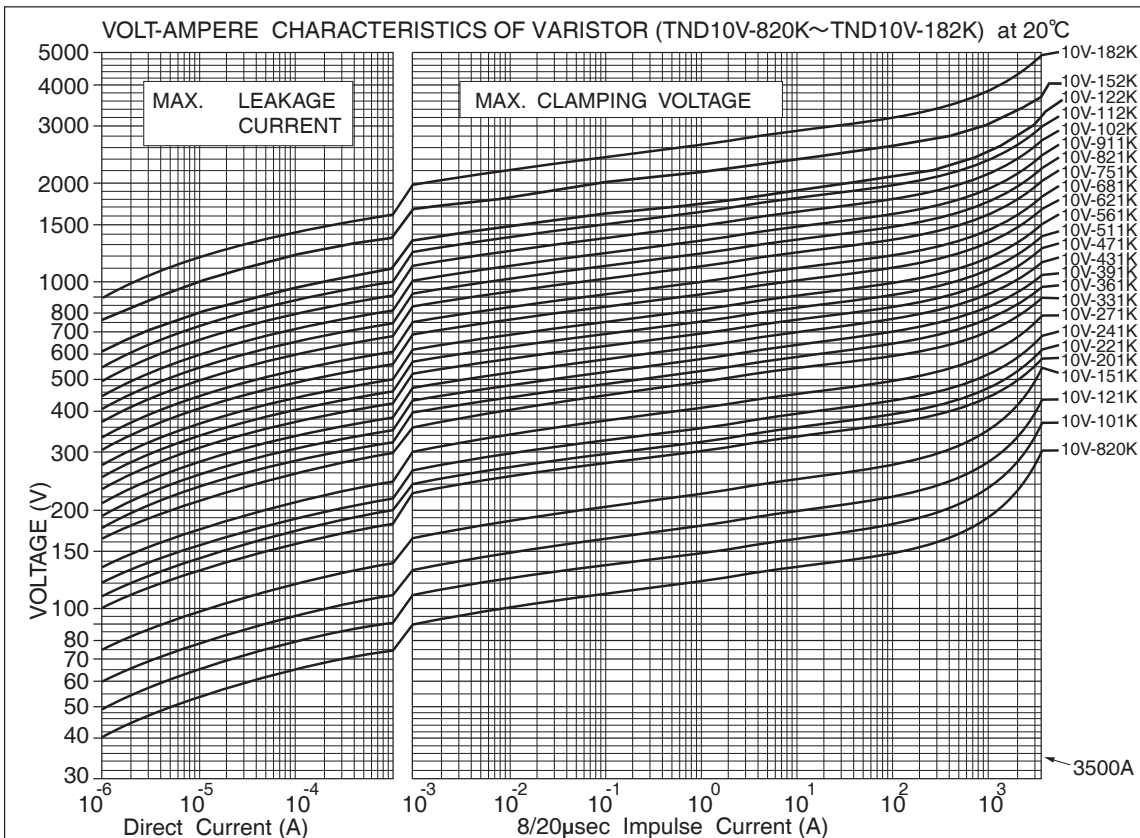
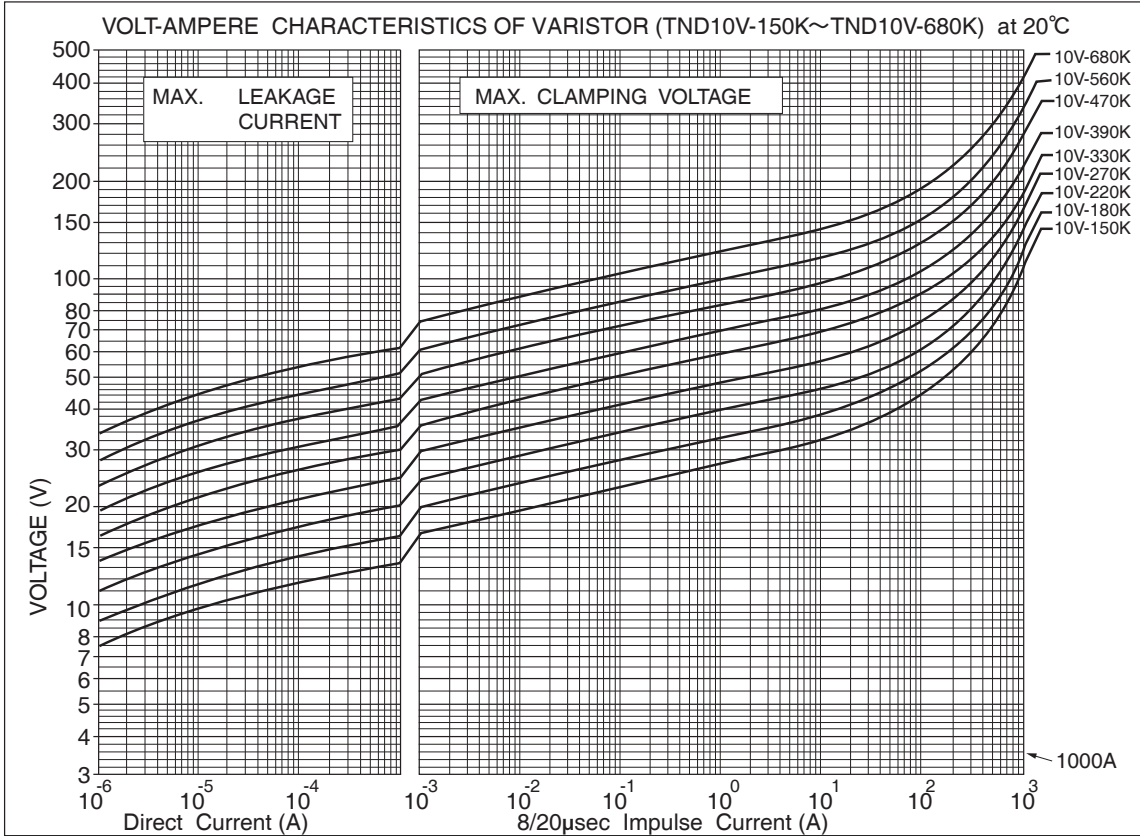

V Series

◆ RATINGS (Type 12V)

Part Number	Previous Part Number (Just for your reference)	Maximum Ratings					Max. Clamping Voltage		Capacitance Typical @1kHz	Varistor Voltage V CmA	T Max.	E ±1.0	W2 reference
		Max. Allowable Voltage		Max. Peak Current	Max. Energy	Rated Wattage	(A)	(V)					
		AC (Vrms)	DC (V)	8/20μs(A)	2ms(J)	(W)			(pF)	(V)	(mm)	(mm)	(mm)
TND12V-431KB00AAA0	TNR12V431K	275	350		55			710	375	430 (387 ~ 473)	6.0	2.0	7.8
TND12V-471KB00AAA0	TNR12V471K	300	385		60			775	345	470 (423 ~ 517)	6.2	2.1	7.8
TND12V-511KB00AAA0	TNR12V511K	320	410		67			845	330	510 (459 ~ 561)	6.4	2.3	7.8
TND12V-561KB00AAA0	TNR12V561K	350	460		67			922	305	560 (504 ~ 616)	6.7	2.5	7.9
TND12V-621KB00AAA0	TNR12V621K	385	505		67			1025	280	620 (558 ~ 682)	7.1	2.7	8.0
TND12V-681KB00AAA0	TNR12V681K	420	560	4,200A/1 time	67			1120	260	680 (612 ~ 748)	7.4	2.9	8.0
TND12V-751KB00AAA0	TNR12V751K	460	615		70	0.4	25	1240	235	750 (675 ~ 825)	7.8	3.1	8.1
TND12V-821KB00AAA0	TNR12V821K	510	670	3,000A/2 times	80			1355	220	820 (738 ~ 902)	8.1	3.4	8.2
TND12V-911KB00AAA0	TNR12V911K	550	745		90			1500	195	910 (819 ~ 1001)	8.6	3.7	8.4
TND12V-102KB00AAA0	TNR12V102K	625	825		100			1650	180	1000 (900 ~ 1100)	9.1	4.0	8.5
TND12V-112KB00AAA0	TNR12V112K	680	895		110			1815	165	1100 (990 ~ 1210)	9.7	4.4	8.7
TND12V-122KB00AAA0	TNR12V122K	720	980		120			1950	150	1200 (1080 ~ 1320)	10.5	4.7*	8.9**
TND12V-152KB00AAA0	TNR12V152K	860	1220		150			2440	135	1500 (1350 ~ 1650)	12.4	5.8*	9.5**
TND12V-182KB00AAA0	TNR12V182K	1000	1465		183			2970	110	1800 (1700 ~ 1980)	14.4	6.9*	10.2**

*E±2 **W2±2

◆ DIMENSIONS [mm]

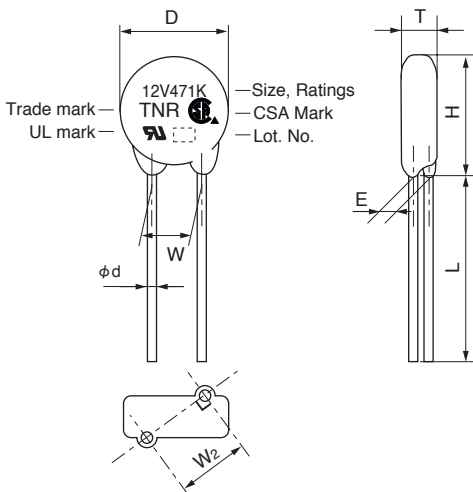

Part Number	D Max.	H Max.	T Max.	L Min.	φd ±0.05	W ±1.0
TND12V-431K to TND12V-102K	14.0	17.0	Ref. to RATINGS	20	0.8	7.5
TND12V-112K	15.0	18.0				
TND12V-122K	15.0	18.0				
TND12V-152K to TND12V-182K	16.0	19.0				

- The product with less than 620V of varistor voltage, taping is possible. Please refer to taping and forming specifications. The lead type parallel to a straight prepares, too.

V Series

◆V-I CURVE (Type 12V)

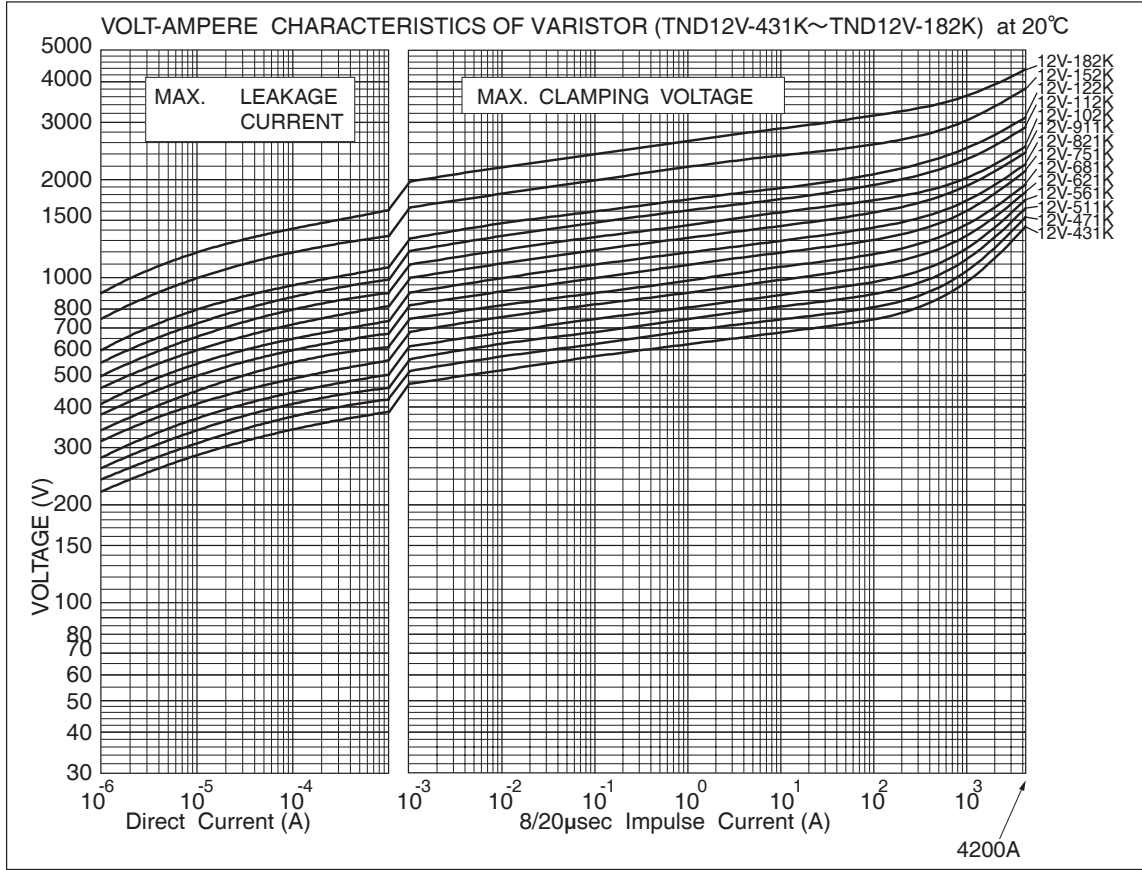

V Series

◆ RATINGS (Type 14V)

Part Number	Previous Part Number (Just for your reference)	Maximum Ratings					Max. Clamping Voltage	Capacitance Typical @1kHz	Varistor Voltage V CmA	T Max.	E ±1.0	W2 Reference
		Max. Allowable Voltage		Max. Peak Current	Max. Energy	Rated Wattage						
		AC (Vrms)	DC (V)	8/20µs(A)	2ms(J)	(W)						
TND14V-150KB00AAA0	TNR14V150K	8	12		3.6		30	19500	15 (13~ 17)	4.5	1.0	7.6
TND14V-180KB00AAA0	TNR14V180K	11	14		4.3		36	16500	18 (16~ 20)	4.6	1.1	7.6
TND14V-220KB00AAA0	TNR14V220K	14	18		5.3		43	13500	22 (20~ 24)	4.7	1.2	7.6
TND14V-270KB00AAA0	TNR14V270K	17	22	2000A/1 time	6.5		53	12000	27 (24~ 30)	4.8	1.4	7.6
TND14V-330KB00AAA0	TNR14V330K	20	26		7.9	0.1	65	10000	33 (30~ 36)	5.0	1.6	7.7
TND14V-390KB00AAA0	TNR14V390K	25	30	1000A/2 times	9.4		77	9000	39 (35~ 43)	4.9	1.3	7.6
TND14V-470KB00AAA0	TNR14V470K	30	37		11		93	8000	47 (42~ 52)	5.0	1.5	7.6
TND14V-560KB00AAA0	TNR14V560K	35	44		13		110	7500	56 (50~ 62)	5.1	1.7	7.7
TND14V-680KB00AAA0	TNR14V680K	40	55		16		135	6500	68 (61~ 75)	5.3	2.0	7.8
TND14V-820KB00AAA0	TNR14V820K	50	65		20		135	3000	82 (74~ 90)	4.5	1.1	7.6
TND14V-101KB00AAA0	TNR14V101K	60	85		25		165	2700	100 (90~ 110)	4.7	1.3	7.6
TND14V-121KB00AAA0	TNR14V121K	75	100		30		200	2500	120 (108~ 132)	4.9	1.4	7.6
TND14V-151KB00AAA0	TNR14V151K	95	125		37		250	2300	150 (135~ 165)	5.2	1.7	7.7
TND14V-181KB00AAA0	TNR14V181K	110	145		45		300	1650	180 (162~ 198)	4.7	1.1	7.6
TND14V-201KB00AAA0	TNR14V201K	130	170		50		340	950	200 (185~ 225)	4.8	1.2	7.6
TND14V-221KB00AAA0	TNR14V221K	140	180	6000A/1 time	55		360	850	220 (198~ 242)	4.9	1.3	7.6
TND14V-241KB00AAA0	TNR14V241K	150	200		60		395	800	240 (216~ 264)	5.0	1.4	7.6
TND14V-271KB00AAA0	TNR14V271K	175	225	5000A/2 times	70		455	700	270 (247~ 303)	5.2	1.5	7.6
TND14V-331KB00AAA0	TNR14V331K	210	270		80		545	600	330 (297~ 363)	5.5	1.7	7.7
TND14V-361KB00AAA0	TNR14V361K	230	300		90		595	550	360 (324~ 396)	5.7	1.8	7.7
TND14V-391KB00AAA0	TNR14V391K	250	320		100		650	500	390 (351~ 429)	5.8	1.9	7.7
TND14V-431KB00AAA0	TNR14V431K	275	350		110	0.6	710	460	430 (387~ 473)	6.0	2.1	7.8
TND14V-471KB00AAA0	TNR14V471K	300	385		125		775	420	470 (423~ 517)	6.2	2.2	7.8
TND14V-511KB00AAA0	TNR14V511K	320	410		136		845	390	510 (459~ 561)	6.4	2.4	7.9
TND14V-561KB00AAA0	TNR14V561K	350	460		136		922	360	560 (504~ 616)	6.7	2.6	7.9
TND14V-621KB00AAA0	TNR14V621K	385	505		136		1025	330	620 (558~ 682)	7.1	2.8	8.0
TND14V-681KB00AAA0	TNR14V681K	420	560		136		1120	310	680 (612~ 748)	7.4	3.0	8.1
TND14V-751KB00AAA0	TNR14V751K	460	615		150		1240	280	750 (675~ 825)	7.8	3.3	8.2
TND14V-821KB00AAA0	TNR14V821K	510	670	5000A/1 time	165		1355	250	820 (738~ 902)	8.1	3.5	8.3
TND14V-911KB00AAA0	TNR14V911K	550	745		180		1500	230	910 (819~1001)	8.6	3.9	8.5
TND14V-102KB00AAA0	TNR14V102K	625	825	4500A/2 times	200		1650	210	1000 (900~1100)	9.1	4.2	8.6
TND14V-112KB00AAA0	TNR14V112K	680	895		220		1815	190	1100 (990~1210)	9.7	4.6	8.8
TND14V-122KB00AAA0	TNR14V122K	720	980		240		1950	170	1200 (1080~1320)	10.5	4.9*	9.0**
TND14V-152KB00AAA0	TNR14V152K	860	1220		300		2440	150	1500 (1350~1650)	12.4	6.0*	9.6**
TND14V-182KB00AAA0	TNR14V182K	1000	1465		360		2970	120	1800 (1700~1980)	14.4	7.1*	10.3**

*E±2 **W2±2

◆ DIMENSIONS [mm]

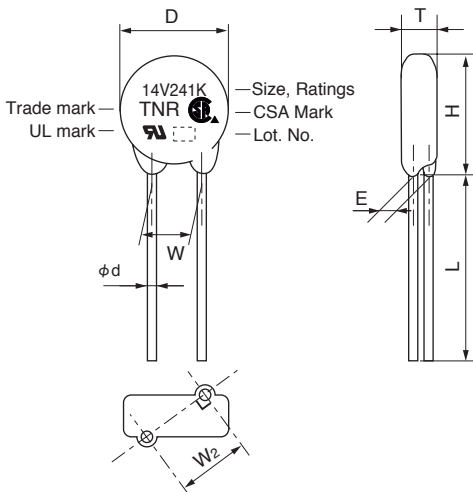

Part Number	D Max.	H Max.	T Max.	L Min.	φd ±0.05	W ±1.0
TND14V-150K to TND14V-511K	15.5	18.5	Ref. to RATINGS	20	0.8	7.5
TND14V-561K to TND14V-112K	16.0	19.0				
TND14V-122K to TND14V-182K	17.0	20.5				

● The product with less than 620V of varistor voltage, taping is possible. Please refer to taping and forming specifications. The lead type parallel to a straight prepares, too.

V Series

◆V-I CURVE (Type 14V)

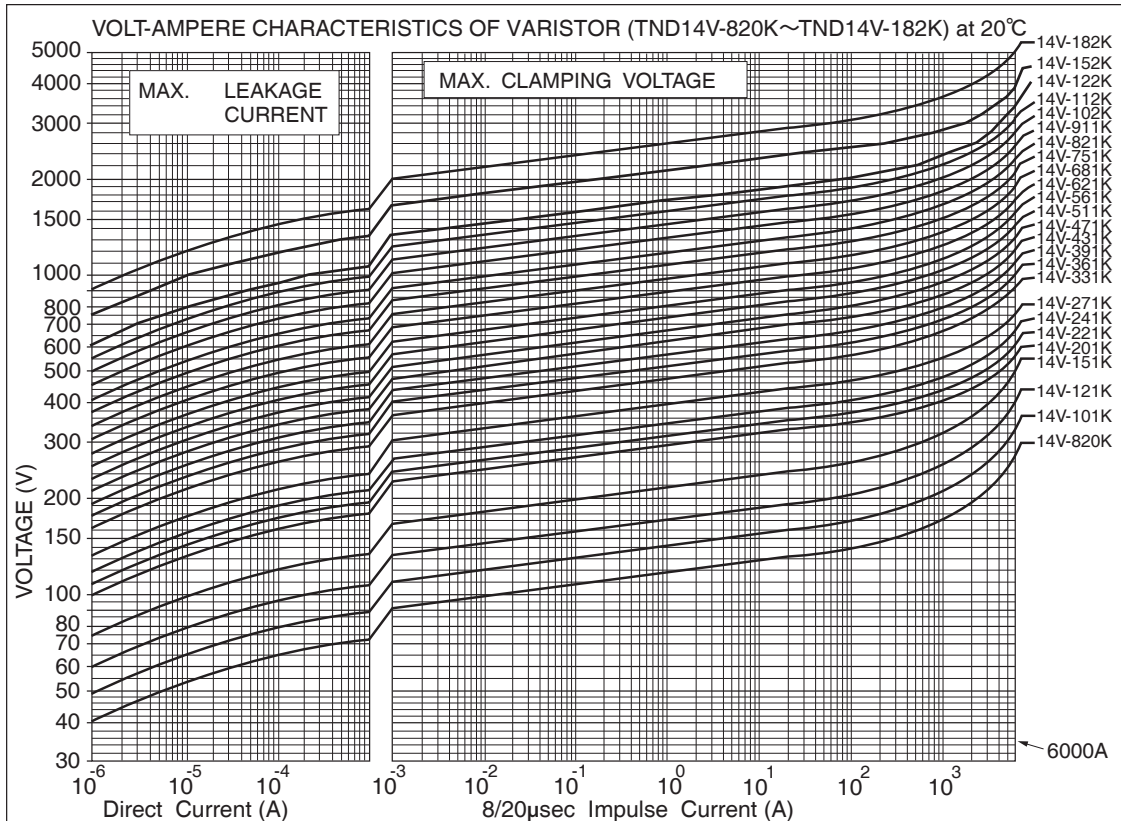
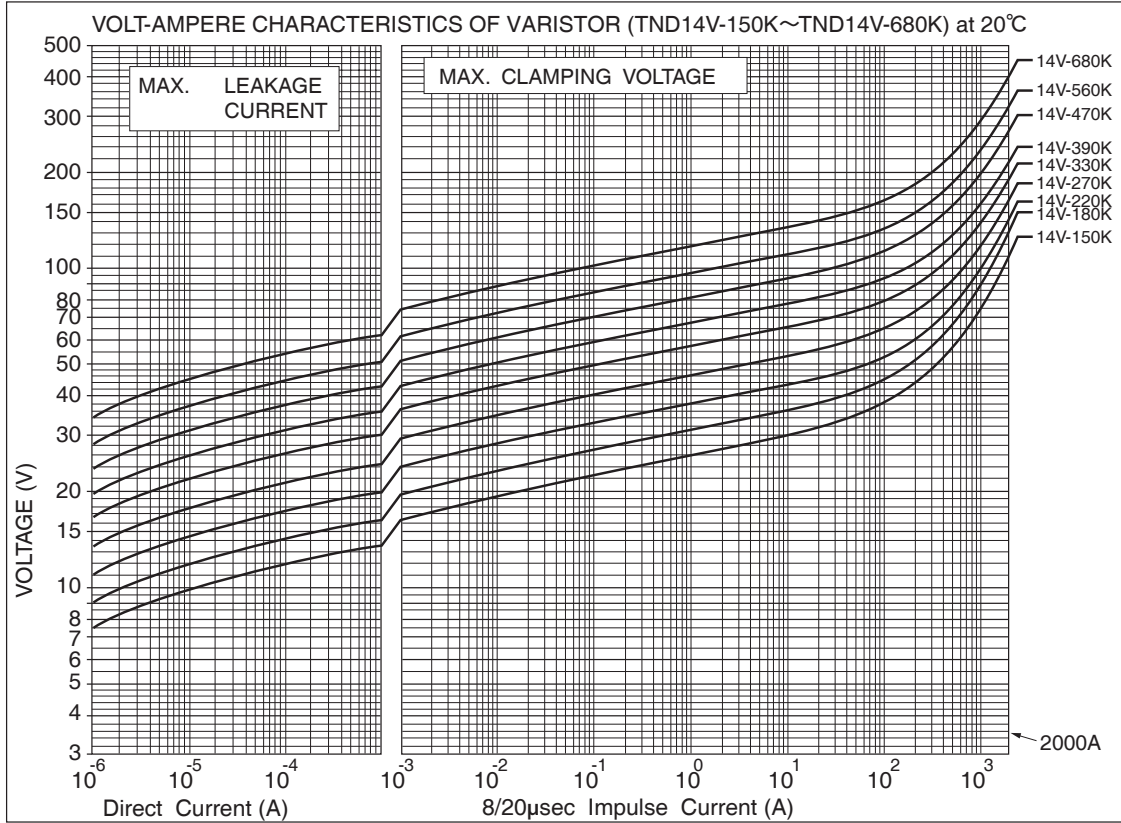



V Series

◆ RATINGS (Type 20V)

Part Number	Previous Part Number (Just for your reference)	Maximum Ratings					Max. Clamping Voltage (A) (V)	Capacitance Typical @1kHz (pF)	Varistor Voltage V CmA (V)	T Max. (mm)	E ±1.0 (mm)	W2 Reference (mm)	
		Max. Allowable Voltage		Max. Peak Current	Max. Energy	Rated Wattage							
		AC (Vrms)	DC (V)	8/20µs(A)	2ms(J)	(W)							
TND20V-180KB00AAA0	TNR20V180K	11	14	3000A/1 time	12	0.2	20	36	39000	18 (16~ 20)	5.1	1.1	10.1
TND20V-220KB00AAA0	TNR20V220K	14	18		14			43	33000	22 (20~ 24)	5.2	1.2	10.1
TND20V-270KB00AAA0	TNR20V270K	17	22		17			53	28000	27 (24~ 30)	5.3	1.4	10.1
TND20V-330KB00AAA0	TNR20V330K	20	26	2000A/2 times	21	1.0	100	65	24000	33 (30~ 36)	5.5	1.6	10.1
TND20V-390KB00AAA0	TNR20V390K	25	30		25			77	21000	39 (35~ 43)	5.5	1.3	10.1
TND20V-470KB00AAA0	TNR20V470K	30	37		30			93	19000	47 (42~ 52)	5.6	1.5	10.1
TND20V-560KB00AAA0	TNR20V560K	35	44	10000A/1 time	36	1.0	100	110	17000	56 (50~ 62)	5.7	1.7	10.1
TND20V-680KB00AAA0	TNR20V680K	40	55		44			135	15000	68 (61~ 75)	5.8	2.0	10.2
TND20V-820KB00AAA0	TNR20V820K	50	65		40			135	6700	82 (74~ 90)	4.9	1.2	10.1
TND20V-101KB00AAA0	TNR20V101K	60	85	50	165	6100	100 (90~ 110)	5.1	1.4	10.1			
TND20V-121KB00AAA0	TNR20V121K	75	100	60	200	5600	120 (108~ 132)	5.3	1.5	10.1			
TND20V-151KB00AAA0	TNR20V151K	95	125	75	250	5100	150 (135~ 165)	5.6	1.8	10.2			
TND20V-181KB00AAA0	TNR20V181K	110	145	85	300	3900	180 (162~ 198)	5.1	1.2	10.1			
TND20V-201KB00AAA0	TNR20V201K	130	170	100	340	2700	200 (185~ 225)	5.2	1.2	10.1			
TND20V-221KB00AAA0	TNR20V221K	140	180	7000A/2 times	110	1.0	100	360	2500	220 (198~ 242)	5.3	1.3	10.1
TND20V-241KB00AAA0	TNR20V241K	150	200		120			395	2300	240 (216~ 264)	5.4	1.4	10.1
TND20V-271KB00AAA0	TNR20V271K	175	225		135			455	2000	270 (247~ 303)	5.6	1.5	10.1
TND20V-331KB00AAA0	TNR20V331K	210	270	160	545	1700	330 (297~ 363)	5.9	1.7	10.1			
TND20V-361KB00AAA0	TNR20V361K	230	300	180	595	1500	360 (324~ 396)	6.1	1.9	10.2			
TND20V-391KB00AAA0	TNR20V391K	250	320	195	650	1400	390 (351~ 429)	6.2	2.0	10.2			
TND20V-431KB00AAA0	TNR20V431K	275	350	215	710	1300	430 (387~ 473)	6.4	2.1	10.2			
TND20V-471KB00AAA0	TNR20V471K	300	385	250	775	1200	470 (423~ 517)	6.6	2.3	10.3			
TND20V-511KB00AAA0	TNR20V511K	320	410	273	845	1100	510 (459~ 561)	6.8	2.4	10.3			
TND20V-561KB00AAA0	TNR20V561K	350	460	7500A/1 time	273	1.0	100	922	1000	560 (504~ 616)	7.1	2.6	10.3
TND20V-621KB00AAA0	TNR20V621K	385	505		273			1025	900	620 (558~ 682)	7.5	2.9	10.4
TND20V-681KB00AAA0	TNR20V681K	420	560		273			1120	830	680 (612~ 748)	7.8	3.1	10.5
TND20V-751KB00AAA0	TNR20V751K	460	615	300	1240	750	750 (675~ 825)	8.2	3.4	10.6			
TND20V-821KB00AAA0	TNR20V821K	510	670	325	1355	700	820 (738~ 902)	8.5	3.6	10.6			
TND20V-911KB00AAA0	TNR20V911K	550	745	360	1500	620	910 (819~1001)	9.0	4.0	10.8			
TND20V-102KB00AAA0	TNR20V102K	625	825	6500A/2 times	400	1.0	100	1650	560	1000 (900~1100)	9.5	4.3	10.9
TND20V-112KB00AAA0	TNR20V112K	680	895		440			1815	510	1100 (990~1210)	10.1	4.7	11.0
TND20V-122KB00AAA0	TNR20V122K	720	980		480			1950	450	1200 (1080~1320)	10.8	5.1*	11.2**
TND20V-152KB00AAA0	TNR20V152K	860	1220	600	2440	390	1500 (1350~1650)	12.8	6.2*	11.8**			
TND20V-182KB00AAA0	TNR20V182K	1000	1465	720	2970	340	1800 (1700~1980)	14.8	7.4*	12.4**			

*E±2 **W2±2

◆ DIMENSIONS [mm]

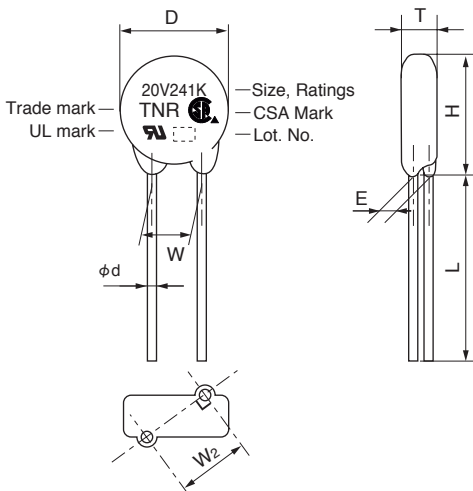

Part Number	D Max.	H Max.	T Max.	L Min.	φd ±0.05	W ±1.0
TND20V-180K to TND20V-511K	21.5	24.5	Ref. to Ratings	20	0.8	10.0
TND20V-561K to TND20V-112K	22.5	25.5				
TND20V-122K to TND20V-182K	23.5	28.0				

V Series

◆V-I CURVE (Type 20V)

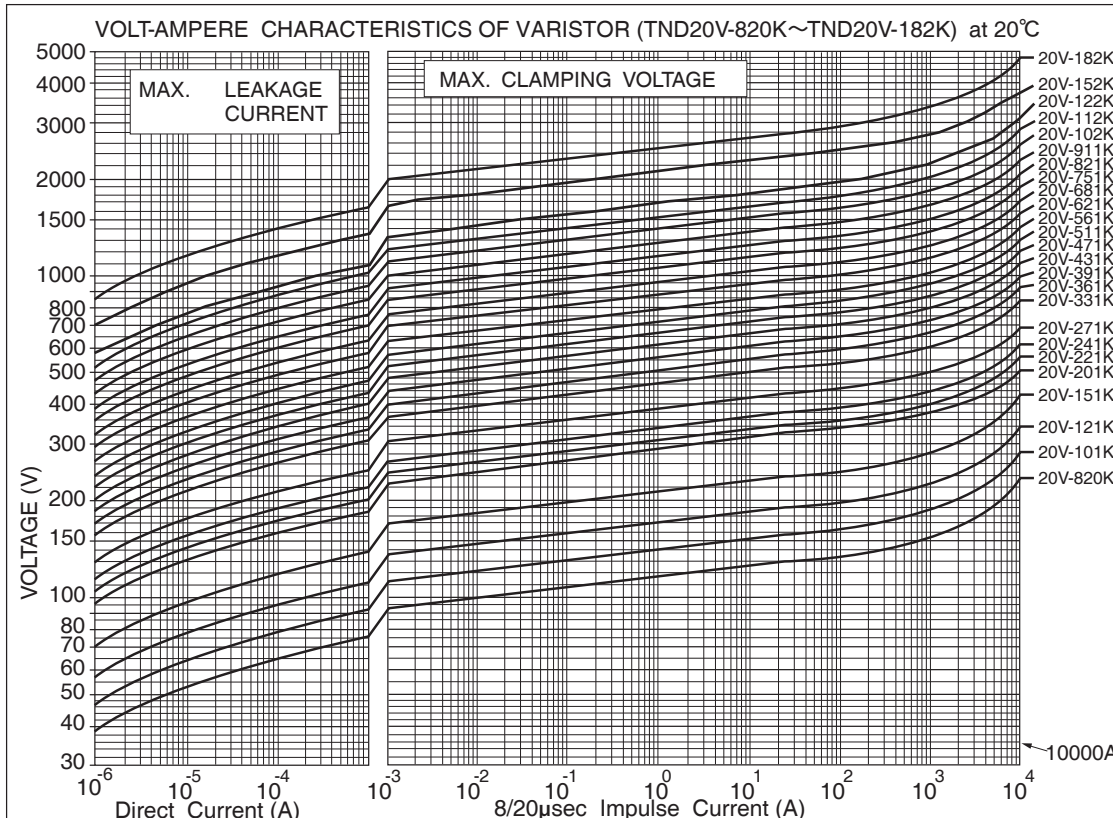
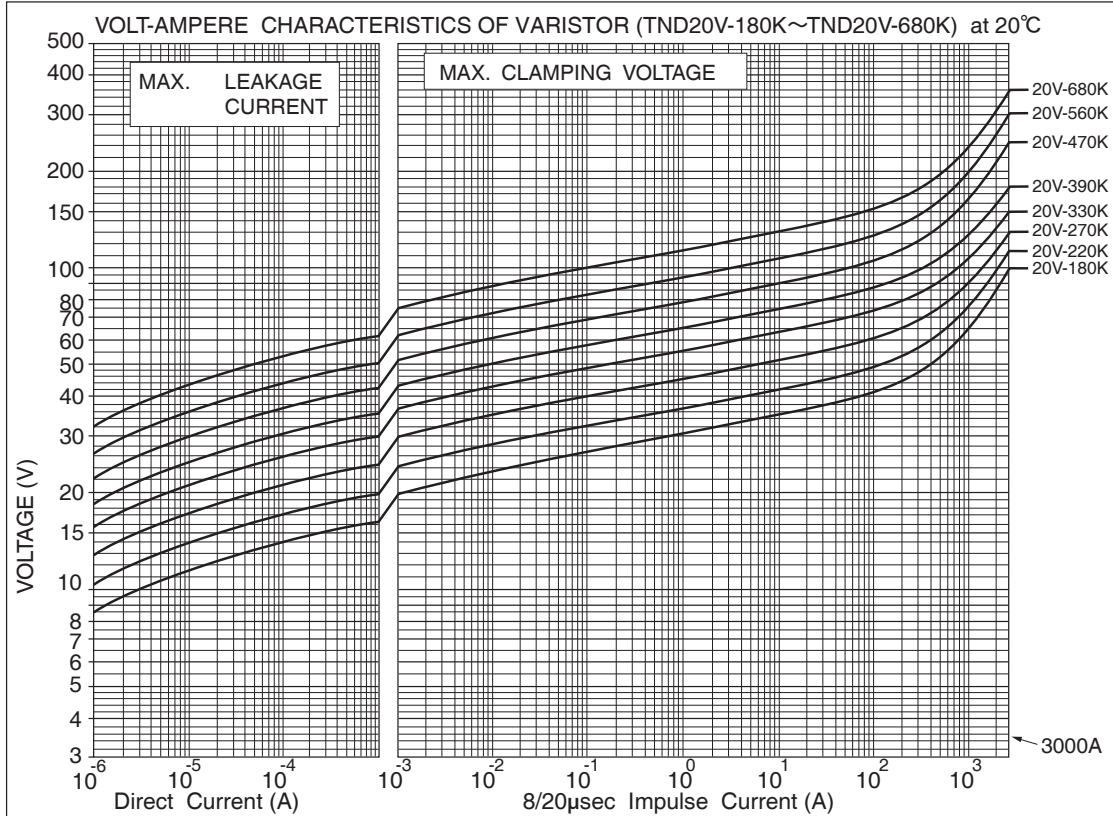



V Series

◆GENERAL SPECIFICATIONS

Item	Test Conditions	Specifications						
Standard Test Condition	20±15°C, 85%RH Max.							
Varistor Voltage	Voltage across varistor at specified current.	Satisfy the specification						
	<table border="1"> <thead> <tr> <th>Type</th> <th>Current CmA</th> </tr> </thead> <tbody> <tr> <td>5V</td> <td>0.1</td> </tr> <tr> <td>7V, 9V, 10V, 12V, 14V, 20V</td> <td>1.0</td> </tr> </tbody> </table>		Type	Current CmA	5V	0.1	7V, 9V, 10V, 12V, 14V, 20V	1.0
	Type		Current CmA					
5V	0.1							
7V, 9V, 10V, 12V, 14V, 20V	1.0							
Maximum Allowable Voltage	Maximum continuous AC voltage (50 to 60Hz AC) and maximum DC voltage which can be applied.	Satisfy the specification						
Maximum Peak Surge Current	Maximum surge current (8/20µs pulse wave to be applied once, or twice, 5 minutes apart) for varistor voltage change within ±10% of the initial value.	Satisfy the specification						
Energy Rating	Maximum energy (2 ms. square wave to be applied once) for varistor voltage change within ±10% of the initial value.	Satisfy the specification						
Rated Wattage	Maximum power (50 to 60Hz AC power to be applied for 1000 hours at 85±2°C) for varistor voltage change within ±10% of the initial value.	Satisfy the specification						
Maximum Clamping Voltage	Maximum voltage across varistor when 8/20µs rated current surge is applied.	Satisfy the specification						
Capacitance	Varistor's capacitance at 1kHz, standard test condition.	For reference only.						
Voltage Temperature Coefficient	$\frac{V_{CmA} \text{ at } 85^{\circ}\text{C} - V_{CmA} \text{ at } 25^{\circ}\text{C}}{V_{CmA} \text{ at } 25^{\circ}\text{C}} \times \frac{1}{60} \times 100 (\% / ^{\circ}\text{C})$ <p style="text-align: right;">V CmA : Actual varistor voltage</p>	Within ±0.05%/°C						
Insulation	Short circuit the two leads of varistor, and put the varistor body into metal balls (1.6mm diameter) leaving 2mm epoxy coating outside. Then, apply 2.5kVrms between the leads and the metal balls for 60±5 sec..	The varistor shall withstand with no abnormality.						

◆ENVIRONMENTAL CHARACTERISTICS

Item	Test Conditions	Specifications
High Temperature Storage (Dry heat)	The specimen shall be subjected 125±2°C for 1000±12 hours without load.	$\Delta V_{CmA} / V_{CmA} \leq \pm 5\%$ However, on varistors have nominal varistor voltages from 15V to 68V, the varistor voltage change shall be $\Delta V_{CmA} / V_{CmA} \leq \pm 10\%$
Low Temperature Storage	The specimen shall be subjected -40±2°C for 1000±12 hours without load.	$\Delta V_{CmA} / V_{CmA} \leq \pm 5\%$
Damp heat (Humidity)	The specimen shall be subjected to 40±2°C, 90 to 95%RH for 1000±12 hours without load.	$\Delta V_{CmA} / V_{CmA} \leq \pm 5\%$
Temperature Cycle	The temperature cycle shown below shall be repeated 5 cycles. -40±3°C, 30 minutes ⇔ +85±2°C, 30 minutes	$\Delta V_{CmA} / V_{CmA} \leq \pm 5\%$ No remarkable damage
High Temperature Operating	The specimen shall be subjected to 85±2°C with the maximum allowable voltage for 1000±12 hours.	$\Delta V_{CmA} / V_{CmA} \leq \pm 10\%$
Damp heat Operating	The specimen shall be subjected to 40±2°C, 90 to 95%RH with the maximum allowable voltage for 1000±12 hours.	$\Delta V_{CmA} / V_{CmA} \leq \pm 10\%$

Varistor voltage change of forward direction shall be measured in the test of unipolar surge life and DC load life.

Varistor voltage change is measured after stored at Standard Test Conditions for 1 to 2 hours.

Note : For 42V battery line, please contact our sales office.



V Series

◆MECHANICAL CHARACTERISTICS

Item	Test Conditions	Specifications												
Resistance to Soldering Heat	<p>After V CmA is measured at room temperature, each lead shall be dipped into a solder bath at a temperature of 350±10°C to a point 2.0 to 2.5 mm from the root of the lead, and be held there for 3⁺¹₀ seconds, and then be stored at room temperature for 1 to 2 hours. Then, V CmA shall be examined. (Conform to JIS C 5102)</p> <p>or</p> <p>After V CmA is measured at room temperature, each lead shall be dipped into a solder bath at a temperature of 260±10°C to a point 2.0 to 2.5 mm from the root of the lead, be held there for 10±1 seconds, and then be stored at room temperature for 1 to 2 hours. Then, V CmA shall be examined.</p>	<p>$\Delta V \text{ CmA} / V \text{ CmA} \leq \pm 5\%$</p> <p>No remarkable damage</p>												
Solderability	<p>Each lead shall be dipped into an ethanol solution (about 25%) of rosin for 5 to 10 sec. Then each lead shall be dipped into a solder.</p> <table border="1"> <thead> <tr> <th>Solder</th> <th>Pb free (Sn-3.0Ag-0.5Cu)</th> <th>Eutectic (Sn/Pb)</th> </tr> </thead> <tbody> <tr> <td>Solder Temp.</td> <td>245±5°C</td> <td>235±5°C</td> </tr> <tr> <td>Dipping Time</td> <td colspan="2">2±0.5sec.</td> </tr> <tr> <td>Dipping Depth</td> <td colspan="2">1.5 to 2.0mm (from the body)</td> </tr> </tbody> </table>	Solder	Pb free (Sn-3.0Ag-0.5Cu)	Eutectic (Sn/Pb)	Solder Temp.	245±5°C	235±5°C	Dipping Time	2±0.5sec.		Dipping Depth	1.5 to 2.0mm (from the body)		<p>At least, 95% of the leads shall be covered with solder uniformly.</p>
Solder	Pb free (Sn-3.0Ag-0.5Cu)	Eutectic (Sn/Pb)												
Solder Temp.	245±5°C	235±5°C												
Dipping Time	2±0.5sec.													
Dipping Depth	1.5 to 2.0mm (from the body)													
Lead Pull Strength	<p>Fix varistor body, and suspend specified weight toward direction of lead axis.</p> <table border="1"> <thead> <tr> <th>Type</th> <th>Lead Diameter</th> <th>Weight</th> </tr> </thead> <tbody> <tr> <td>5V, 7V, 9V</td> <td>0.6mm</td> <td>10N</td> </tr> <tr> <td>10V, 12V, 14V, 20V</td> <td>0.8mm</td> <td>10N</td> </tr> </tbody> </table>	Type	Lead Diameter	Weight	5V, 7V, 9V	0.6mm	10N	10V, 12V, 14V, 20V	0.8mm	10N	<p>No abnormality such as disconnection.</p> <p>$\Delta V \text{ CmA} / V \text{ CmA} \leq \pm 5\%$</p>			
Type	Lead Diameter	Weight												
5V, 7V, 9V	0.6mm	10N												
10V, 12V, 14V, 20V	0.8mm	10N												
Lead Bend Strength	<p>Fix varistor body vertically. Then suspend specified weight and bent the varistor body by 90°, and return it to the original position. Carry out the operation in the opposite direction and return the body to the original position.</p> <table border="1"> <thead> <tr> <th>Type</th> <th>Lead Diameter</th> <th>Weight</th> </tr> </thead> <tbody> <tr> <td>5V, 7V, 9V</td> <td>0.6mm</td> <td>5N</td> </tr> <tr> <td>10V, 12V, 14V, 20V</td> <td>0.8mm</td> <td>5N</td> </tr> </tbody> </table>	Type	Lead Diameter	Weight	5V, 7V, 9V	0.6mm	5N	10V, 12V, 14V, 20V	0.8mm	5N	<p>The leads shall not disconnect, slacken and peel off.</p>			
Type	Lead Diameter	Weight												
5V, 7V, 9V	0.6mm	5N												
10V, 12V, 14V, 20V	0.8mm	5N												
Vibration	<p>Mount varistor body on vibrator, and conduct the following vibration test.</p> <p>Peak-to-Peak amplitude : 1.5mm</p> <p>Vibration frequency range : 10Hz to 55Hz</p> <p>Sweeping time:</p> <p>Approximately one minute for 10Hz → 55Hz → 10Hz</p> <p>Direction and duration of vibration :</p> <p>Three directions of X, Y and Z. Two hours each.</p> <p>Six hours total.</p>	<p>No remarkable appearance abnormality.</p> <p>$\Delta V \text{ CmA} / V \text{ CmA} \leq \pm 5\%$</p>												

PULSE LIFE TIME RATINGS

When the following factors are different from the specified conditions, the peak pulse current should be revised based on the PULSE LIFE TIME RATINGS.

- Impulse duration time
- Number of impulse

(Impulse Current Wave Form)

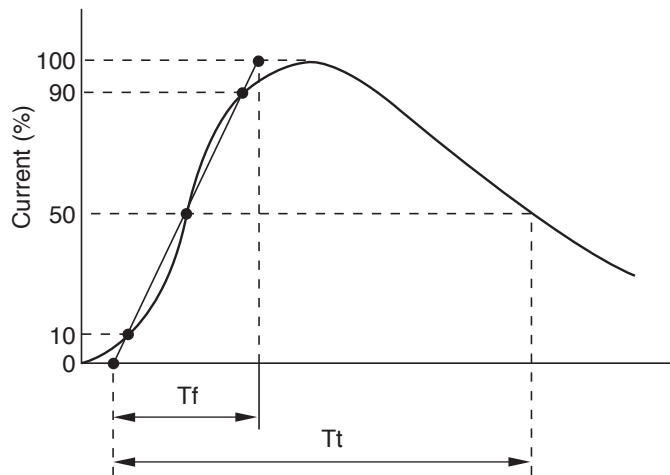

Tf : (Rise Time)

Tt : (Impulse Duration)

● V series

PULSE LIFE TIME RATINGS
(TND05V-180K~680K)

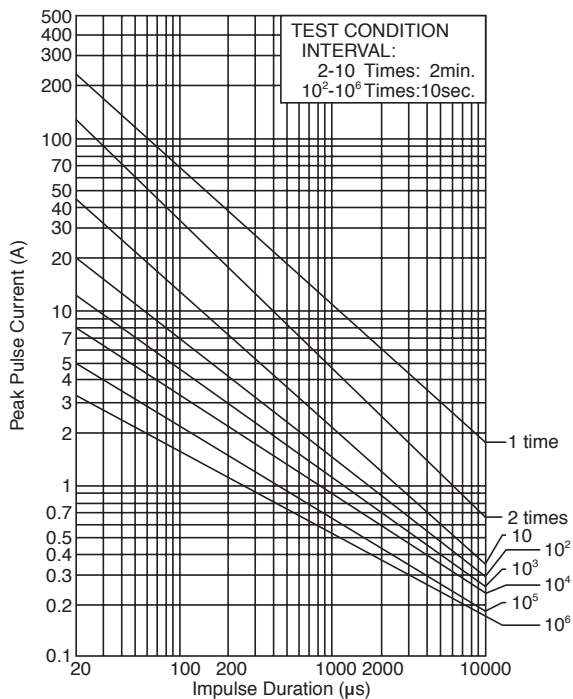

PULSE LIFE TIME RATINGS
(TND05V-820K~471K)

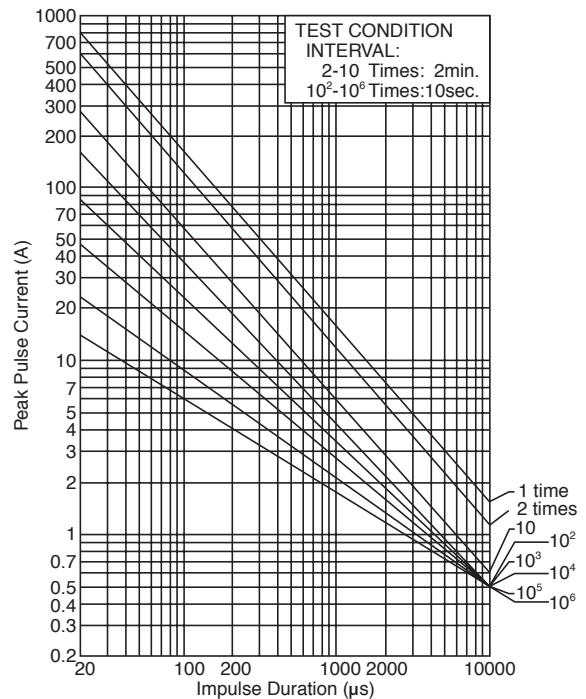

●V series

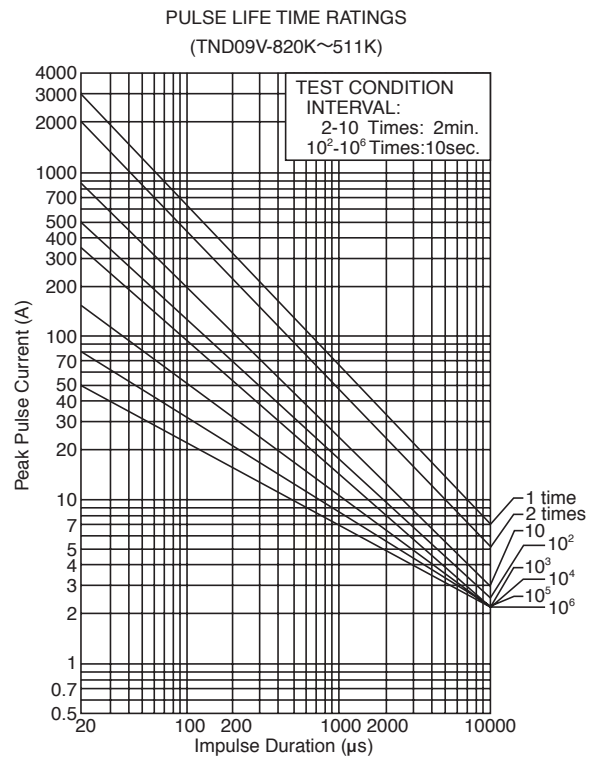
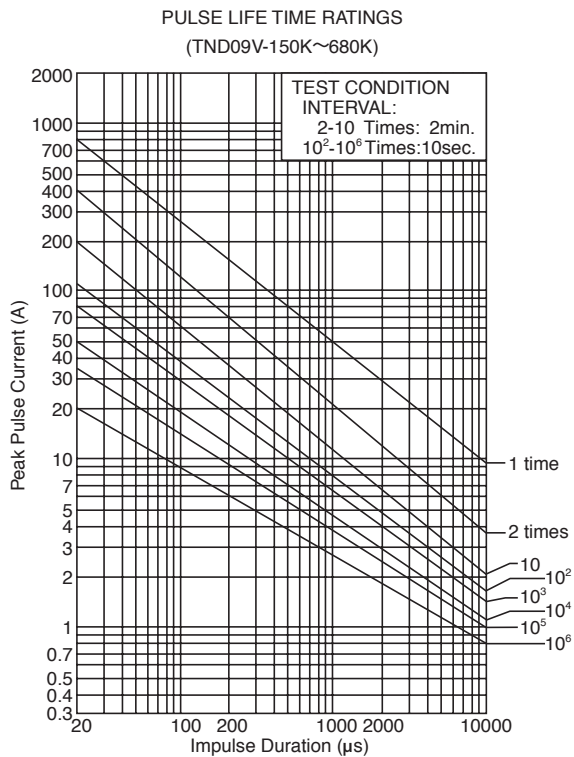
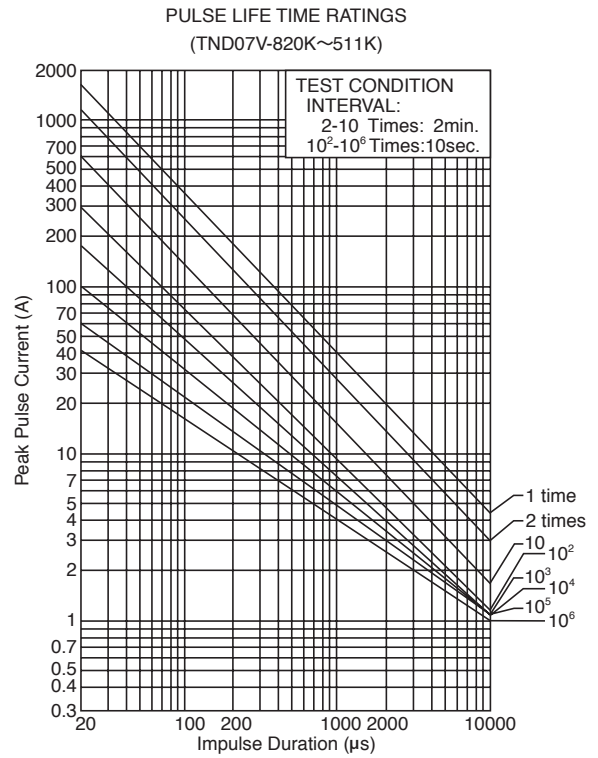
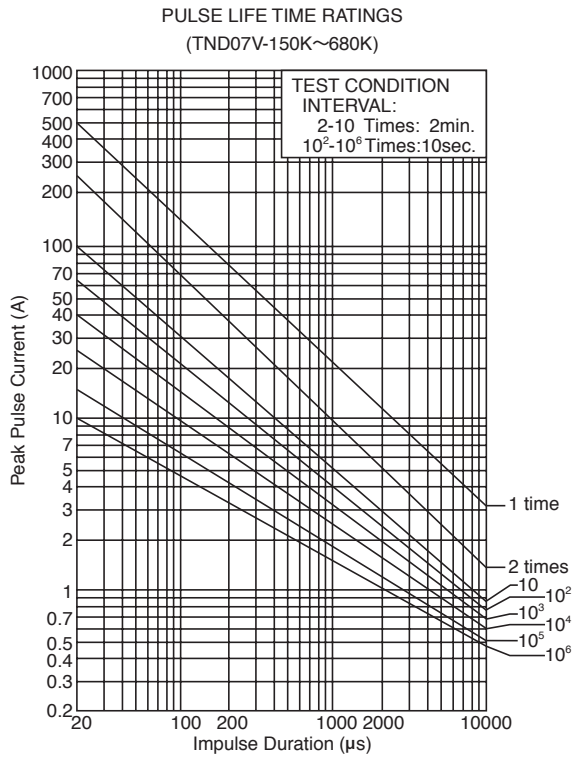

● V series

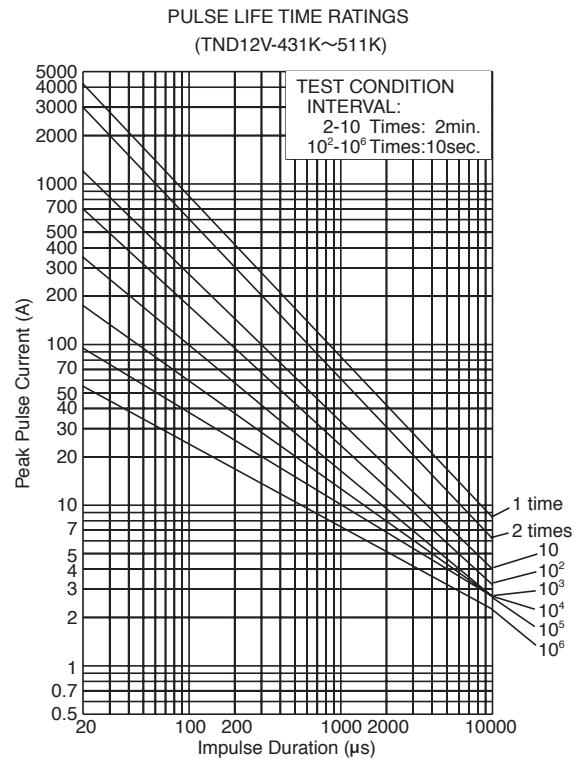
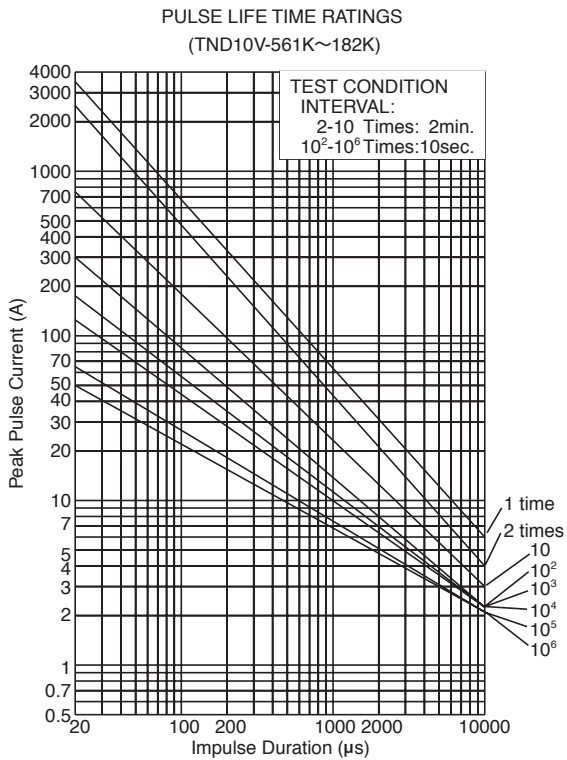
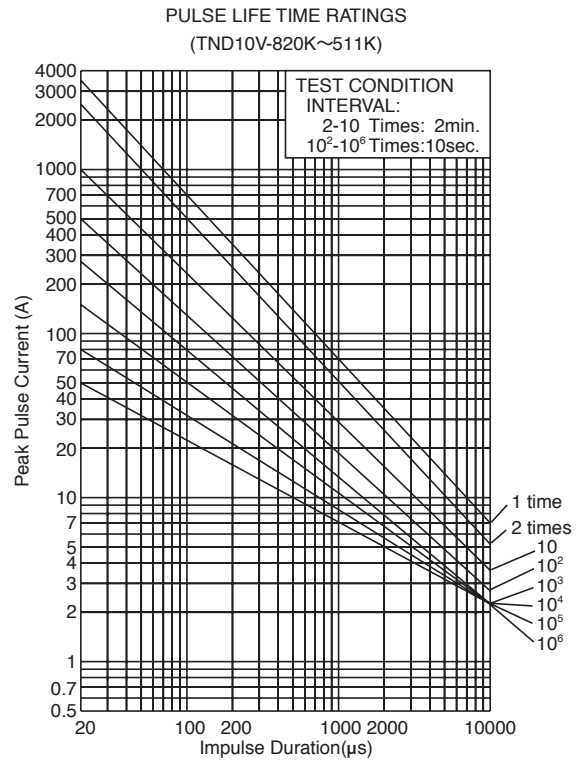
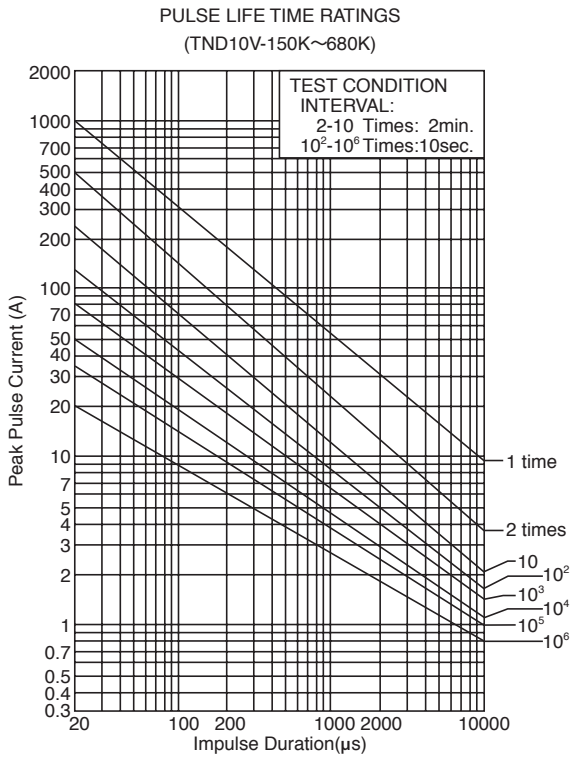

●V series

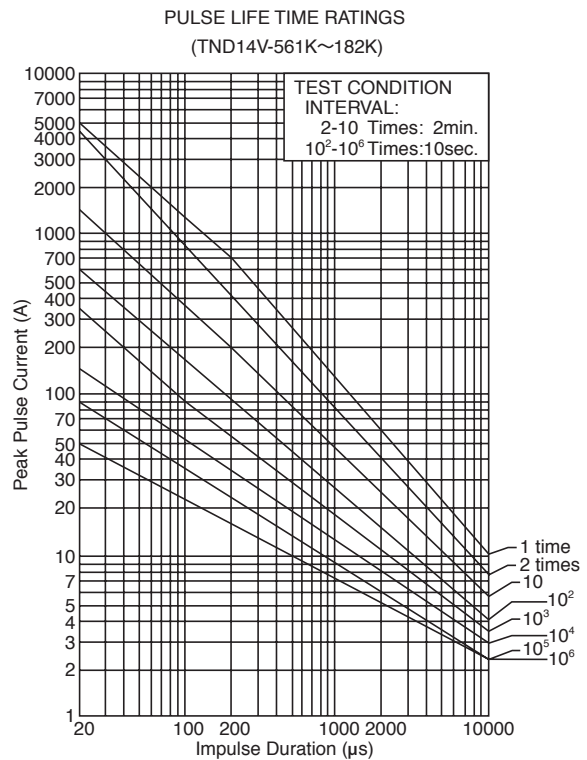
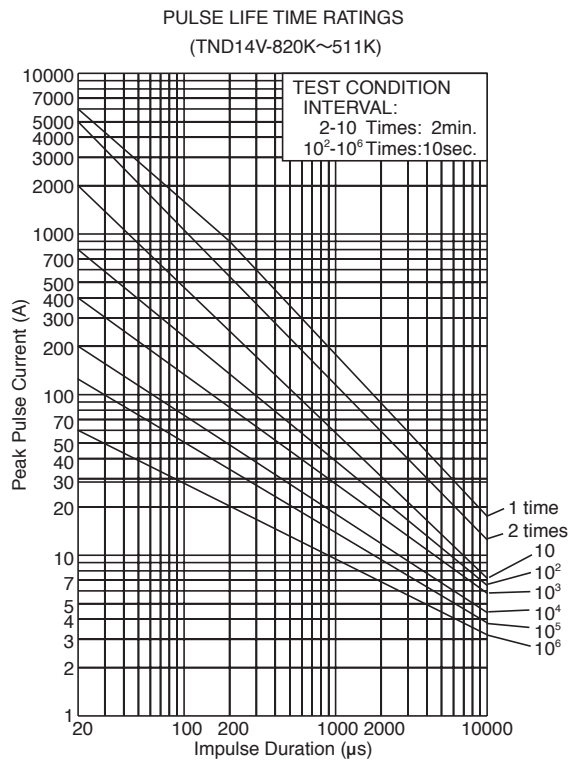
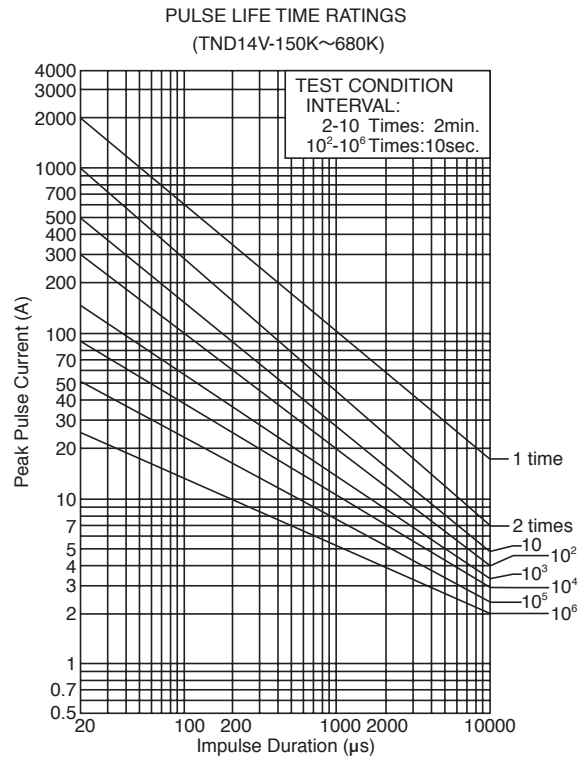
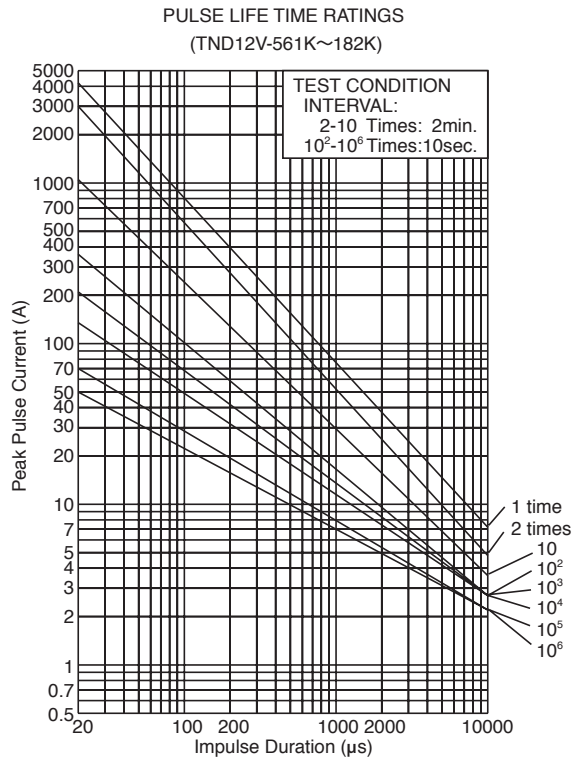

●V series

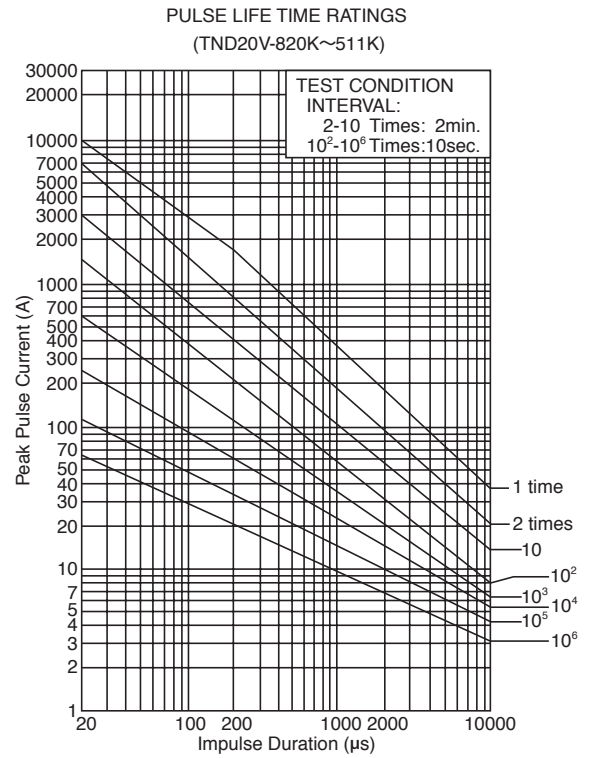
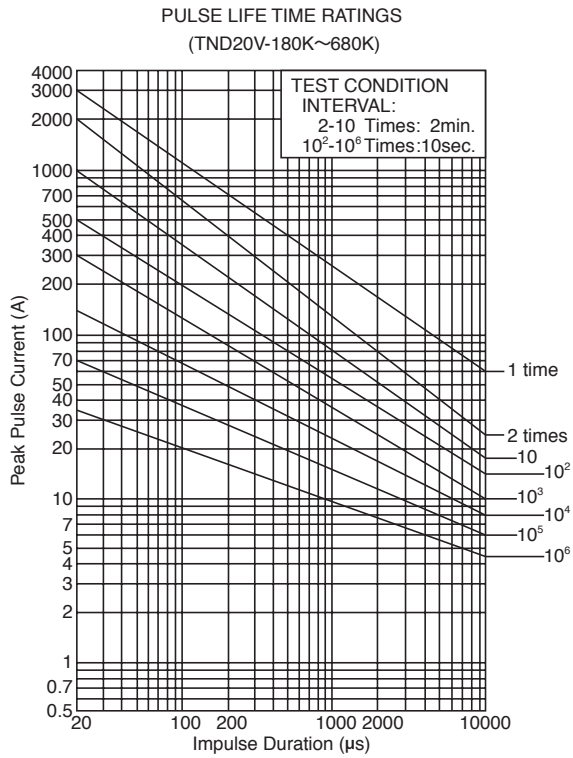

●V series

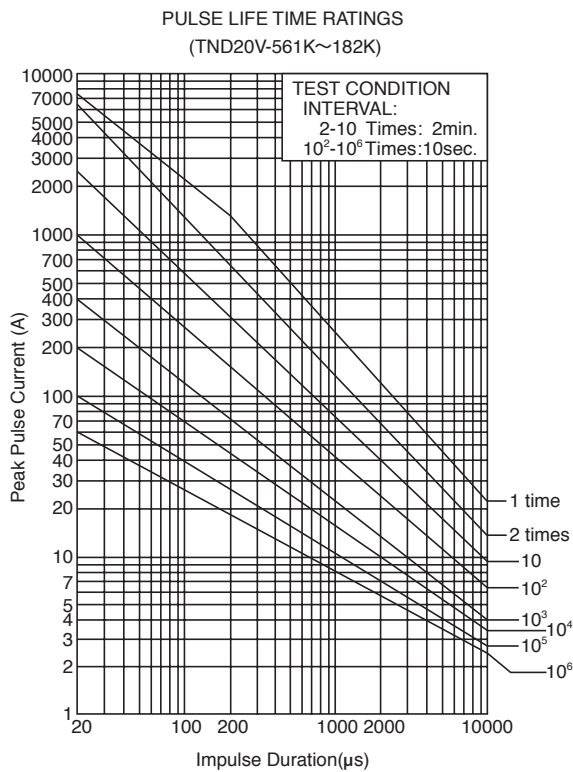



- Always read "Notes on Use" before using the product in order to enable you to use the product correctly and prevent any faults and accidents from occurring.
- Request the Product Specification on the product of NIPPON CHEMI-CON CORPORATION to refer to it as well as this brochure prior to the order of the products. Some specific notes on use of the ordered product may be described in the specifications.
- The products listed in this catalog are designed and manufactured for general electronics equipment use and are not intended for use in applications that can adversely affect human life; where the malfunction of equipment may cause damage to life or property. In addition, our products are not intended to be used in specific applications that may cause a major social impact. Please consult with us in advance of usage of our products in the following listed applications. ① Aerospace equipment ② Power generation equipment such as thermal power, nuclear power etc. ③ Medical equipment ④ Transport equipment (automobiles, trains, ships, etc.) ⑤ Transportation control equipment ⑥ Disaster prevention / crime prevention equipment ⑦ Highly publicized information processing equipment ⑧ Submarine equipment ⑨ Other applications that are not considered general-purpose applications.
- The circuits described as examples in this catalog and the "delivery specifications" are featured in order to show the operations and usage of our products, however, this fact does not guarantee that the circuits are available to function in your equipment systems. We are not in any case responsible for any failures or damage caused by the use of information contained herein. You should examine our products, of which the characteristics are described in the "delivery specifications" and other documents, and determine whether or not our products suit your requirements according to the specifications of your equipment systems. Therefore, you bear final responsibility regarding the use of our products.
Please make sure that you take appropriate safety measures such as use of redundant design and malfunction prevention measures in order to prevent fatal accidents and/or fires in the event any of our products malfunction.
- We strongly recommend our customers to purchase Nippon Chemi-Con products only through our official sales channels. We assume no responsibility for any defects or damages caused by using products purchased from outside our official sales channel or of counterfeit goods. In addition, we will ask the customer to pay the investigation cost for products purchased outside our official sales channel.
- We reserve the right to discontinue production and delivery of products. We do not guarantee that all the products included in this catalog will be available in the future.
The aforementioned does not apply in the case of individual agreements deviating from the foregoing for customer-specific products
- We continually strive to improve the quality and reliability of our products, but in any case that our product does not meet our published specifications, please stop using it promptly and contact us immediately. As for compensation for non-conforming goods delivered by Chemi-Con, we will limit it only to goods found in non-compliance of our published specifications. This may be accomplished by a no cost replacement of non-conforming individual products, a credit of the piece price paid per each individual non-conforming product, or in other ways deemed necessary.
In addition, we have an established system with enhanced traceability, therefore we will limit the applicable lot items for any potential compensation.

[Lead Forming Specifications](#)

[Precautions and Guidelines](#)

[Taping](#)

[Technical Terms on Varistors](#)

[Packaging • Minimum Order Quantity](#)

[Safety Standard](#)

[Technical Notes](#)