

Signal Relays (2 A or less)

GQ RELAYS TH Types

Product Catalog

**IN Your
Future**

GQ RELAYS TH types

Small size controlled 3.5 A inrush current possible

Protective construction : Sealed type

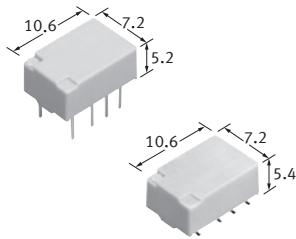

(Unit : mm)

FEATURES

- Small size controlled 3.5 A inrush current possible
- 2.4 coil voltage type newly available DC battery operation
- Flat compact size
10.6 (L) × 7.2 (W) × 5.2 (H) mm

TYPICAL APPLICATIONS

- Thermostat (HVAC temperature controller)
- Others, High-capacity control etc.

ORDERING INFORMATION (PART NO.)

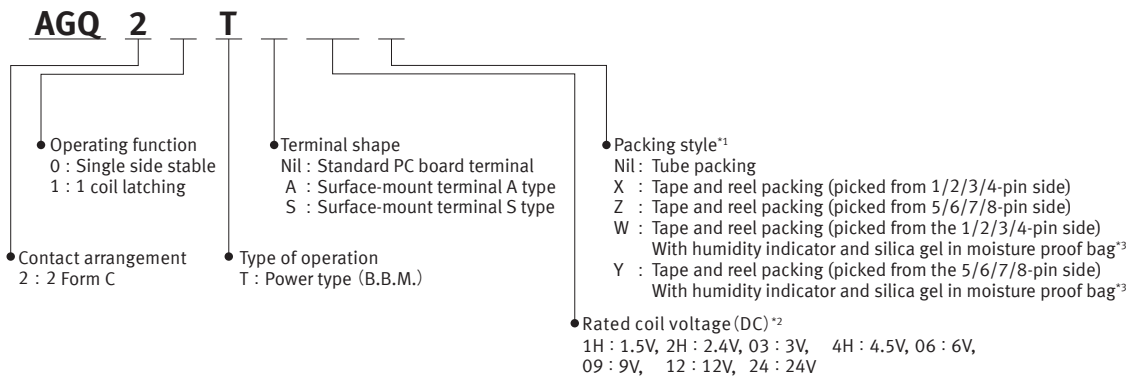

*1. The "W" and "Y" at the end of the part number only appears on the inner and outer packing. It does not appear on the relay itself.

*2. Please inquire if you require a relay, between 1.5 and 24 V DC, with a voltage not listed.

*3. Each reel is packed with humidity indicators and silica gel in the moisture proof pack.

Signal Relays (2 A or less) GQ RELAYS TH types

TYPES

■ PC board terminal

● Tube packing

Contact arrangement	Rated coil voltage	Part No.		Standard packing	
		Single side stable	1 coil latching	Carton (1 Tube packing)	Outer carton
2 Form C	1.5 V DC	AGQ20T1H	AGQ21T1H	50 pcs.	1,000 pcs.
	2.4 V DC	AGQ20T2H	AGQ21T2H		
	3 V DC	AGQ20T03	AGQ21T03		
	4.5 V DC	AGQ20T4H	AGQ21T4H		
	6 V DC	AGQ20T06	AGQ21T06		
	9 V DC	AGQ20T09	AGQ21T09		
	12 V DC	AGQ20T12	AGQ21T12		
	24 V DC	AGQ20T24	AGQ21T24		

■ Surface-mount terminal

● Tube packing

Contact arrangement	Rated coil voltage	Part No.		Standard packing	
		Single side stable	1 coil latching	Carton (1 Tube packing)	Outer carton
2 Form C	1.5 V DC	AGQ20T*1H	AGQ21T*1H	50 pcs.	1,000 pcs.
	2.4 V DC	AGQ20T*2H	AGQ21T*2H		
	3 V DC	AGQ20T*03	AGQ21T*03		
	4.5 V DC	AGQ20T*4H	AGQ21T*4H		
	6 V DC	AGQ20T*06	AGQ21T*06		
	9 V DC	AGQ20T*09	AGQ21T*09		
	12 V DC	AGQ20T*12	AGQ21T*12		
	24 V DC	AGQ20T*24	AGQ21T*24		

Note) " * " : For each surface-mount terminal identification, input the following letter. A type: A, S type: S.

● Tape and reel packing: Z

Contact arrangement	Rated coil voltage	Part No.		Standard packing	
		Single side stable	1 coil latching	Carton (1 Reel packing)	Outer carton
2 Form C	1.5 V DC	AGQ20T*1HZ	AGQ21T*1HZ	900 pcs.	1,800 pcs.
	2.4 V DC	AGQ20T*2HZ	AGQ21T*2HZ		
	3 V DC	AGQ20T*03Z	AGQ21T*03Z		
	4.5 V DC	AGQ20T*4HZ	AGQ21T*4HZ		
	6 V DC	AGQ20T*06Z	AGQ21T*06Z		
	9 V DC	AGQ20T*09Z	AGQ21T*09Z		
	12 V DC	AGQ20T*12Z	AGQ21T*12Z		
	24 V DC	AGQ20T*24Z	AGQ21T*24Z		

Notes) 1: " * " : For each surface-mount terminal identification, input the following letter. A type: A, S type: S.
 2: For taping packaging X, W, and Y, change " Z " at the end of the part number to " X ", " W ", and " Y ".
 3: Please inquire if you require a relay, between 1.5 and 24 V DC, with a voltage not listed.

Signal Relays (2 A or less) GQ RELAYS TH types

RATING

Coil data

- Operating characteristics such as " Operate voltage " and " Release voltage " are influenced by mounting conditions or ambient temperature, etc.
Therefore, please use the relay within $\pm 5\%$ of rated coil voltage.
- " Initial " means the condition of products at the time of delivery.

Single side stable

Rated coil voltage	Operate voltage (at 20 °C)	Release voltage (at 20 °C)	Rated operating current ($\pm 10\%$, at 20 °C)	Coil resistance ($\pm 10\%$, at 20 °C)	Rated operating power	Max. allowable voltage (at 20 °C)
1.5 V DC	Max. 75 % V of rated coil voltage* (Initial)	Min. 10 % V of rated coil voltage* (Initial)	93.8 mA	16 Ω	140 mW	150 % V of rated coil voltage
2.4 V DC			58.5 mA	41 Ω		
3 V DC			46.7 mA	64.2 Ω		
4.5 V DC			31 mA	145 Ω		
6 V DC			23.3 mA	257 Ω		
9 V DC			15.5 mA	579 Ω		
12 V DC			11.7 mA	1,028 Ω		
24 V DC			9.6 mA	2,504 Ω	230 mW	120 % V of rated coil voltage

1 coil latching

Rated coil voltage	Set voltage (at 20 °C)	Reset voltage (at 20 °C)	Rated operating current ($\pm 10\%$, at 20 °C)	Coil resistance ($\pm 10\%$, at 20 °C)	Rated operating power	Max. allowable voltage (at 20 °C)
1.5 V DC	Max. 75 % V of rated coil voltage* (Initial)	Max. 75 % V of rated coil voltage* (Initial)	66.7 mA	22.5 Ω	100 mW	150 % V of rated coil voltage
2.4 V DC			41.7 mA	57.6 Ω		
3 V DC			33.3 mA	90 Ω		
4.5 V DC			22.2 mA	202.5 Ω		
6 V DC			16.7 mA	360 Ω		
9 V DC			11.1 mA	810 Ω		
12 V DC			8.3 mA	1,440 Ω		
24 V DC			5.0 mA	4,800 Ω	120 mW	

* Pulse drive (JIS C 5442-1996)

Signal Relays (2 A or less) GQ RELAYS TH types

Specifications

Item	Specifications	
Contact data	Contact arrangement	2 Form C
	Contact resistance (Initial)	Max. 100 mΩ (by voltage drop 6 V DC 1 A)
	Contact material	AgNi + Au plating
	Contact rating (resistive)	2 A 30 V DC, 1 A 30 V DC, 0.3 A 125 V AC
	Max. switching power (resistive)	60 W (DC), 30 W (DC), 37.5 V A (AC)
	Max. switching voltage	110 V DC, 125 V AC
	Max. switching current	2 A (AC, DC)
	Min. switching load (Reference value) ^{*1}	10 μA 10 mV DC
Rated operating power	Single side stable	140 mW (1.5 to 12 V DC), 230 mW (24 V DC)
	1 coil latching	100 mW (1.5 to 12 V DC), 120 mW (24 V DC)
Insulation resistance (Initial)		Min. 1,000 MΩ (at 500 V DC) Measured portion is the same as the case of dielectric voltage
Dielectric strength (initial)	Between open contacts	750 Vrms for 1 min (detection current: 10 mA)
	Between contact and coil	1,500 Vrms for 1 min (detection current: 10 mA)
	Between contact sets	1,000 Vrms for 1 min (detection current: 10 mA)
Surge withstand voltage (Initial)	Between open contacts	1,500 V (10 × 160 μs) (FCC Part 68)
	Between contact and coil	2,500 V (2 × 10 μs) (Telcordia)
Temperature rise (at 20 °C)		Max. 50 °C (By resistive method, rated coil voltage applied to the coil; contact carrying current: 2 A)
Time characteristics (initial)	Operate time (Set time) (at 20 °C)	Max. 4 ms (Max. 4 ms) (Rated coil voltage applied to the coil, excluding contact bounce time.)
	Release time (Reset time) (at 20 °C)	Max. 4 ms (Max. 4 ms) (Rated coil voltage applied to the coil, excluding contact bounce time.) (without diode)
Shock resistance	Functional	750 m/s ² (half -sine shock pulse: 6 ms; detection time: 10 μs)
	Destructive	1,000 m/s ² (half -sine shock pulse: 6 ms.)
Vibration resistance	Functional	10 to 55 Hz at double amplitude of 3.3 mm (detection time: 10 μs)
	Destructive	10 to 55 Hz at double amplitude of 5.0 mm
Expected life	Mechanical	Min. 50 × 10 ⁶ ope. (at 180 cpm)
	Electrical	Min. 100 × 10 ³ ope. (1 A 30 V DC resistive) Min. 100 × 10 ³ ope. (3.5 A inrush (250 ms) / 1 A 30 V AC (cos φ=0.4)) (ON/OFF=1 s/9 s)
Conditions	Conditions for operation, transport and storage ^{*2}	Ambient temperature: (Single side stable, 1 coil latching type) -40 to +85 °C Humidity: 5 to 85% RH (Avoid icing and condensation)
Unit weight		Approx. 1.0 g

*1: This value can change due to the switching frequency, environmental conditions, and desired reliability level, therefore it is recommended to check this with the actual load.

*2: Refer to " AMBIENT ENVIRONMENT " in GENERAL APPLICATION GUIDELINES.

REFERENCE DATA

1. Electrical life (100 × 10³ operation is possible)

Tested sample : AGQ21TA03, 6 pcs.
Switching frequency : ON:OFF = 1s:9s
Ambient temperature : 25 °C

Condition : 30 V AC
Inrush current : 3.5 A (effective value), inrush time 250 ms
steady current : 1.0 A (effective value),
(Inductive load cos φ = 0.4)

Circuit :

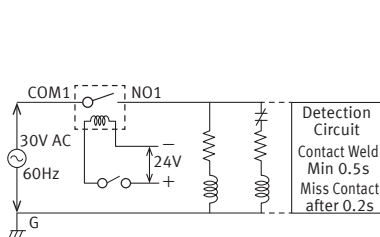

Inrush current wave form vs time

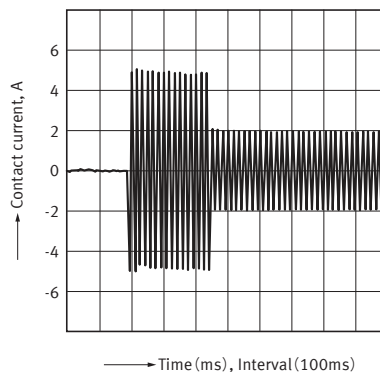

Signal Relays (2 A or less) GQ RELAYS TH types

DIMENSIONS (Unit: mm)

CAD The CAD data of the products with a "CAD" mark can be downloaded from our Website.

PC board terminal

CAD

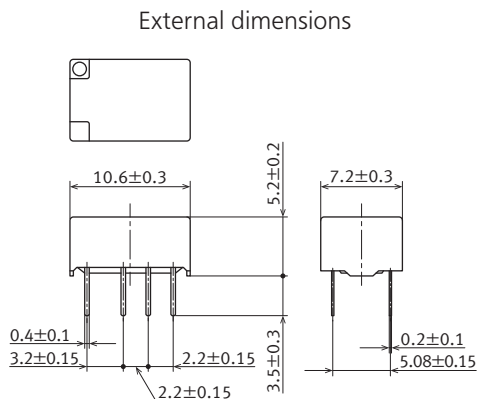
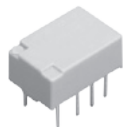

Recommended PC board pattern
(BOTTOM VIEW)

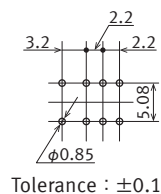

Schematic
(BOTTOM VIEW)
Single side stable
(De-energize)

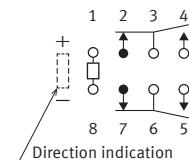

1 coil latching
(Reset)

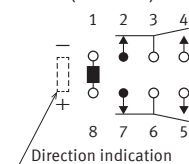

Surface-mount terminal

CAD



Type	External dimensions	Recommended PC board pattern (TOP VIEW)
A		<p>Tolerance : ±0.1</p>
S		<p>Tolerance : ±0.1</p>

Schematic
(TOP VIEW)
Single side stable
(De-energize)

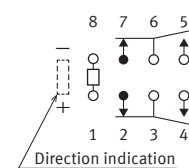

1 coil latching
(Reset)

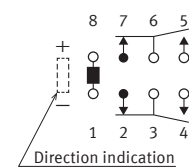

Signal Relays (2 A or less) GQ RELAYS TH types

PACKING STYLE (Unit: mm)

■ Tube packing

- 1) The relay is packing in a tube with the relay orientation mark on the left side, as shown in the figure below. Be sure to maintain relays in the correct orientation when mounting on PC boards.
- 2) Conditions for operation, transport and storage: -40 to 70 °C.

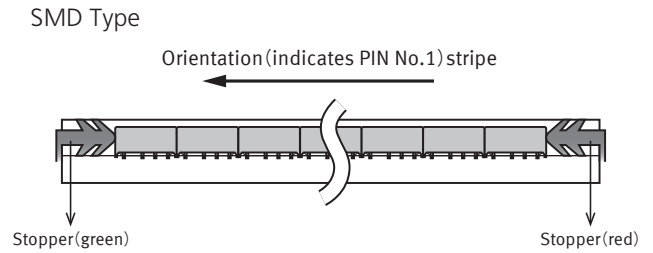
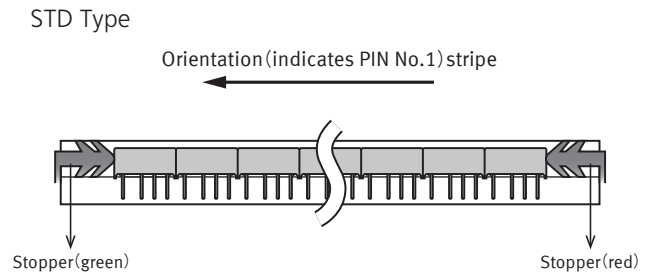

■ Taping packaging

- 1) Tape dimensions

A Type

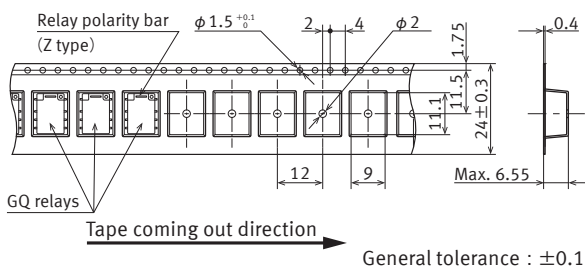

S Type

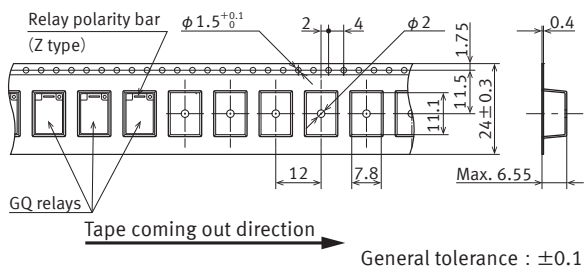

- 2) Dimensions of plastic reel

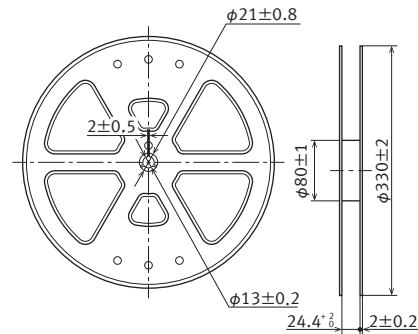

- 3) Conditions for operation, transport and storage: -40 to 70 °C.

Signal Relays (2 A or less) GQ RELAYS TH types

EXAMPLE OF RECOMMENDED SOLDERING CONDITIONS

■ For cautions for use, please read " Relay Soldering and Cleaning Guidelines " and " SMT Soldering Guidelines ".

■ PC board terminal

In case of hand soldering, the following conditions should be observed.

The effect on the relay depends on the PC board used. Please verify the actual PC board to be used.

● Automatic soldering (Flow)

Recommended conditions	Temperature	Time	Measurement location
Preheating	Max. 120 °C	Within 120 seconds	Solder surface terminal
Soldering	260 °C ±5 °C	Within 6 seconds	Solder temperature

● Hand soldering

Recommended conditions	Temperature	Time	Measurement location
Soldering	Max. 350 °C	Within 3 seconds	Tip temperature

■ Surface-mount terminal

In case of automatic soldering (reflow), the following conditions should be observed.

● IRS (infrared reflow soldering method) heating conditions

Recommend conditions	
Number of reflow	1 time
Measuring position	Surface of PC board where relay is mounted.

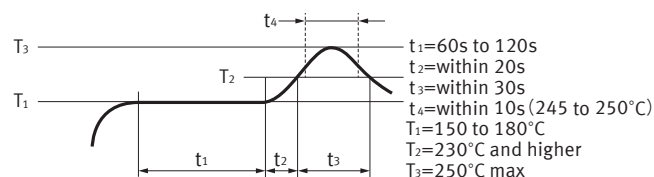

Measuring position of temperature profile

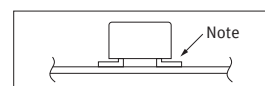

Note : The soldering temperature profile indicates the pad temperature. In some cases, the ambient temperature may be greatly increased. Check for the specific mounting condition.

● Mounting cautions

Cautions to observe when mounting temperature increases in the relay are greatly dependent on the way different parts are located a PC board and the heating method of the reflow device. Therefore, please conduct testing on the actual device beforehand after making sure the parts soldered on the relay terminals and the top of the relay case are within the temperature conditions.

■ Other things to observe

- Exceeding the stipulated conditions when soldering may affect coaxial switch performance. Be sure to consult us beforehand.
- Since thermal stress on a relay will depend on the PC board and process conditions, please be sure to test using the actual PC board.
- Creep-up, wettability and solder strength will differ depending on changes in the mounting conditions and type of solder. Please evaluate based on actual production conditions.
- Only apply coating after the relay has returned to room temperature.

SAFETY STANDARDS

Each standard may be updated at any time, so please check our Website for the latest information.

■ UL/C-UL (Approved)

File No.	Contact rating	Operations	Ambient temperature
E43149	2 A 30 V DC Resistive	50 × 10 ³	40 °C
	1 A 30 V DC Resistive	100 × 10 ³	40 °C
	0.5 A 60 V DC Resistive*	6 × 10 ³	85 °C
	0.3 A 110 V DC Resistive	30 × 10 ³	40 °C
	0.3 A 125 V AC Resistive	100 × 10 ³	40 °C

* Single side stable type 1.5 to 12 V DC only

■ CSA (Approved)

CSA standard approved by C-UL.

■ BSI (Approved)

BSI standard approved by File No. CNF667389

(basic insulation).

Signal Relays (2 A or less) GQ RELAYS TH types

GUIDELINES FOR USAGE

■ For cautions for use, please read " GUIDELINES FOR SIGNAL RELAYS USAGE " and " GUIDELINES FOR RELAY USAGE ".

■ Cautions for usage of GQ relay TH type

● Latching

- Use latching when conditions involve continuous carrying current.
- Regarding the set and reset pulse time, for the purpose of reliable operation under ambient temperature fluctuations and different operating conditions, we recommend setting the coil applied set and reset pulse time to 10 ms or more at the rated coil voltage.
- The relay is shipped in the reset position. But jolts during transport or impacts during installation can change the reset position. It is, therefore, advisable to build a circuit in which the relay can be initialized (set and reset) just after turning on the power.

● Precaution

When using at 3.5 A, connection of NO (pin #5 and #8) and COM (pin #4 and #9) in the circuit is required.

Pin layout and schematic (BOTTOM VIEW) 1 coil latching

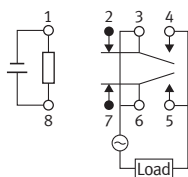

● Precautions for usage of automatic insertion machine

Set the chucking pressure of the pick-up mechanism by the automatic mounting machine with the pressure shown in table 1 to maintain the internal function of the relay.

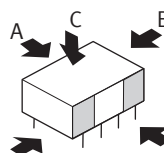

Please chuck the  portion. Avoid chucking the center of the relay. In addition, excessive chucking pressure to the pinpoint of the relay should be also avoided.

Table 1: Chucking pressure

A to C direction	Max. 9.8 N (1 kgf)
------------------	----------------------

GUIDELINES FOR SIGNAL RELAYS USAGE

- For cautions for use, please read " GUIDELINES FOR RELAY USAGE ".
https://industry.panasonic.com/global/en/products/control/relay/cautions_use

PRECAUTIONS FOR COIL INPUT

■ Long term current carrying

A circuit that will be carrying a current continuously for long periods without relay switching operation. (circuits for emergency lamps, alarm devices and error inspection that, for example, revert only during malfunction and output warnings with form B contacts)

Continuous, long-term current to the coil will facilitate deterioration of coil insulation and characteristics due to heating of the coil itself. For circuits such as these, please use a magnetic-hold type latching relay. If you need to use a single stable relay, use a sealed type relay that is not easily affected by ambient conditions and make a failsafe circuit design that considers the possibility of contact failure or disconnection.

■ DC Coil operating power

Steady state DC current should be applied to the coil. The wave form should be rectangular. If it includes ripple, the ripple factor should be less than 5 %. However, please check with the actual circuit since the electrical characteristics may vary. The rated coil voltage should be applied to the coil and the set/reset pulse time of latching type relay differs for each relays, please refer to the relay's individual specifications.

■ Coil connection

When connecting coils of polarized relays, please check coil polarity (+, -) at the internal connection diagram (Schematic).

If any wrong connection is made, it may cause unexpected malfunction, like abnormal heat, fire and so on, and circuit do not work.

Avoid impressing voltages to the set coil and reset coil at the same time.

■ Maximum allowable voltage and temperature rise

Proper usage requires that the rated coil voltage be impressed on the coil.

Note, however, that if a voltage greater than or equal to the maximum continuous voltage is impressed on the coil, the coil may burn or its layers short due to the temperature rise. Furthermore, do not exceed the usable ambient temperature range listed in the catalog.

● Operate voltage change due to coil temperature rise (hot start)

In DC relays, after continuous passage of current in the coil, if the current is turned OFF, then immediately turned ON again, due to the temperature rise in the coil, the operate voltage will become somewhat higher. Also, it will be the same as using it in a higher temperature atmosphere.

The resistance/temperature relationship for copper wire is about 0.4 % for 1 °C, and with this ratio the coil resistance increases.

That is, in order to operate of the relay, it is necessary that the voltage be higher than the operate voltage and the operate voltage rises in accordance with the increase in the resistance value.

However, for some polarized relays, this rate of change is considerably smaller.

NOTES

Usage, Storage, and Transport Conditions

During usage, storage, or transportation, avoid locations subject to direct sunlight and maintain normal temperature, humidity, and pressure conditions.

The allowable specifications for environments suitable for usage, storage, and transportation are given below.

1) Temperature:

The allowable temperature range differs for each relay, so refer to the relay's individual specifications.

In addition, when transporting or storing relays while they are tube packaged, there are cases when the temperature may differ from the allowable range.

In this situation, be sure to consult the individual specifications.

2) Humidity: 5 to 85% RH

The humidity range varies with the temperature.

Use within the range indicated in the graph.

(The allowable temperature depends on the relays.)

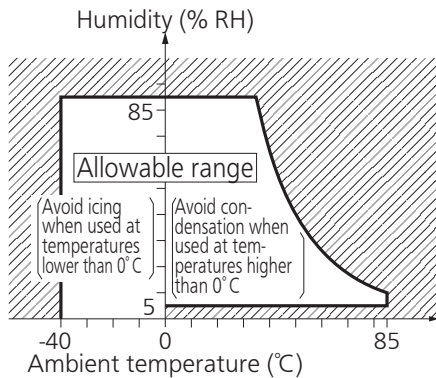

3) Pressure: 86 to 106 kPa

Condensation

Condensation occurs when the ambient temperature drops suddenly from a high temperature and humidity, or the relay and microwave device is suddenly transferred from a low ambient temperature to a high temperature and humidity.

Condensation causes the failures like insulation deterioration, wire disconnection and rust etc.

Panasonic Industry Co., Ltd. does not guarantee the failures caused by condensation.

The heat conduction by the equipment may accelerate the cooling of device itself, and the condensation may occur.

Please conduct product evaluations in the worst condition of the actual usage. (Special attention should be paid when high temperature heating parts are close to the device. Also please consider the condensation may occur inside of the device.)

Icing

Condensation or other moisture may freeze on relays when the temperature become lower than 0 °C.

This icing causes the sticking of movable portion, the operation delay and the contact conduction failure etc.

Panasonic Industry Co., Ltd. does not guarantee the failures caused by the icing.

The heat conduction by the equipment may accelerate the cooling of relay itself and the icing may occur.

Please conduct product evaluations in the worst condition of the actual usage.

Low temperature and low humidity

The plastic becomes brittle if the switch is exposed to a low temperature, low humidity environment for long periods of time.

High temperature and high humidity

Storage for extended periods of time (including transportation periods) at high temperature or high humidity levels or in atmospheres with organic gases or sulfide gases may cause a sulfide film or oxide film to form on the surfaces of the contacts and/or it may interfere with the functions.

Check out the atmosphere in which the units are to be stored and transported.

Package

In terms of the packing format used, make every effort to keep the effects of moisture, organic gases and sulfide gases to the absolute minimum.

GUIDELINES FOR SIGNAL RELAYS USAGE

● Storage requirements

Since the surface-mount terminal type is sensitive to humidity it is packaged with tightly sealed anti-humidity packaging. However, when storing, please be careful of the following.

- 1) Please use promptly once the anti-humidity pack is opened. (within 72 hours, Max. 30 °C / 70% RH). If left with the pack open, the relay will absorb moisture which will cause thermal stress when reflow mounting and thus cause the case to expand. As a result, the seal may break.
- 2) If relays will not be used within 72 hours, please store relays in a humidity controlled desiccator or in an anti-humidity bag to which silica gel has been added.

* If the relay is to be soldered after it has been exposed to excessive humidity atmosphere, cracks and leaks can occur.
Be sure to mount the relay under the required mounting conditions.

- 3) When relays (which is packaged with humidity indicator and silica gel) meeting one of below criteria, please bake (dry) before use.
 - When the storage conditions specified in 1) are exceeded.
 - When humidity indicator is in III or IV status according to judgement standard.

<How to judge>

Please check humidity indicator color and decide if baking is necessary or not.

●: indicate brown, ○: Other than brown (blueish color)

	5%	10%	60%	Bake treatment necessity judgment
I	●	●	●	No need to bake
II	○	●	●	No need to bake
III	○	○	●	Need to bake
IV	○	○	○	Need to bake

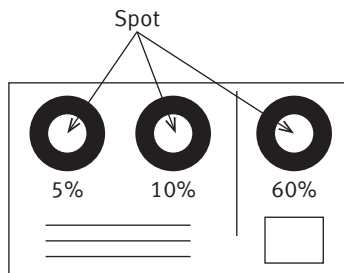

Humidity indicator card

<Baking (Drying) conditions>

- With reel : 45 °C, 96 hours or more.

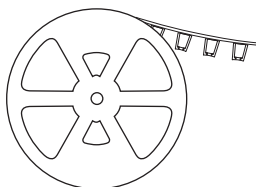

- Without reel (including relay only): 60 °C, 35 hours or more.



- 4) The following cautionary label is affixed to the anti-humidity pack.

C a u t i o n

This vacuum-sealed bag contains

Moisture Sensitive Products

After this bag is opened, the product must be used

within 7 2 h o u r s

If product is not used within 72 hours, baking is necessary.

For baking conditions please contact us.

● Silicon

When a source of silicone substances (silicone rubber, silicone oil, silicone coating materials and silicone filling materials etc.) is used around the relay, the silicone gas (low molecular siloxane etc.) may be produced. This silicone gas may penetrate into the inside of the relay. When the relay is kept and used in this condition, silicone compound may adhere to the relay contacts which may cause the contact failure.
Do not use any sources of silicone gas around the relay (Including plastic seal types).

● NOx Generation

When relay is used in an atmosphere high in humidity to switch a load which easily produces an arc, the NOx created by the arc and the water absorbed from outside the relay combine to produce nitric acid. This corrodes the internal metal parts and adversely affects operation.
Avoid use at an ambient humidity of 85 % RH or higher (at 20 °C).
If use at high humidity is unavoidable, please contact our sales representative.

OTHERS

■ Cleaning

- Although the environmentally sealed type relay (plastic sealed type, etc.) can be cleaned, avoid immersing the relay into cold liquid (such as cleaning solvent) immediately after soldering.
Doing so may deteriorate the sealing performance.
- Surface-mount terminal type relay is sealed type and it can be cleaned by immersion.
Use pure water or alcohol-based cleaning solvent.
- Cleaning with the boiling method is recommended (The temperature of cleaning liquid should be 40°C or lower).
Avoid ultrasonic cleaning on relays.
Use of ultrasonic cleaning may cause breaks in the coil or slight sticking of the contacts due to the ultrasonic energy.

Please refer to " **the latest product specifications** " when designing your product.

- Requests to customers:

<https://industry.panasonic.com/global/en/salespolicies>

■ Global Sales Network Information: industry.panasonic.com/global/en/salesnetwork/globalnetwork

Panasonic
INDUSTRY

Panasonic Industry Co., Ltd.

Electromechanical Control Business Division

■ 1006, Oaza Kadoma, Kadoma-shi, Osaka 571-8506, Japan
industry.panasonic.com