

LUXEON 2835 Color Line

The best performance, the most colors.

The LUXEON 2835 Color Line enables a new era of color lighting. This robust color line provides high performance and is targeted at cost effective designs. Complemented by a broad range of white offerings, the LUXEON 2835 Color Line enables RGBW applications. This product line extends the comprehensive LUXEON Color Family.



FEATURES AND BENEFITS

Single die and single source architecture for optical control

Full color palette for a wider spectrum range

PRIMARY APPLICATIONS

Panel / Soft Lights

Wall Grazer

Linear

Wall Wash

Decorative

Retrofit Lamps

Landscape Lighting

Table of Contents

General Product Information	2
Product Test Conditions	2
Part Number Nomenclature	2
Lumen Maintenance	3
Environmental Compliance	3
Performance Characteristics	4
Product Selection Guide	4
Optical Characteristics	5
Electrical and Thermal Characteristics	6
Absolute Maximum Ratings	7
Characteristic Curves	8
Spectral Power Distribution Characteristics	8
Light Output Characteristics	9
Forward Current Characteristics	16
Radiation Pattern Characteristics	20
Product Bin and Labeling Definitions	22
Decoding Product Bin Labeling	22
Luminous Flux Bins	23
Radiometric Power Bins	24
Color Bin Definitions	25
Peak Wavelength Bins	33
Dominant Wavelength Bins	33
Forward Voltage Bins	34
Mechanical Dimensions	35
Reflow Soldering Guidelines	36
JEDEC Moisture Sensitivity	36
Solder Pad Design	37
Packaging Information	37
Pocket Tape Dimensions	37
Reel Dimensions	38

General Product Information

Product Test Conditions

LUXEON 2835 Color Line LEDs are tested and binned with a 20ms monopulse of DC drive current and junction temperature specified below:

LUXEON 2835 Color at 2V to 3V forward voltage – drive current 120mA, $T_j=25^\circ\text{C}$

LUXEON 2835 Color at 36V forward voltage – drive current 20mA, $T_j=25^\circ\text{C}$

Part Number Nomenclature

Part numbers for LUXEON 2835 Color Line follow the convention below:

L 1 2 8 – **A A A B 0 C** 3 5 0 0 0 0 0

Where:

- A A A** – designates color (FRD=Far Red, DRD=Deep Red, RED=Red, RNG=Red-Orange, PCO=PC Red-Orange, PCA=PC Amber, MNT=Mint, LME=Lime, GRN=Green, PCG=PC Green, CYN=Cyan, BLU=Blue, PCB=PC Blue, RYL=Royal Blue)
- B** – designates product option (example 1, 2...etc)
- C** – designates forward voltage category (example: 0=regular 2V to 3V, L=high voltage at 36V)

Therefore, the following part number is used for a LUXEON 2835 Red LED at 2V to 3V forward voltage category:

L 1 2 8 – **R E D** 1 0 0 3 5 0 0 0 0 0

Part numbers for LUXEON 2835 White follow the convention below:

L 1 2 8 – **A A B B** 0 0 3 5 0 0 0 0 0

Where:

- A A** – designates nominal CCT (30=3000K, 40=4000K, 57=5700K)
- B B** – designates minimum CRI (70=70CRI, 80=80CRI)

Therefore, the following part number is used for a LUXEON 2835 White 3000K 80CRI LED:

L 1 2 8 – **3 0 8 0** 0 0 3 5 0 0 0 0 0

Lumen Maintenance

Please contact your local Sales Representative or Lumileds Technical Solutions Manager for more information about the long-term performance of this product.

Environmental Compliance

Lumileds LLC is committed to providing environmentally friendly products to the solid-state lighting market. LUXEON 2835 Color Line is compliant to the European Union directives on the restriction of hazardous substances in electronic equipment, namely the RoHS Directive 2011/65/EU and REACH Regulation (EC) 1907/2006. Lumileds LLC will not intentionally add the following restricted materials to its products: lead, mercury, cadmium, hexavalent chromium, polybrominated biphenyls (PBB) or polybrominated diphenyl ethers (PBDE).

Performance Characteristics

Product Selection Guide

Table 1a. Product performance of LUXEON 2835 Colors at 120mA and 200mA, $T_j=25^\circ\text{C}$.

COLOR	DOMINANT or PEAK WAVELENGTH ^[1] (nm)		LUMINOUS FLUX ^[2] (lm) or RADIOMETRIC POWER ^[3] (mW)			PART NUMBER
	MINIMUM	MAXIMUM	MINIMUM	120mA TYPICAL	200mA TYPICAL	
Far Red	720	740	85	98	160	L128-FRD1003500000
Deep Red	650	670	98	110	181	L128-DRD1003500000
Red	620	630	15	20	31	L128-RED1003500000
Red-Orange	610	620	19	27	43	L128-RNG1003500000
PC Red-Orange	-	-	21	24	36	L128-PCO1003500000
PC Amber	-	-	44	52	83	L128-PCA1003500000
Mint	-	-	69	77	120	L128-MNT1003500000
Lime	-	-	70	82	129	L128-LME1003500000
Green	520	540	40	47	62	L128-GRN1003500000
Cyan	490	510	21	30	41	L128-CYN1003500000
Blue	469	480	13	18	27	L128-BLU1003500000
PC Blue	-	-	16	20	30	L128-PCB1003500000
Royal Blue	440	455	185	230	366	L128-RYL1003500000

Notes for Table 1a:

- Lumileds maintains a tolerance of $\pm 1\text{nm}$ on dominant wavelength measurements. PC Amber, PC Red-Orange, Mint, Lime and PC Blue are binned by chromaticity coordinates. Far Red, Deep Red and Royal Blue are binned by peak wavelength. All other colors are binned by dominant wavelength.
- Lumileds maintains a tolerance of $\pm 7.5\%$ on luminous flux measurements.
- Far Red, Deep Red and Royal Blue are binned by radiometric power. All other colors are binned by luminous flux.

Table 1b. Product performance of LUXEON 2835 White at 120mA, $T_j=25^\circ\text{C}$.

COLOR	NOMINAL CCT	MINIMUM CRI ^[1]	LUMINOUS FLUX ^[1] (lm)		TYPICAL LUMINOUS EFFICACY (lm/W)	PART NUMBER
			MINIMUM	TYPICAL		
White	5700K	70	58	68	198	L128-5770003500000
	3000K	80	54	62	182	L128-3080003500000
	4000K	80	56	64	187	L128-4080003500000

Notes for Table 1b:

- Lumileds maintains a tolerance of $\pm 7.5\%$ on luminous flux measurements.

Table 1c. Product performance of LUXEON 2835 Colors 36V at specified test current 20mA, $T_j=25^\circ\text{C}$.

COLOR	DOMINANT or PEAK WAVELENGTH ^[1] (nm)		LUMINOUS FLUX ^[2] (lm) or RADIOMETRIC POWER ^[3] (mW)		PART NUMBER
	MINIMUM	MAXIMUM	MINIMUM	20mA TYPICAL	
PC Red-Orange	615	620	21	27	L128-PCO10L3500000
Lime	563	568	127	139	L128-LME10L3500000
PC Green 1	530	536	126	134	L128-PCG10L3500000
PC Green 2	543	550	134	145	L128-PCG20L3500000
Royal Blue	440	455	357	386	L128-RYL10L3500000

Notes for Table 1c:

- Lumileds maintains a tolerance of $\pm 1\text{nm}$ on dominant wavelength measurements. PC Red-Orange, Lime and PC Green are binned by chromaticity coordinates. Royal Blue is binned by peak wavelength.
- Lumileds maintains a tolerance of $\pm 7.5\%$ on luminous flux measurements.
- Royal Blue are binned by radiometric power. All other colors are binned by luminous flux.

Optical Characteristics

Table 2a. Optical characteristics for LUXEON 2835 Colors at 120mA, T_j=25°C.

COLOR	PART NUMBER	TYPICAL SPECTRAL HALF-WIDTH ^[1] (nm)	TYPICAL TEMPERATURE COEFFICIENT OF WAVELENGTH (nm/°C)	TYPICAL TOTAL INCLUDED ANGLE ^[2]	TYPICAL VIEWING ANGLE ^[3]
Far Red	L128-FRD1003500000	30	0.17	140°	130°
Deep Red	L128-DRD1003500000	20	0.16	140°	130°
Red	L128-RED1003500000	15	0.05	140°	130°
Red-Orange	L128-RNG1003500000	15	0.07	140°	130°
PC Red-Orange	L128-PCO1003500000	75	-0.01	140°	120°
PC Amber	L128-PCA1003500000	95	0.01	140°	120°
Mint	L128-MNT1003500000	110	0.01	140°	120°
Lime	L128-LME1003500000	110	0.01	140°	120°
Green	L128-GRN1003500000	28	0.05	140°	130°
Cyan	L128-CYN1003500000	25	0.03	140°	130°
Blue	L128-BLU1003500000	20	0.03	140°	130°
PC Blue	L128-PCB1003500000	20	0.03	140°	130°
Royal Blue	L128-RYL1003500000	15	0.04	140°	130°

Notes for Table 2a:

- Spectral half-width is the spectral bandwidth at 50% of the peak intensity.
- Total angle at which 90% of total luminous flux is captured.
- Viewing angle is the off axis angle from the LED centerline where the luminous intensity is ½ of the peak value.

Table 2b. Optical characteristics for LUXEON 2835 White at 120mA, T_j=25°C.

COLOR	PART NUMBER	TYPICAL TOTAL INCLUDED ANGLE ^[1]	TYPICAL VIEWING ANGLE ^[1]
White	L128-xxxx0035000000	160°	120°

Notes for Table 2b:

- Total angle at which 90% of total luminous flux is captured.
- Viewing angle is the off axis angle from the LED centerline where the luminous intensity is ½ of the peak value.

Table 2c. Optical characteristics for LUXEON 2835 Colors 36V at specified test current 20mA, T_j=25°C.

COLOR	PART NUMBER	TYPICAL SPECTRAL HALF-WIDTH ^[1] (nm)	TYPICAL TEMPERATURE COEFFICIENT OF WAVELENGTH (nm/°C)	TYPICAL TOTAL INCLUDED ANGLE ^[2]	TYPICAL VIEWING ANGLE ^[3]
PC Red-Orange	L128-PCO10L3500000	83	-0.01	120°	113°
Lime	L128-LME10L3500000	108	0.01	120°	115°
PC Green 1	L128-PCG10L3500000	63	0.02	120°	115°
PC Green 2	L128-PCG20L3500000	67	0.01	120°	115°
Royal Blue	L128-RYL10L3500000	17	0.04	125°	129°

Notes for Table 2c:

- Spectral half-width is the spectral bandwidth at 50% of the peak intensity.
- Total angle at which 90% of total luminous flux is captured.
- Viewing angle is the off axis angle from the LED centerline where the luminous intensity is ½ of the peak value.

Electrical and Thermal Characteristics

Table 3a. Electrical and thermal characteristics for LUXEON 2835 Color Line at 120mA, T_j=25°C.

COLOR	PART NUMBER	FORWARD VOLTAGE ^[1] (V _f)			TYPICAL TEMPERATURE COEFFICIENT OF FORWARD VOLTAGE ^[2] (mV/°C)	TYPICAL THERMAL RESISTANCE — JUNCTION TO SOLDER PAD (°C/W)
		MINIMUM	TYPICAL	MAXIMUM		
Far Red	L128-FRD1003500000	1.80	2.15	2.50	-2.0	15
Deep Red	L128-DRD1003500000	1.80	2.15	2.50	-2.0	15
Red	L128-RED1003500000	1.80	2.10	2.50	-2.0	15
Red-Orange	L128-RNG1003500000	1.80	2.10	2.50	-1.7	15
PC Red-Orange	L128-PCO1003500000	2.80	3.00	3.10	-1.7	25
PC Amber	L128-PCA1003500000	2.80	3.00	3.10	-1.7	25
Mint	L128-MNT1003500000	2.80	3.00	3.10	-2.5	25
Lime	L128-LME1003500000	2.80	3.00	3.10	-1.7	25
Green	L128-GRN1003500000	2.80	3.15	3.30	-3.0	69
Cyan	L128-CYN1003500000	2.80	3.10	3.30	-2.5	50
Blue	L128-BLU1003500000	2.80	3.00	3.20	-2.5	25
PC Blue	L128-PCB1003500000	2.80	3.00	3.20	-2.5	25
Royal Blue	L128-RYL1003500000	2.80	3.00	3.20	-2.5	25
White	L128-xxx003500000	2.70	2.85	3.00	-1.0 to -2.0	13

Notes for Table 3a:

1. Lumileds maintains a tolerance of ±0.1V on forward voltage measurements.
2. Measured between 25°C and 85°C.

Table 3b. Electrical and thermal characteristics for LUXEON 2835 Color 36V at 20mA, T_j=25°C.

COLOR	PART NUMBER	FORWARD VOLTAGE ^[1] (V _f)			TYPICAL TEMPERATURE COEFFICIENT OF FORWARD VOLTAGE ^[2] (mV/°C)	TYPICAL THERMAL RESISTANCE — JUNCTION TO SOLDER PAD (°C/W)
		MINIMUM	TYPICAL	MAXIMUM		
PC Red-Orange	L128-PCO10L3500000	35.0	36.3	37.5	-19.8	15.4
Lime	L128-LME10L3500000	35.0	36.3	37.5	-21.3	13.2
PC Green 1	L128-PCG10L3500000	35.0	36.3	37.5	-22.9	13.5
PC Green 2	L128-PCG20L3500000	35.0	36.3	37.5	-20.2	13.5
Royal Blue	L128-RYL10L3500000	35.0	36.3	37.5	-20.1	10.5

Notes for Table 3b:

1. Lumileds maintains a tolerance of ±0.1V on forward voltage measurements.
2. Measured between 25°C and 85°C.

Absolute Maximum Ratings

Table 4a. Absolute maximum ratings for LUXEON 2835 Color Line.

PARAMETER	FAR RED	DEEP RED, RED and RED-ORANGE	PC RED-ORANGE, PC AMBER, MINT, LIME, GREEN, CYAN, BLUE, PC BLUE and ROYAL BLUE	WHITE
DC Forward Current ^[1,2]	300mA	250mA	240mA	480mA
Peak Pulsed Forward Current ^[1,3]	350mA	300mA	300mA	500mA
LED Junction Temperature ^[1] (DC & Pulse)	125°C	125°C	125°C	125°C
ESD Sensitivity (ANSI/ESDA/JEDEC JS-001-2012)	Class 2	Class 2	Class 2	Class 2
Operating Case Temperature ^[1]	105°C	105°C	105°C	105°C
LED Storage Temperature	-40°C to 105°C	-40°C to 105°C	-40°C to 95°C	-40°C to 105°C
Soldering Temperature	JEDEC 020c 260°C			
Allowable Reflow Cycles	3			
Reverse Voltage ($V_{reverse}$)	LUXEON LEDs are not designed to be driven in reverse bias			

Notes for Table 4a:

- Proper current derating must be observed to maintain the junction temperature below the maximum allowable junction temperature.
- Residual periodic variations due to power conversion from alternating current (AC) to direct current (DC), also called "ripple," are acceptable if the following conditions are met:
 - The frequency of the ripple current is 100Hz or higher
 - The average current for each cycle does not exceed the maximum allowable DC forward current
 - The maximum amplitude of the ripple does not exceed the maximum peak pulsed forward current
- At 10% duty cycle with pulse width of 10ms.

Table 4b. Absolute maximum ratings for LUXEON 2835 Color 36V.

PARAMETER	PC RED-ORANGE, PC GREEN, LIME	ROYAL BLUE
DC Forward Current ^[1,2]	25mA	20mA
Peak Pulsed Forward Current ^[1,3]	30mA	30mA
LED Junction Temperature ^[1] (DC & Pulse)	125°C	
ESD Sensitivity (ANSI/ESDA/JEDEC JS-001-2012)	Class 2	
Operating Case Temperature ^[1]	105°C	
LED Storage Temperature	-40°C to 85°C	
Soldering Temperature	JEDEC 020c 260°C	
Allowable Reflow Cycles	3	
Reverse Voltage ($V_{reverse}$)	LUXEON LEDs are not designed to be driven in reverse bias	

Notes for Table 4b:

- Proper current derating must be observed to maintain the junction temperature below the maximum allowable junction temperature.
- Residual periodic variations due to power conversion from alternating current (AC) to direct current (DC), also called "ripple," are acceptable if the following conditions are met:
 - The frequency of the ripple current is 100Hz or higher
 - The average current for each cycle does not exceed the maximum allowable DC forward current
 - The maximum amplitude of the ripple does not exceed the maximum peak pulsed forward current
- At 10% duty cycle with pulse width of 10ms.

Characteristic Curves

Spectral Power Distribution Characteristics

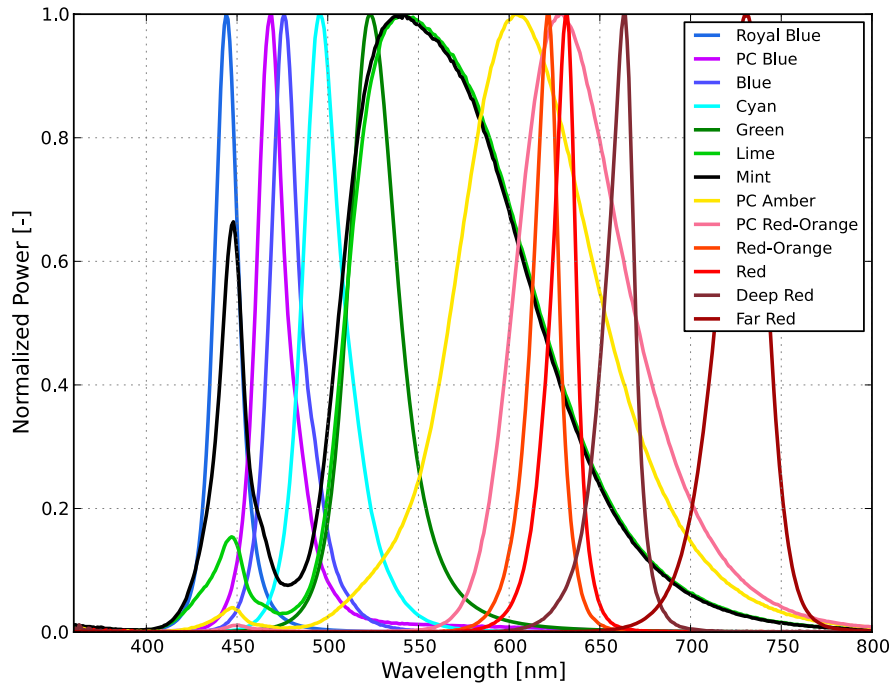

Figure 1a. Typical normalized power vs. wavelength for LUXEON 2835 Colors at 120mA, $T_j=25^{\circ}\text{C}$.

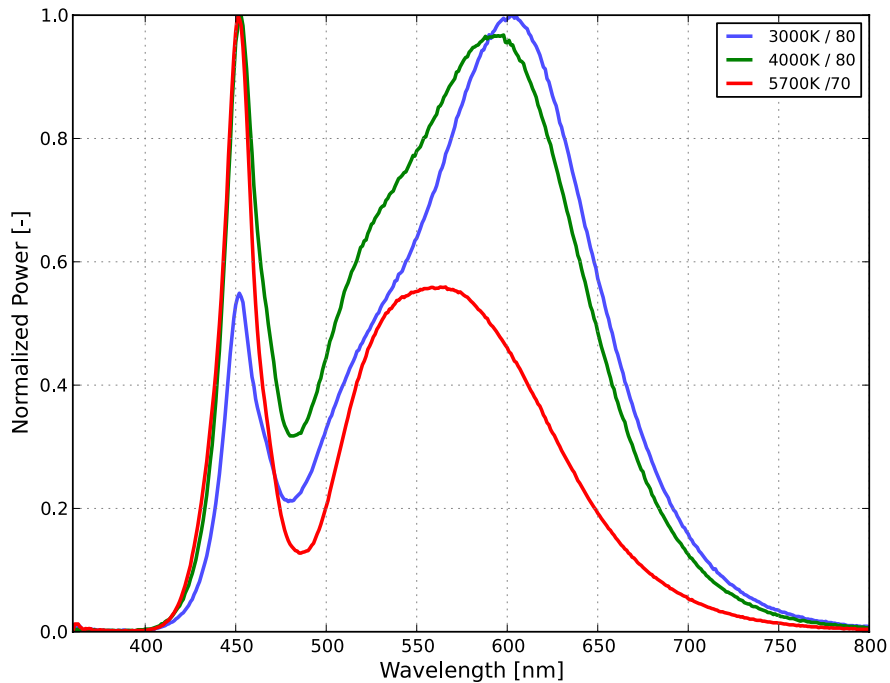

Figure 1b. Typical normalized power vs. wavelength for LUXEON 2835 White at 120mA, $T_j=25^{\circ}\text{C}$.

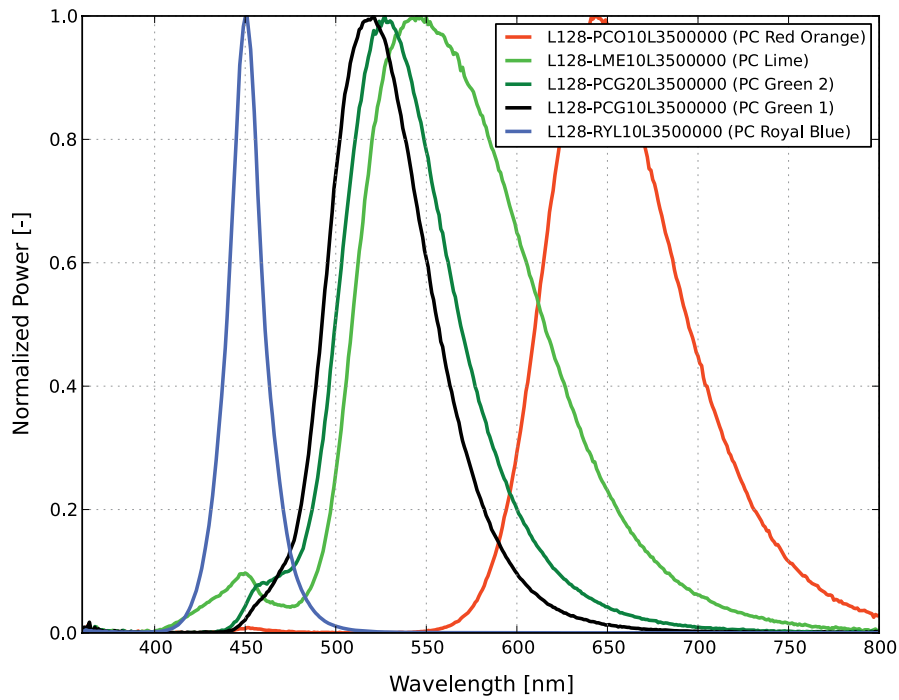

Figure 1c. Typical normalized power vs. wavelength for LUXEON 2835 Colors 36V at 20mA, $T_j=25^\circ\text{C}$.

Light Output Characteristics

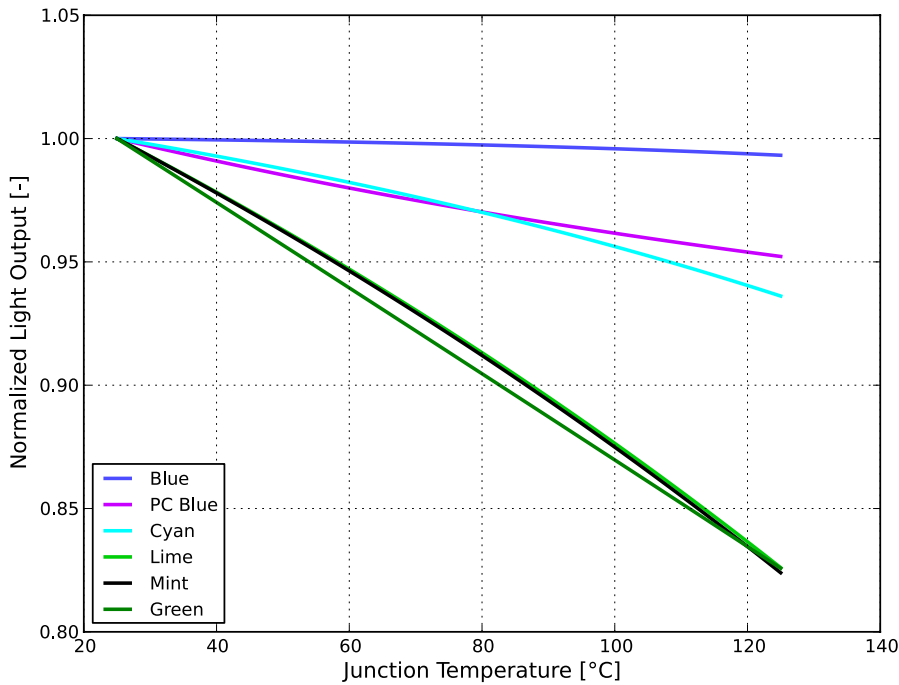

Figure 2a. Typical normalized light output vs. junction temperature for LUXEON 2835 Mint, Lime, Green, Cyan, Blue and PC Blue at 120mA.

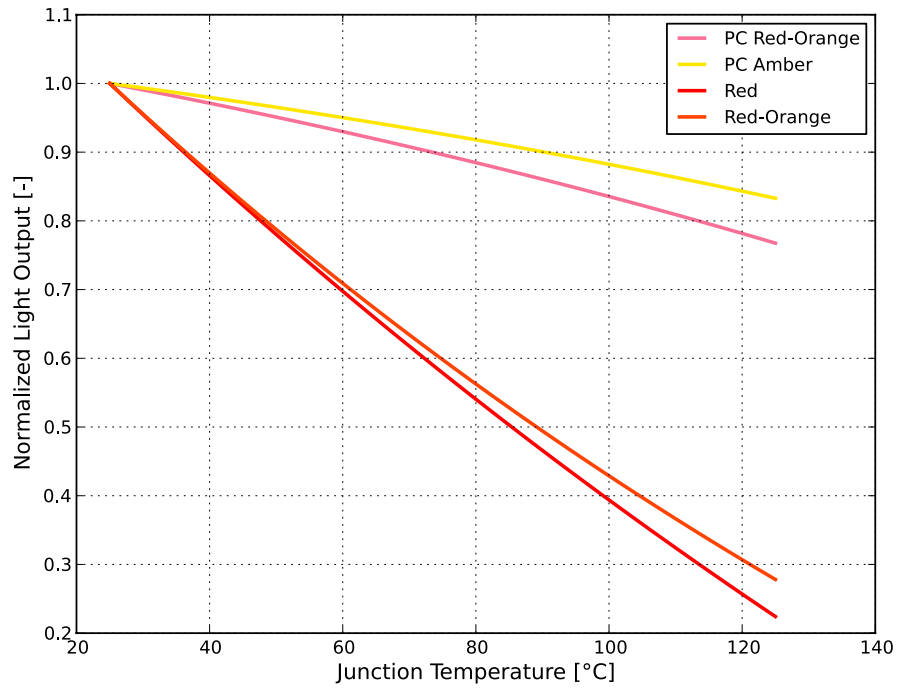

Figure 2b. Typical normalized light output vs. junction temperature for LUXEON 2835 Red, Red-Orange, PC Red-Orange, and PC Amber at 120mA.

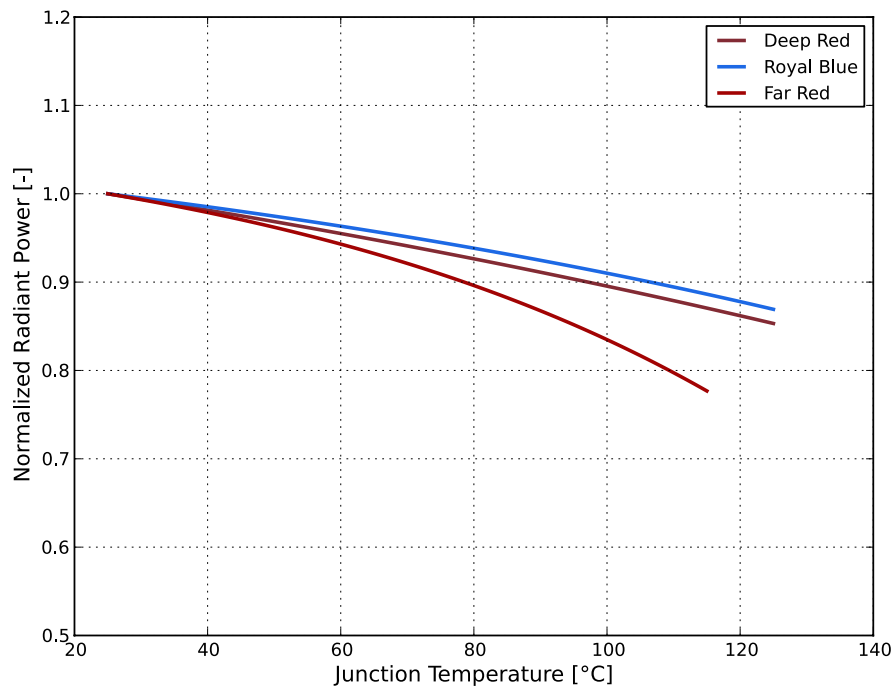

Figure 2c. Typical normalized radiant power vs. junction temperature for LUXEON 2835 Far Red, Deep Red, and Royal Blue at 120mA.

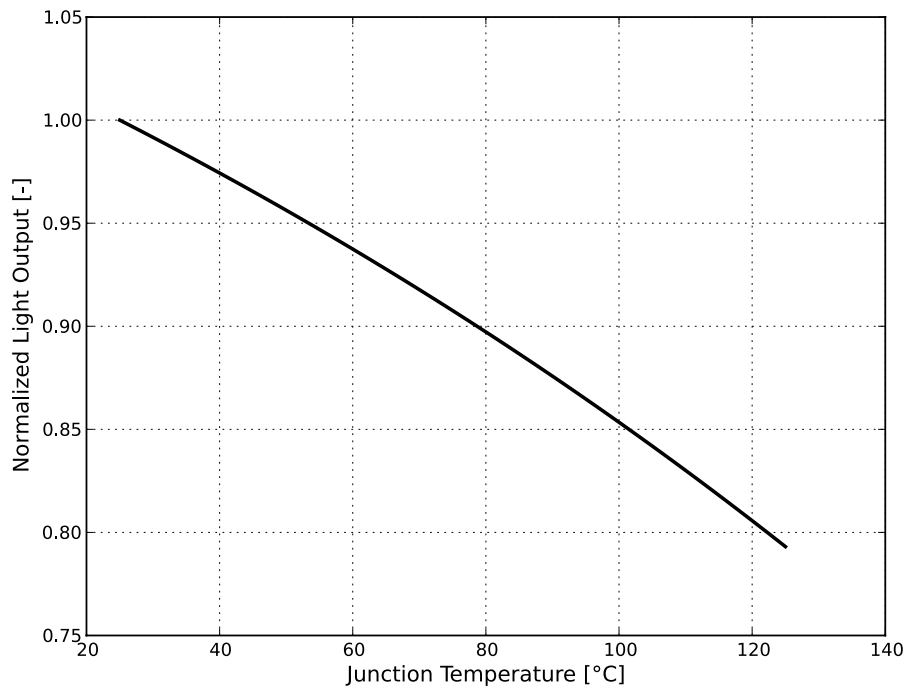

Figure 2d. Typical normalized light output vs. junction temperature for LUXEON 2835 White at 120mA.

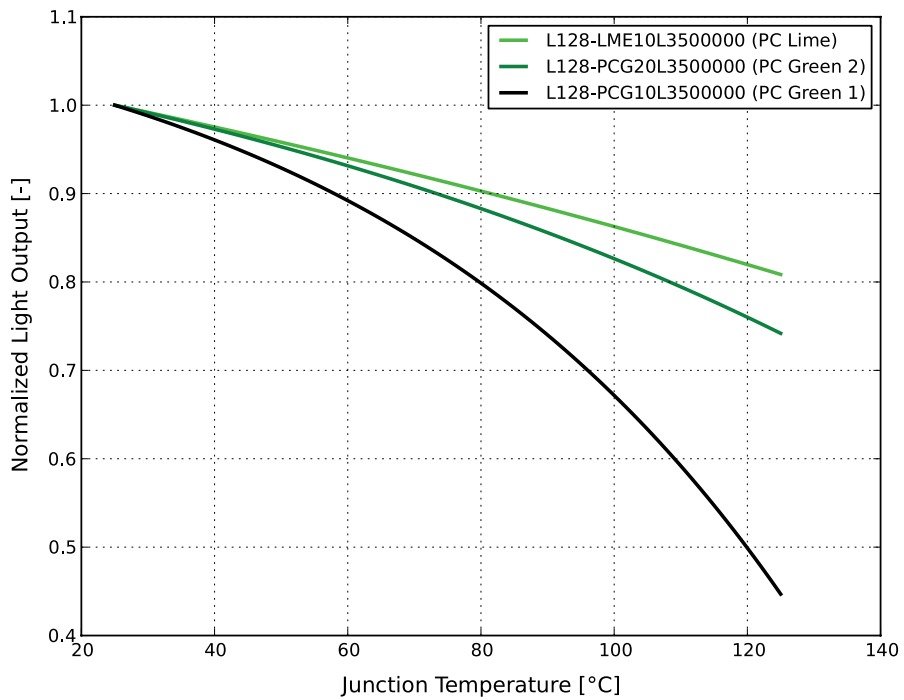

Figure 2e. Typical normalized light output vs. junction temperature for LUXEON 2835 36V Lime, PC Green 2 and PC Green 1 at 20mA.

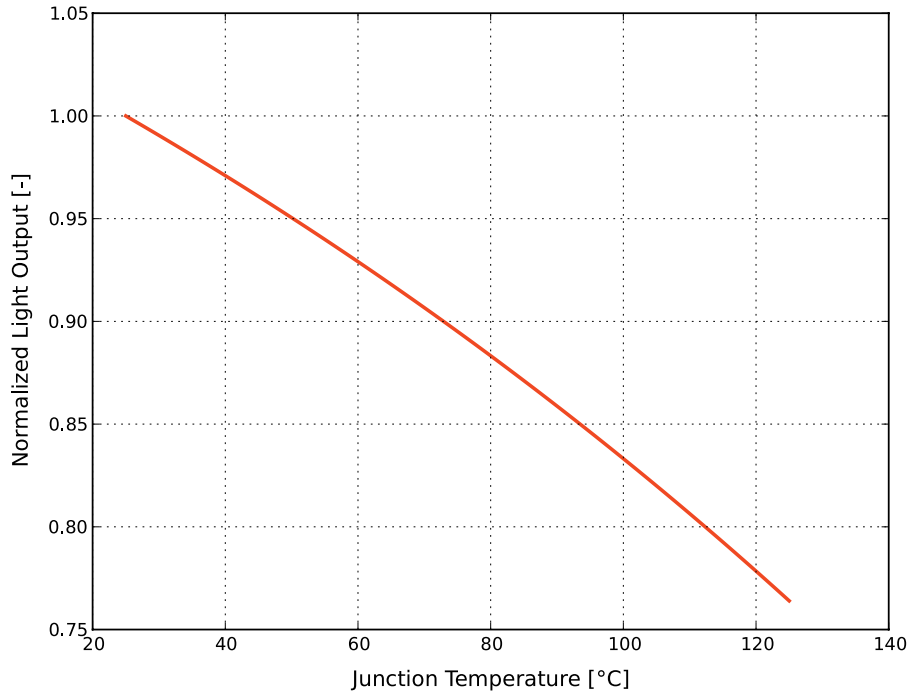

Figure 2f. Typical normalized light output vs. junction temperature for LUXEON 2835 36V PC Red-Orange at 20mA.

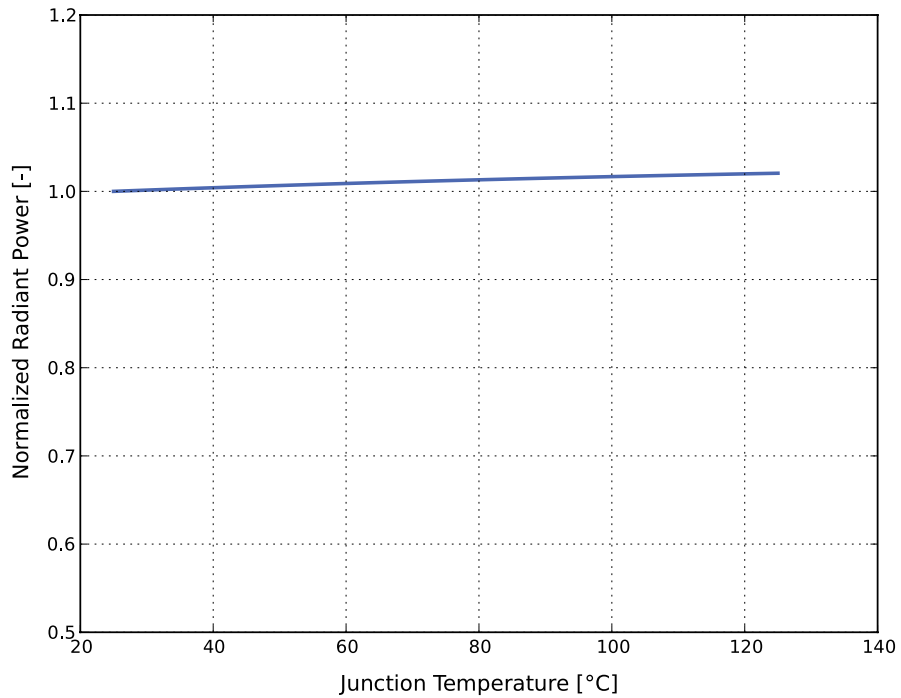

Figure 2g. Typical normalized radiant power vs. junction temperature for LUXEON 2835 36V Royal Blue at 20mA.

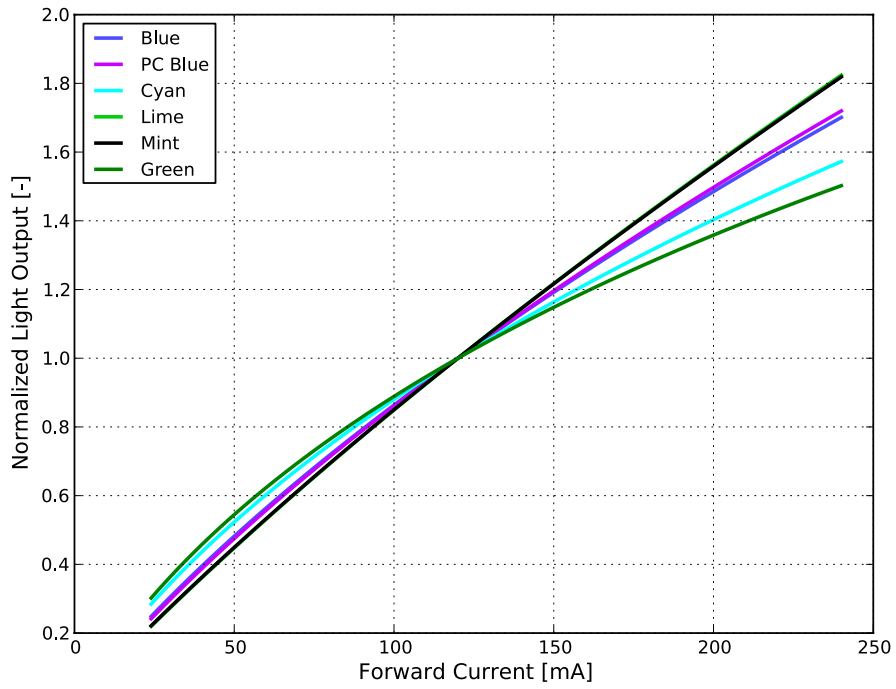

Figure 3a. Typical normalized light output vs. forward current for LUXEON 2835 Mint, Lime, Green, Cyan, Blue and PC Blue at $T_j=25^\circ\text{C}$.

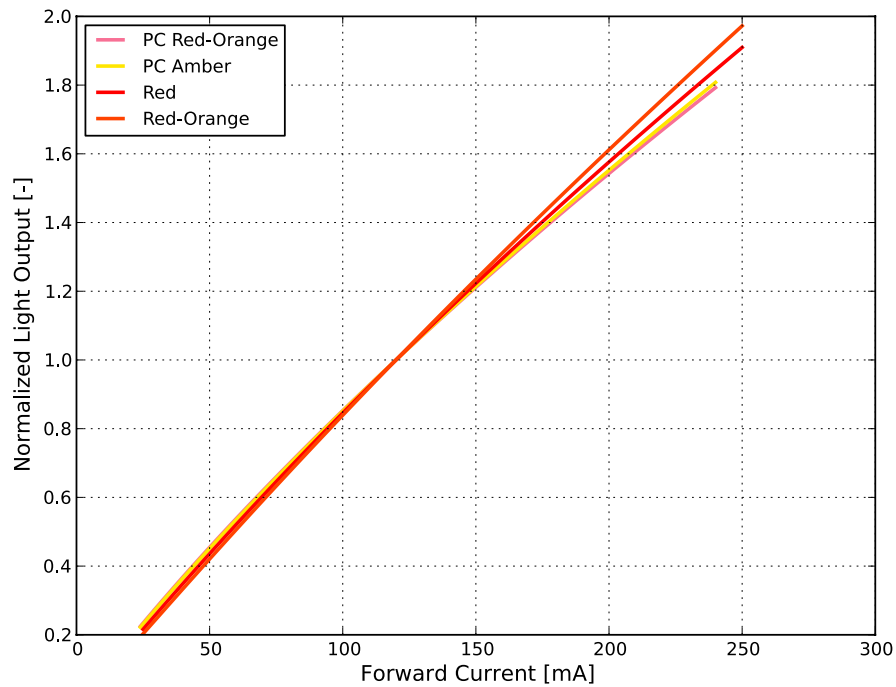

Figure 3b. Typical normalized light output vs. forward current for LUXEON 2835 Red, Red-Orange, PC Red-Orange, and PC Amber at $T_j=25^\circ\text{C}$.

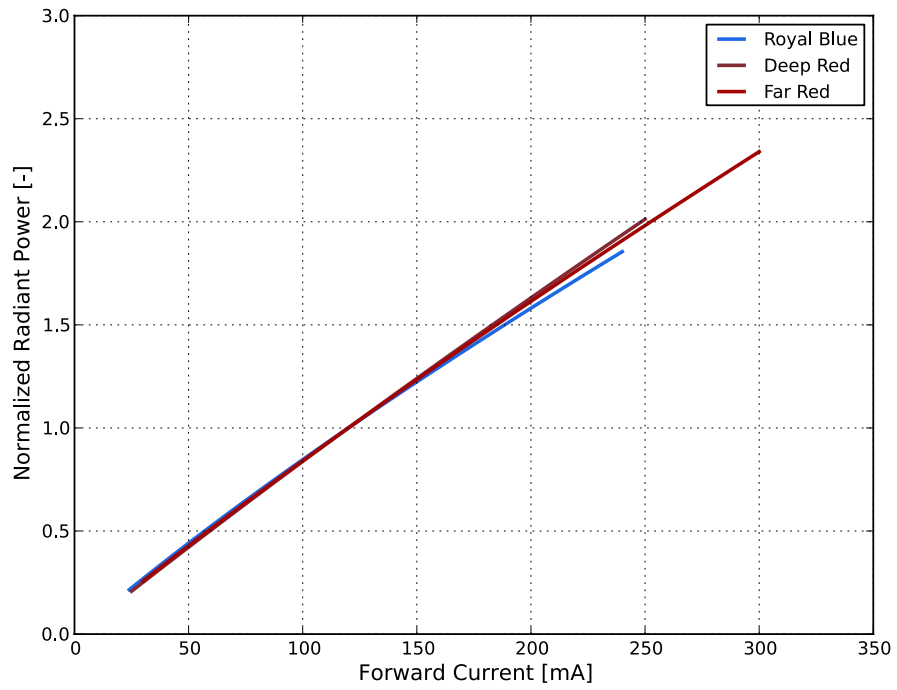

Figure 3c. Typical normalized radiant power vs. forward current for LUXEON 2835 Far Red, Deep Red, and Royal Blue at $T_j=25^\circ\text{C}$.

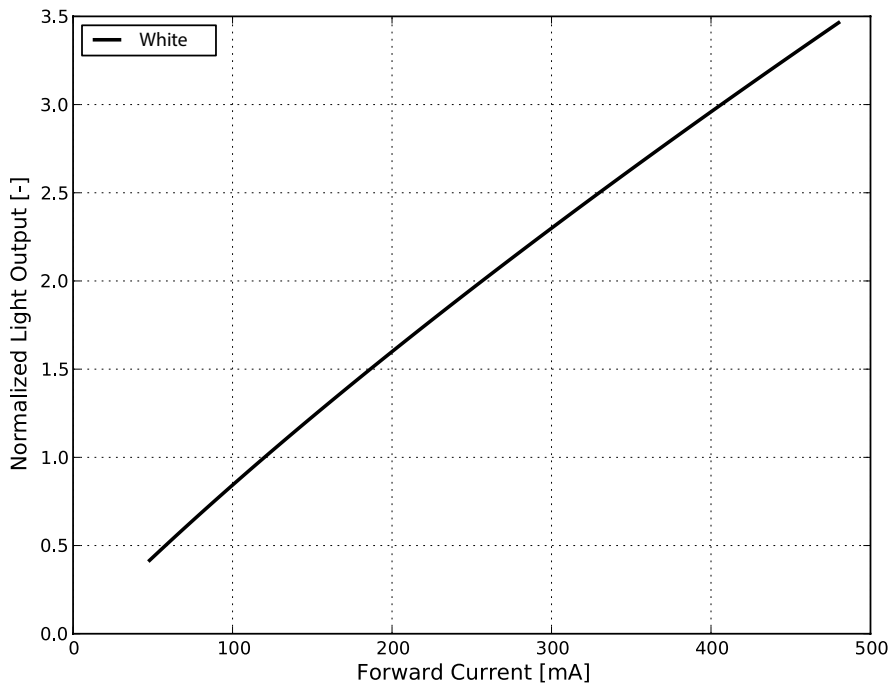

Figure 3d. Typical normalized light output vs. forward current for LUXEON 2835 White at $T_j=25^\circ\text{C}$.

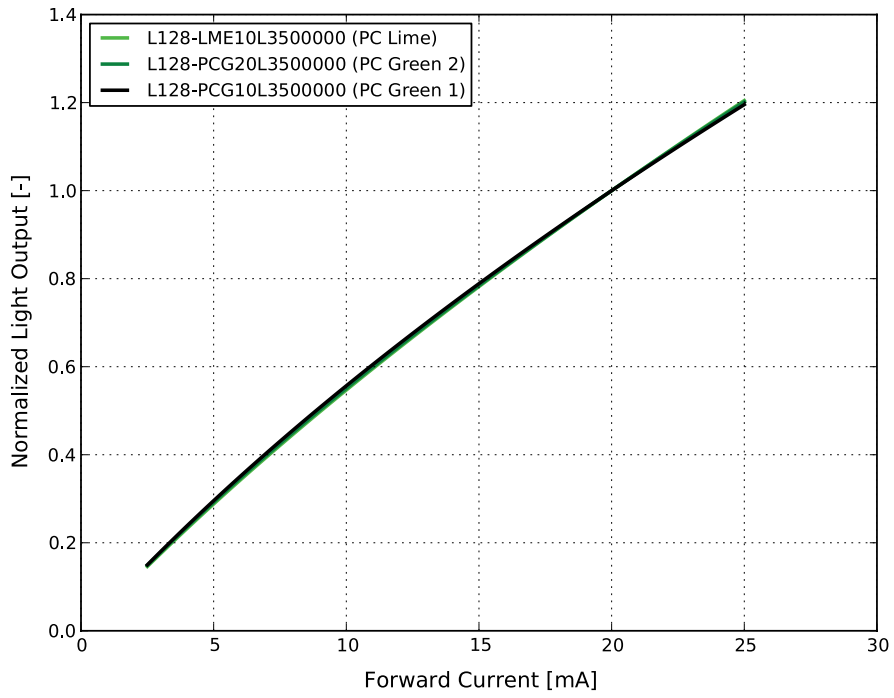

Figure 3e. Typical normalized light output vs. forward current for LUXEON 2835 36V Lime, PC Green 2 and PC Green 1 at $T_j=25^\circ\text{C}$.

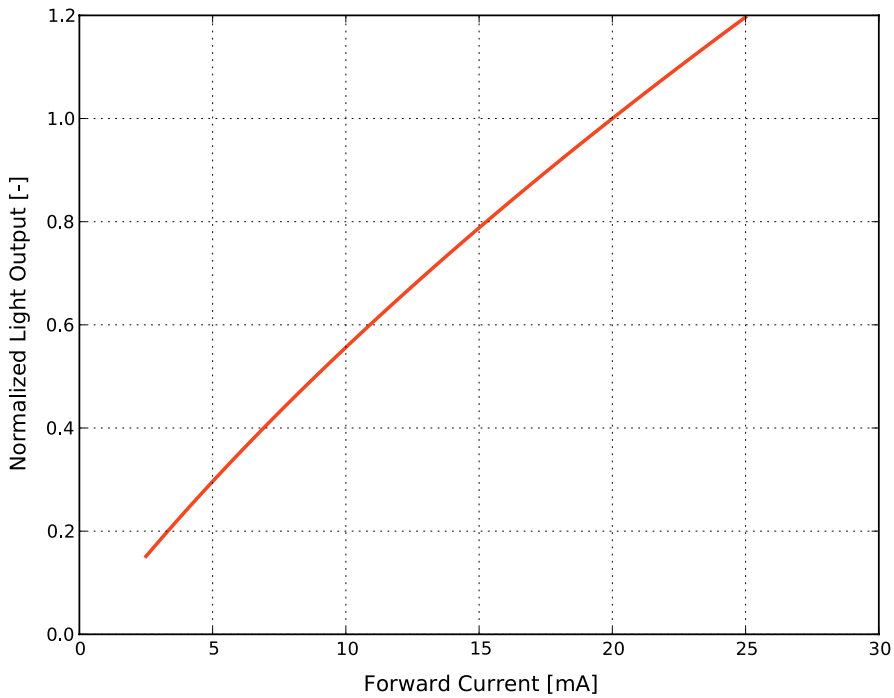

Figure 3f. Typical normalized light output vs. forward current for LUXEON 2835 36V PC Red-Orange at $T_j=25^\circ\text{C}$.

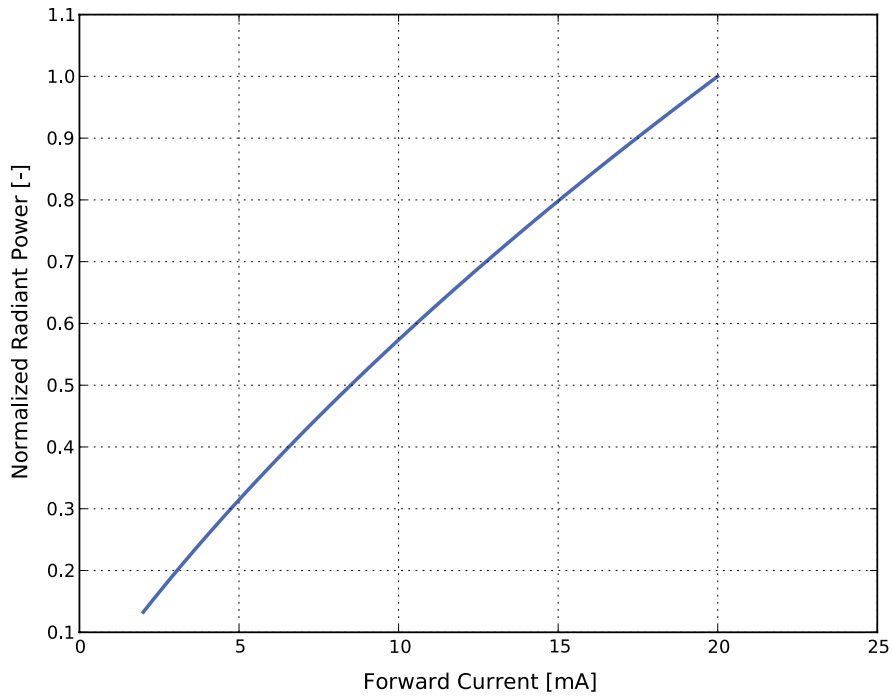

Figure 3g. Typical normalized radiant power vs. forward current for LUXEON 2835 36V Royal Blue at T_j=25°C.

Forward Current Characteristics

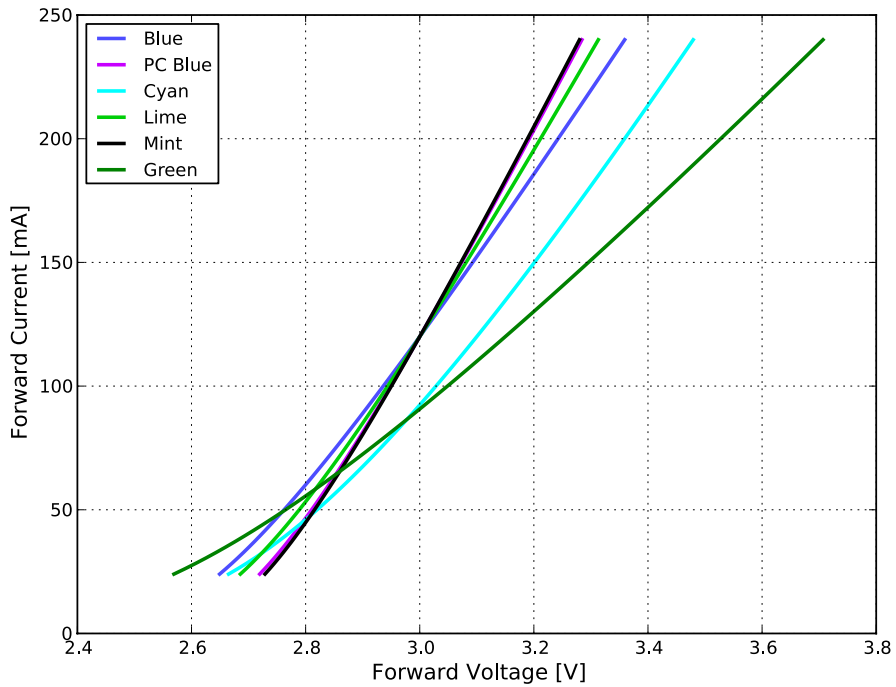

Figure 4a. Typical forward current vs. forward voltage for LUXEON 2835 Mint, Lime, Green, Cyan, Blue and PC Blue at T_j=25°C.

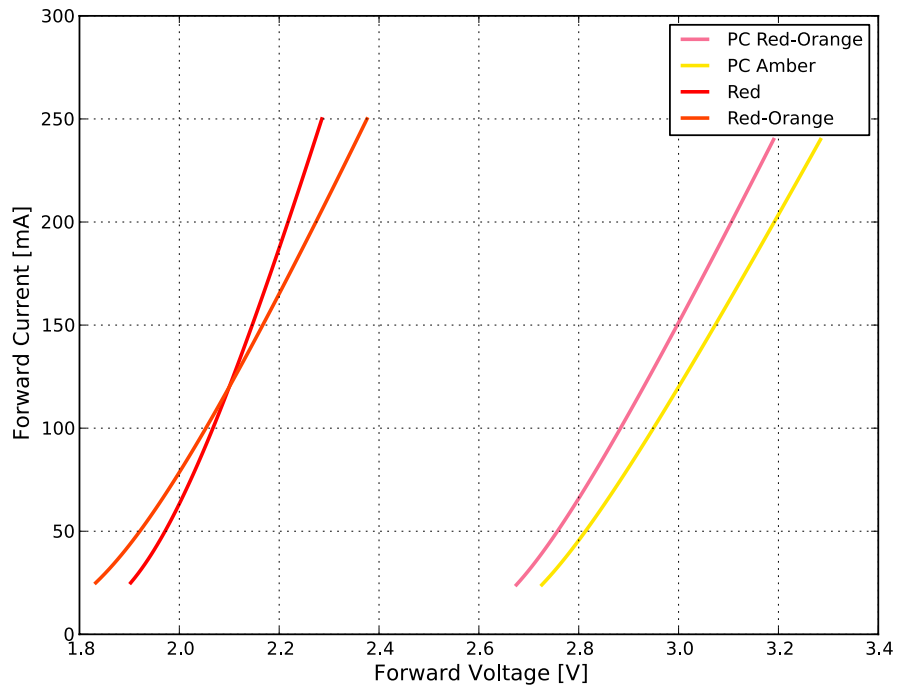

Figure 4b. Typical forward current vs. forward voltage for LUXEON 2835 Red, Red-Orange, and PC Amber at T_j=25°C.

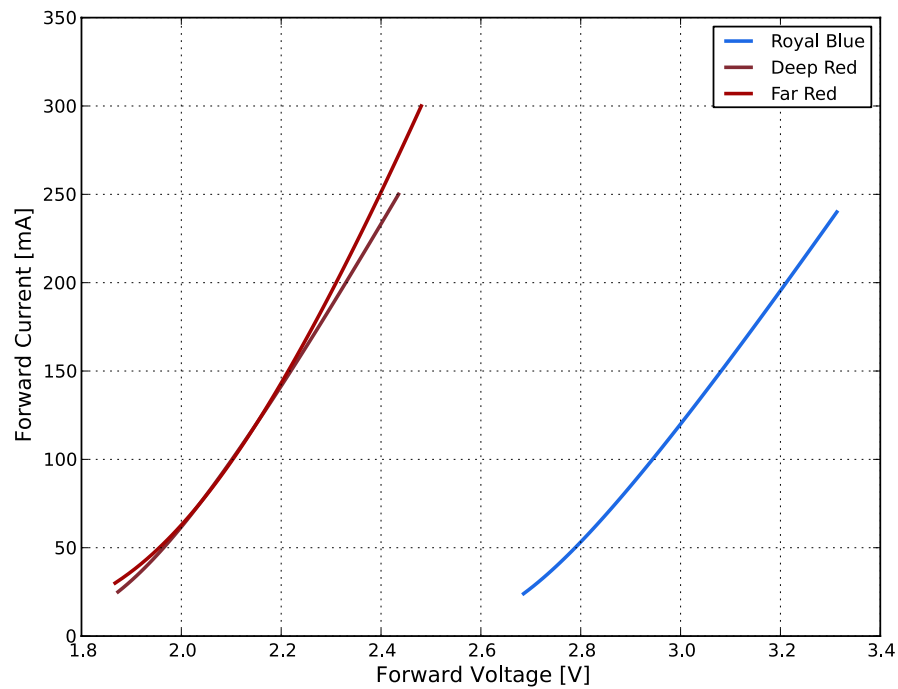

Figure 4c. Typical forward current vs. forward voltage for LUXEON 2835 Far Red, Deep Red, and Royal Blue at T_j=25°C.

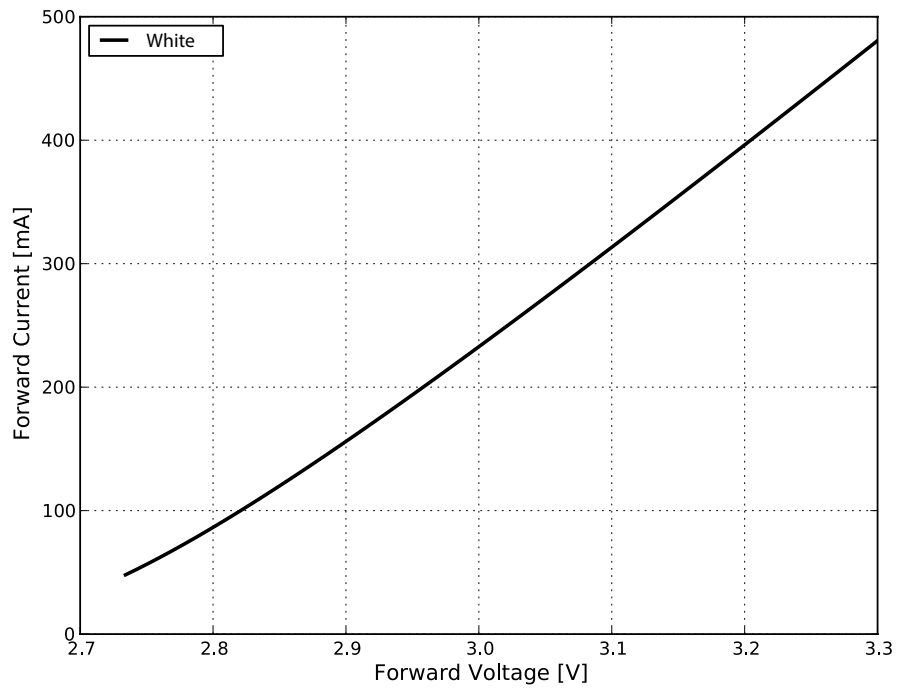

Figure 4d. Typical forward current vs. forward voltage for LUXEON 2835 White at $T_j=25^\circ\text{C}$.

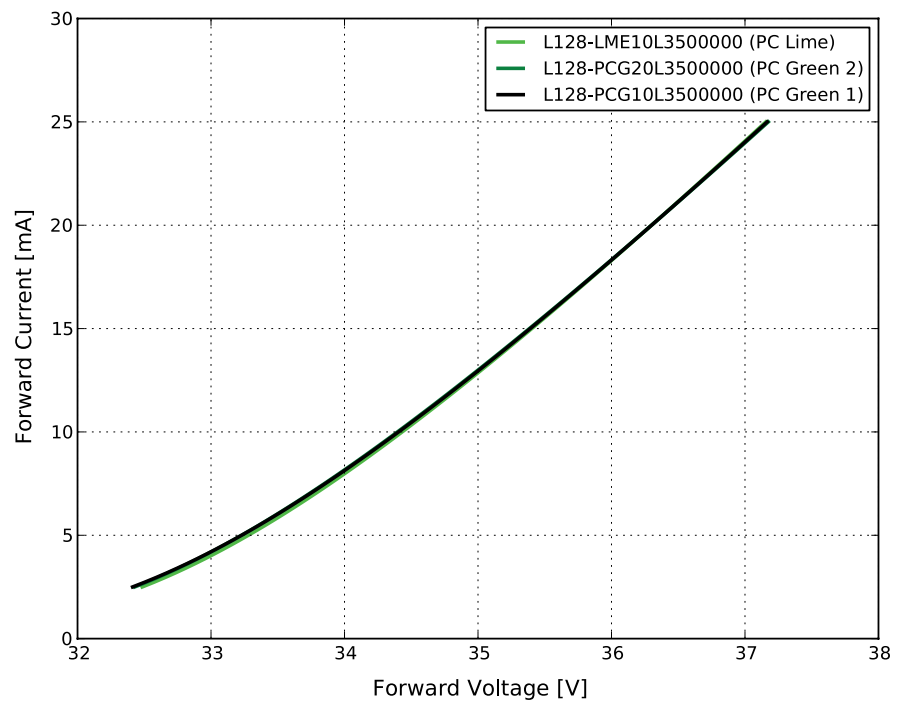

Figure 4e. Typical forward current vs. forward voltage for LUXEON 2835 36V Lime, PC Green 2 and PC Green 1 at $T_j=25^\circ\text{C}$.

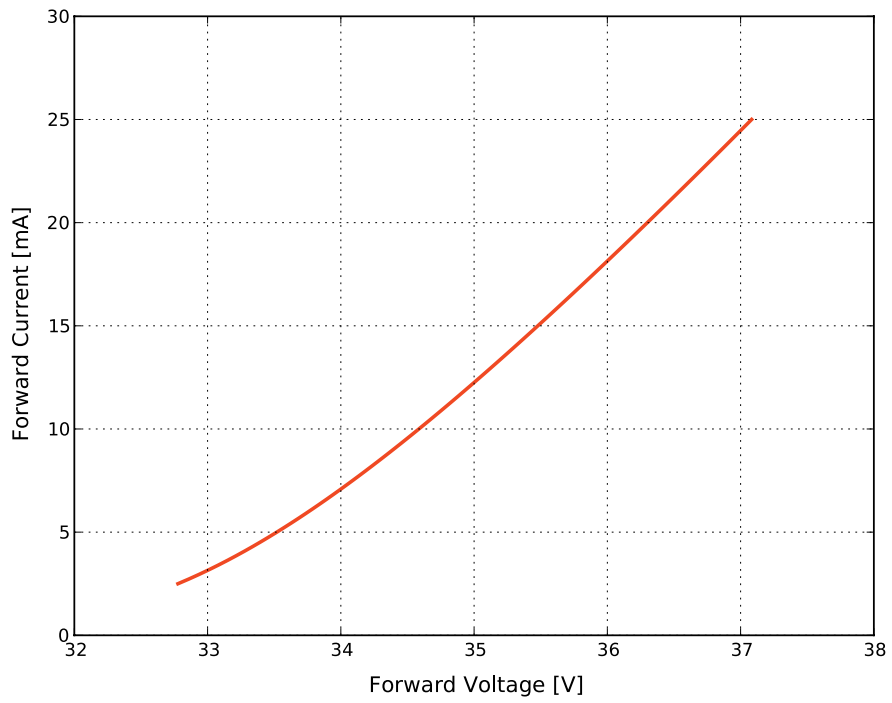

Figure 4f. Typical forward current vs. forward voltage for LUXEON 2835 36V PC Red-Orange at $T_j=25^\circ\text{C}$.

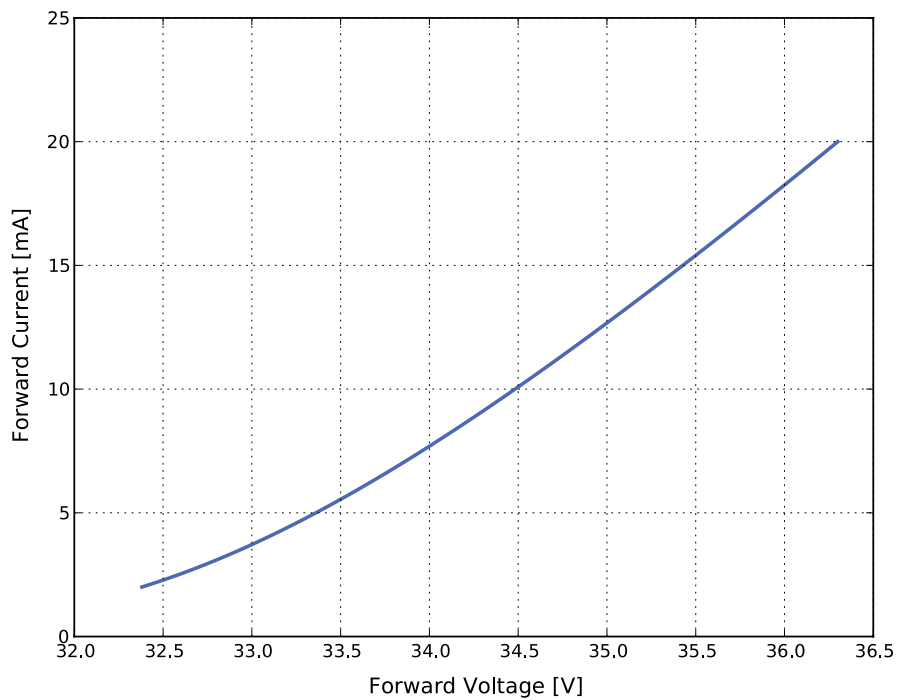

Figure 4g. Typical forward current vs. forward voltage for LUXEON 2835 36V Royal Blue at $T_j=25^\circ\text{C}$.

Radiation Pattern Characteristics

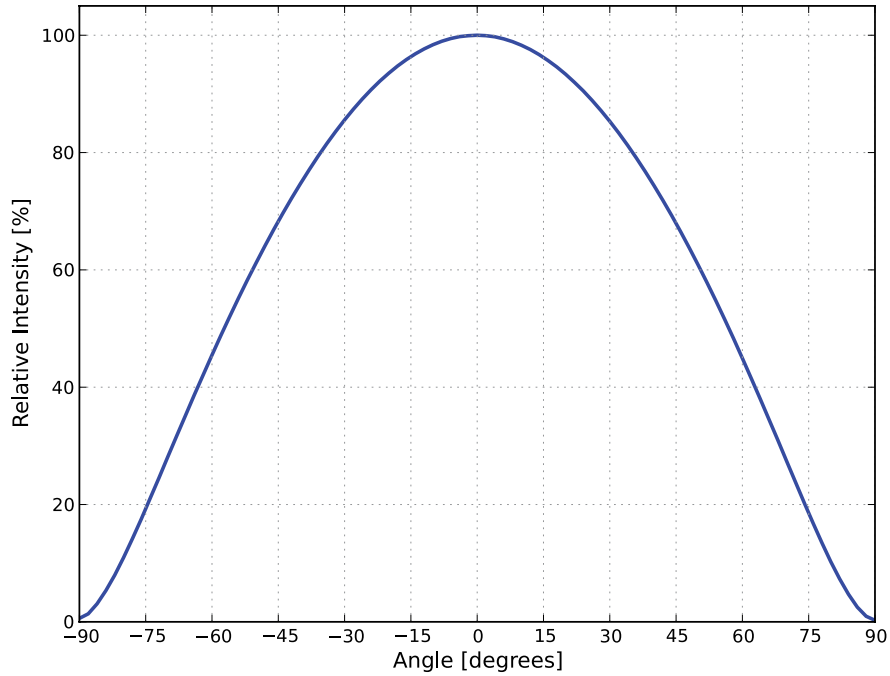

Figure 5a. Typical radiation pattern for LUXEON 2835 Color Line at 120mA, $T_j=25^\circ\text{C}$.

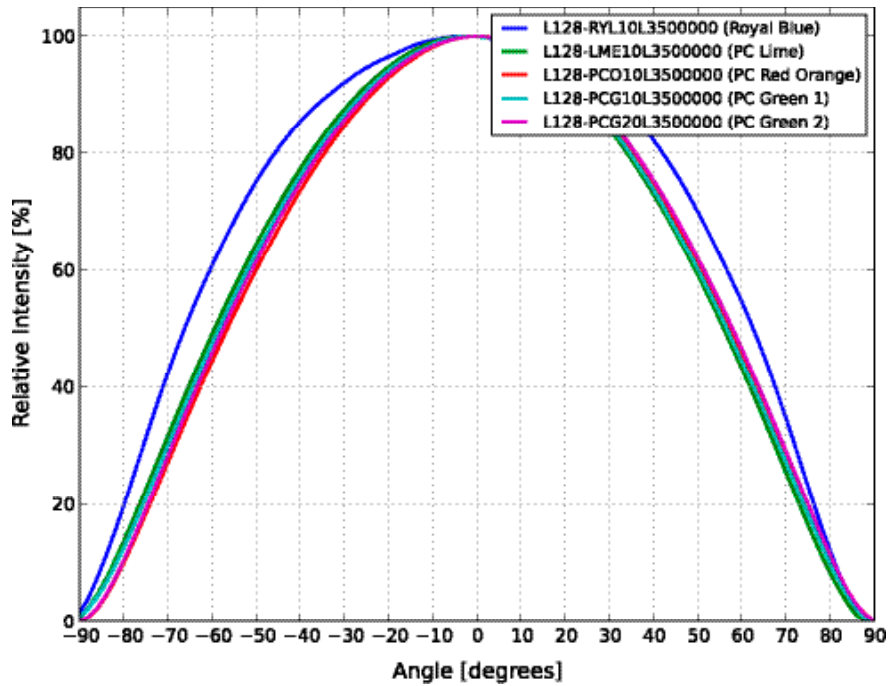

Figure 5b. Typical radiation pattern for LUXEON 2835 Color 36V at 20mA, $T_j=25^\circ\text{C}$.

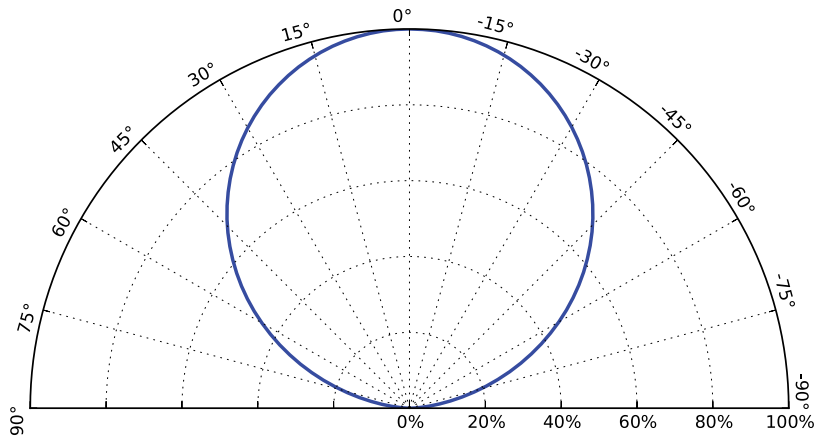

Figure 6a. Typical polar radiation pattern for LUXEON 2835 Color Line at 120mA, $T_j=25^\circ\text{C}$.

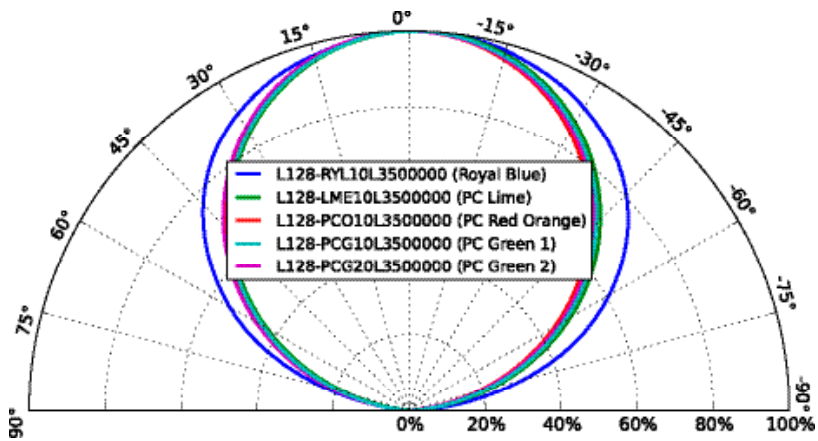

Figure 6b. Typical polar radiation pattern for LUXEON 2835 Color 36V at 20mA, $T_j=25^\circ\text{C}$.

Product Bin and Labeling Definitions

Decoding Product Bin Labeling

In the manufacturing of semiconductor products, there are variations in performance around the average values given in the technical datasheet. For this reason, Lumileds bins LED components for luminous flux or radiometric power, color point, peak or dominant wavelength and forward voltage.

LUXEON 2835 Color Line LEDs are labeled using a 4-digit alphanumeric CAT code following the format below:

A B C D

Where:

- A** – designates luminous flux bin or radiometric power bin (luminous flux bin example: L=32.0 to 36.0 lm, R=52.0 to 56.0 lm; radiometric power bin example: D=100 to 110mW)
- B C** – designates color bin, peak wavelength bin or dominant wavelength bin (color bin examples: Lime=20, White 3000K example=7D, 7E, 7F, etc.; peak wavelength bin example: Deep Red 10=650 to 670nm; dominant wavelength bin example: Red 40=620 to 630nm)
- D** – designates forward voltage bin (example: A=2.80 to 2.90V, C=3.00 to 3.10V)

Therefore, a LUXEON 2835 Lime LED with a lumen range of 32.0 to 36.0 lumens, color bin of 20 and a forward voltage range of 3.00 to 3.10V has the following CAT code:

L 2 0 C

Luminous Flux Bins

Tables 5a, 5b and 5c list the standard luminous flux bins for LUXEON 2835 Color Line emitters. Although several bins are outlined, product availability in a particular bin varies by production run and by product performance. Not all bins are available in all CCTs.

Table 5a. Luminous flux bin definitions for LUXEON 2835 Color Line at $T_j=25^\circ\text{C}$.

BIN	LUMINOUS FLUX ^[1] (lm)	
	MINIMUM	MAXIMUM
D	13	15
E	15	17
F	17	19
G	19	21
H	21	24
J	24	28
K	28	32
L	32	36
M	36	40
N	40	44
P	44	48
Q	48	52
R	52	56
S	56	60
T	60	65
U	65	70
V	70	75
W	75	80
X	80	85
Y	85	90

Notes for Table 5a:

1. Lumileds maintains a tolerance of $\pm 7.5\%$ on luminous flux measurements.

Table 5b. Luminous flux bin definitions for LUXEON 2835 Color 36V PC Red-Orange at $T_j=25^\circ\text{C}$.

BIN	LUMINOUS FLUX ^[1] (lm)	
	MINIMUM	MAXIMUM
H	21	24
J	24	28
K	28	32

Notes for Table 5b:

1. Lumileds maintains a tolerance of $\pm 7.5\%$ on luminous flux measurements.

Table 5c. Luminous flux bin definitions for LUXEON 2835 Color 36V Lime and PC Green at $T_j=25^\circ\text{C}$.

BIN	LUMINOUS FLUX ^[1] (lm)	
	MINIMUM	MAXIMUM
P	120	130
Q	130	140
R	140	150
S	150	160

Notes for Table 5c:

1. Lumileds maintains a tolerance of $\pm 7.5\%$ on luminous flux measurements.

Radiometric Power Bins

Table 6a. Radiometric power bin definitions for LUXEON 2835 Far Red, Deep Red and Royal Blue.

BIN	RADIOMETRIC POWER ^[1] (mW)	
	MINIMUM	MAXIMUM
A	70	80
B	80	90
C	90	100
D	100	110
E	110	120
F	120	130
G	130	150
H	150	170
J	170	190
K	190	210
L	210	230
M	230	250

Notes for Table 6a:

1. Lumileds maintains a tolerance of $\pm 6.5\%$ on radiometric power measurements.

Table 6b. Radiometric power bin definitions for LUXEON 2835 Far Red, Deep Red and Royal Blue.

BIN	RADIOMETRIC POWER ^[1] (mW)	
	MINIMUM	MAXIMUM
A	340	370
B	370	400
C	400	430

Notes for Table 6b:

1. Lumileds maintains a tolerance of $\pm 6.5\%$ on radiometric power measurements.

Color Bin Definitions

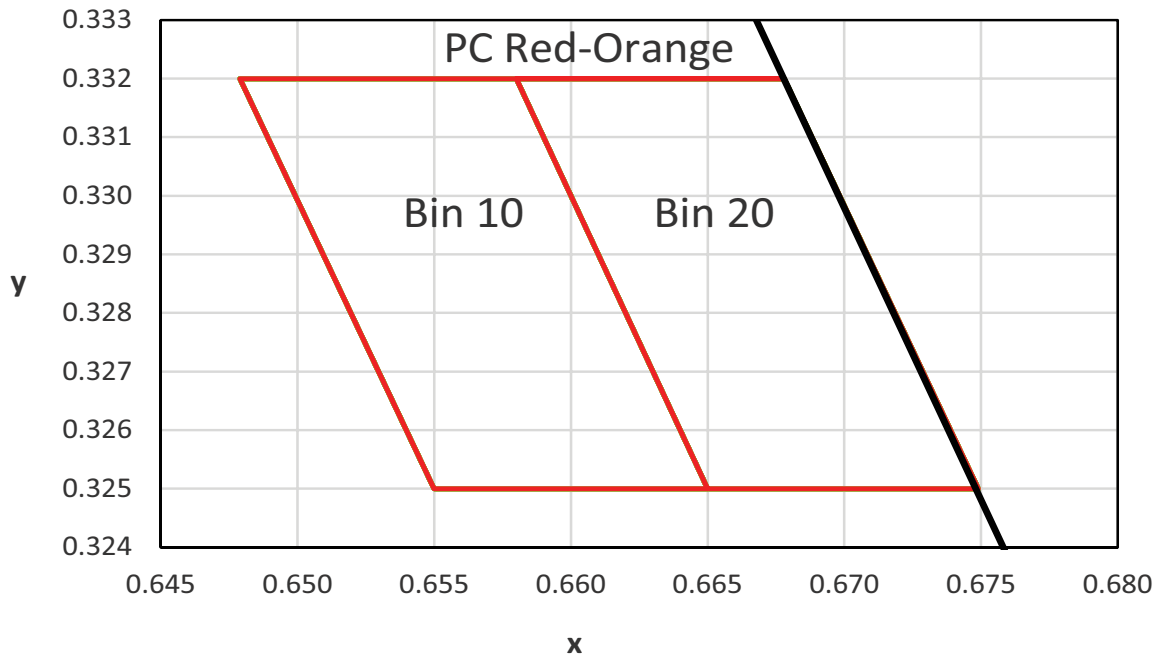

Figure 7. Color Bin Structure for LUXEON 2835 PC Red-Orange for Table 7.

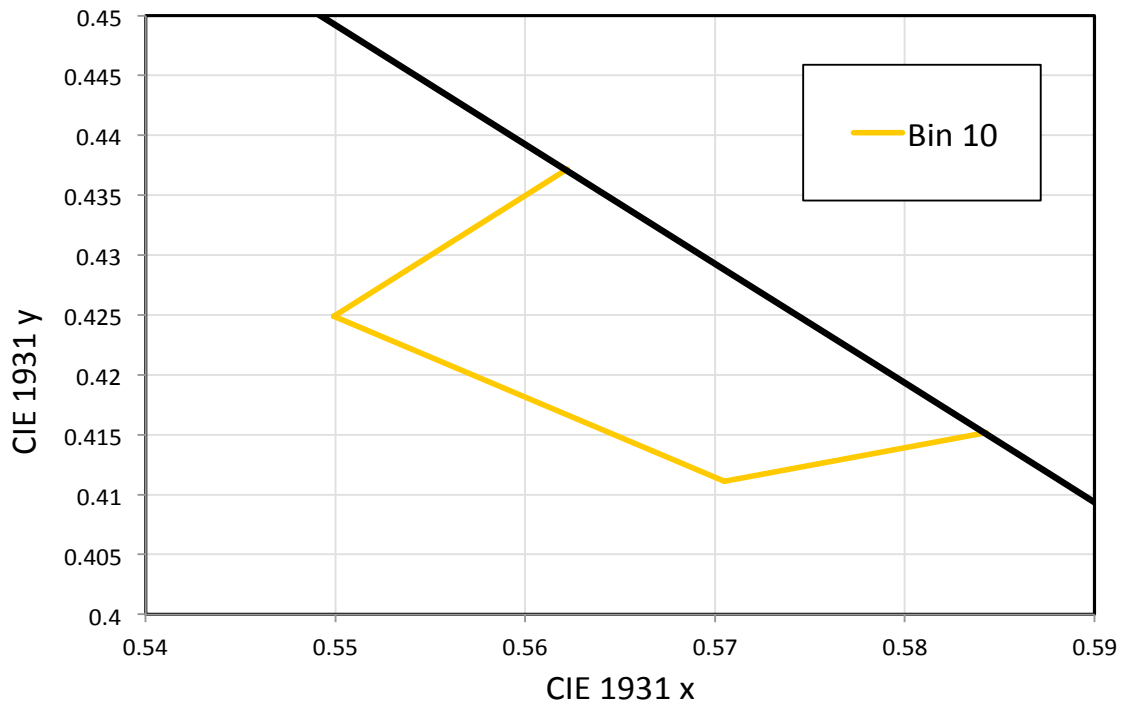

Figure 8. Color Bin Structure for LUXEON 2835 PC Amber for Table 7.

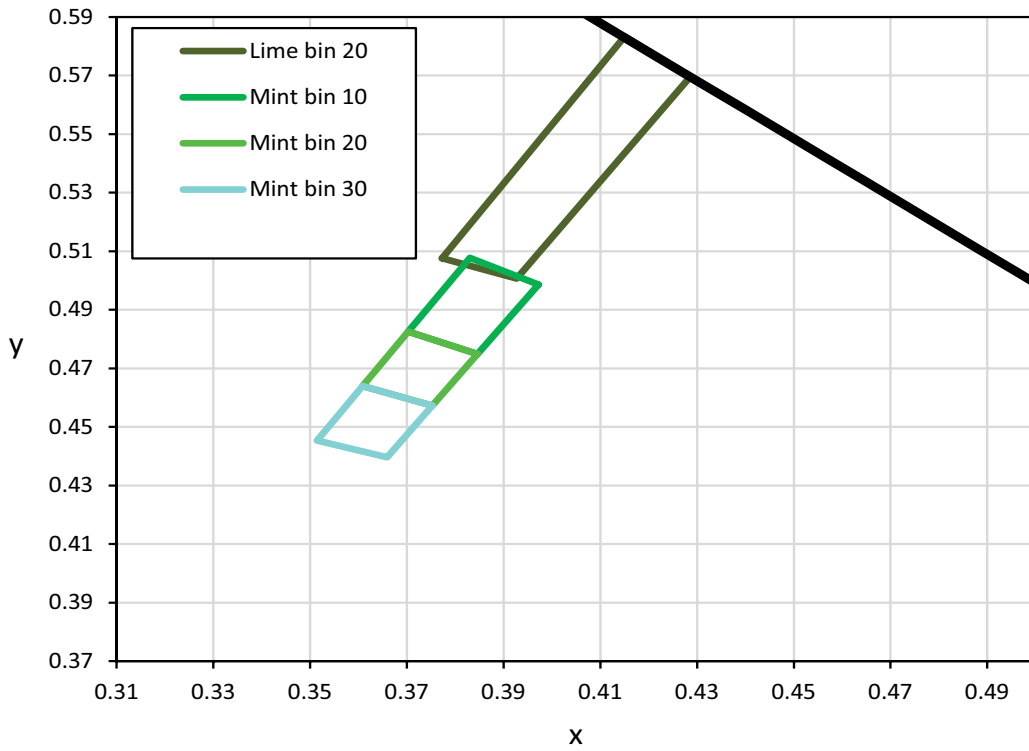

Figure 9. Color Bin Structure for LUXEON 2835 Lime and Mint for Table 7.

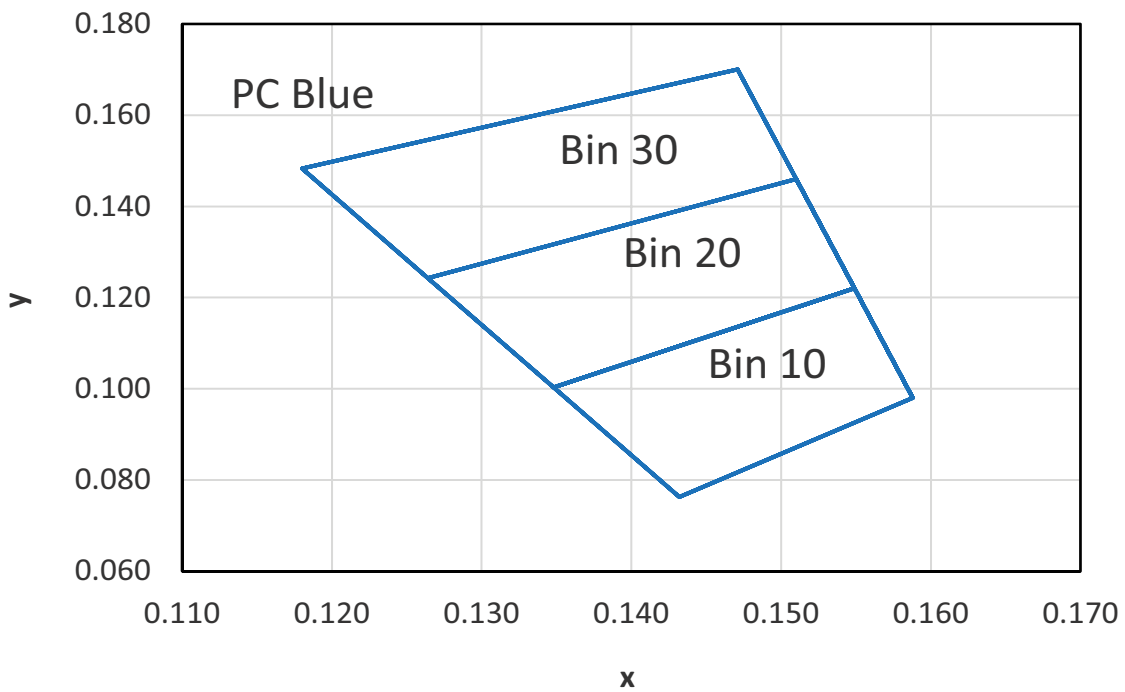

Figure 10. Color Bin Structure for LUXEON 2835 PC Blue for Table 7.

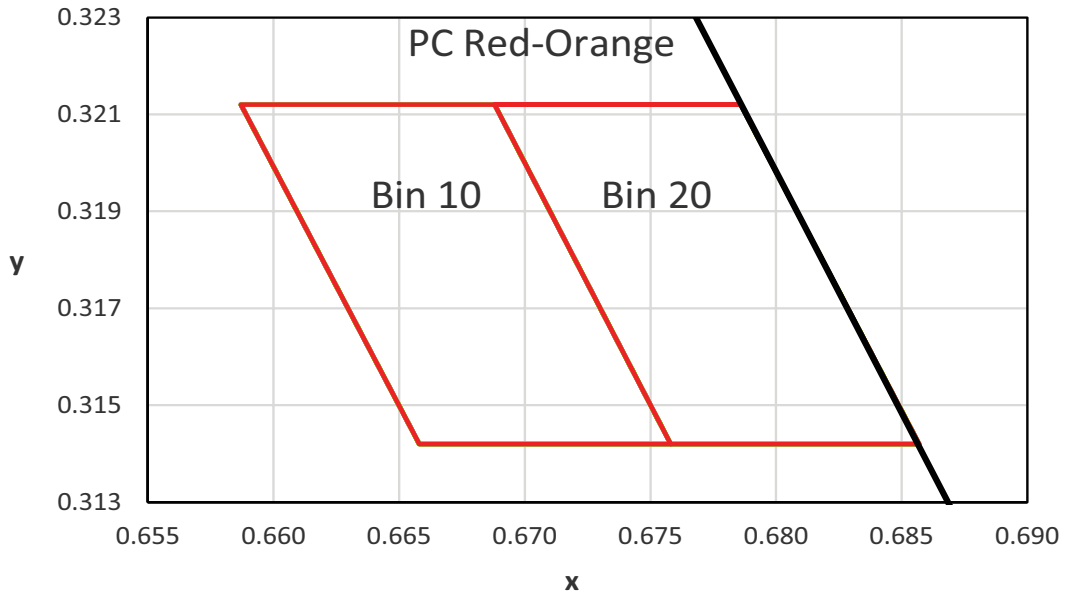

Figure 11. Color Bin Structure for LUXEON 2835 Color 36V PC Red-Orange for Table 8.

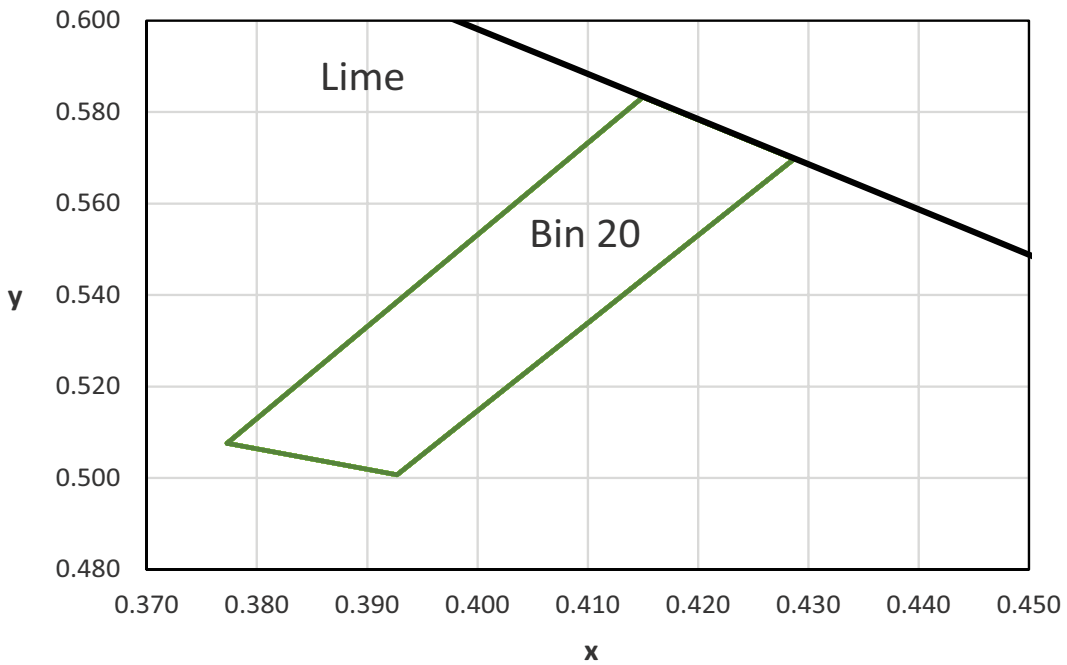

Figure 12. Color Bin Structure for LUXEON 2835 Color 36V Lime for Table 8.

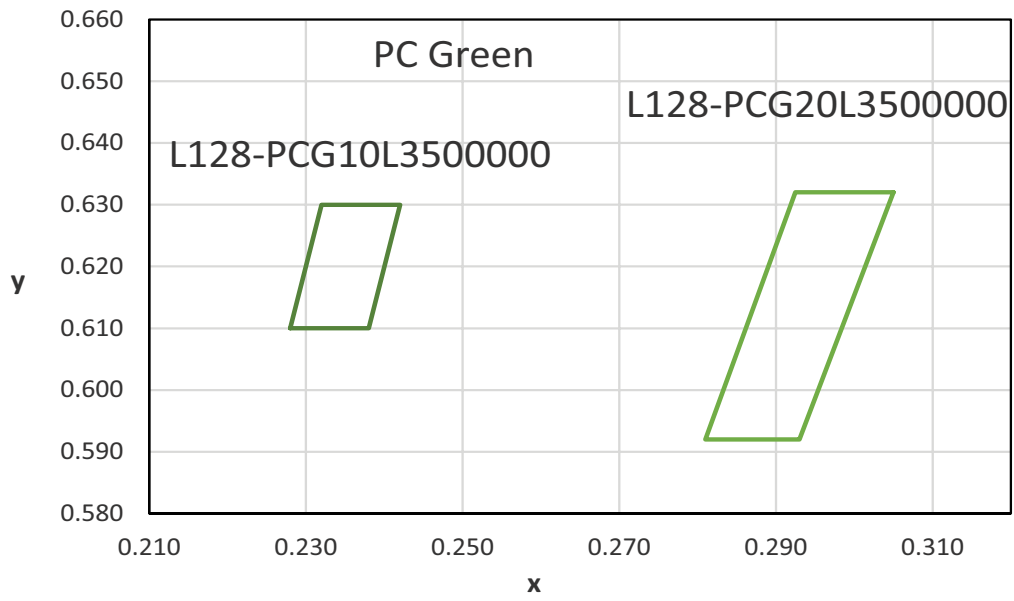

Figure 13. Color Bin Structure for LUXEON 2835 Color 36V PC Green for Table 8.

Table 7. Color bin definitions for LUXEON 2835 PC Red-Orange, PC Amber, Mint, Lime and PC Blue.

COLOR	PART NUMBER	BIN	x	y
PC Red-Orange	L128-PCO1003500000	10	0.6580	0.3320
			0.6479	0.3320
			0.6550	0.3250
			0.6650	0.3250
		20	0.6678	0.3320
			0.6580	0.3320
			0.6650	0.3250
			0.6749	0.3250
PC Amber	L128-PCA1003500000	10	0.5622	0.4372
			0.5843	0.4152
			0.5705	0.4111
			0.5499	0.4249
Mint	L128-MNT1003500000	10	0.3927	0.4986
			0.3830	0.5077
			0.3703	0.4825
			0.3846	0.4749
		20	0.3846	0.4749
			0.3703	0.4825
			0.3608	0.4639
			0.3752	0.4572
		30	0.3752	0.4572
			0.3608	0.4639
			0.3515	0.4453
			0.3659	0.4396
Lime	L128-LME1003500000	20	0.3773	0.5076
			0.3927	0.5007
			0.4287	0.5697
			0.4150	0.5833
PC Blue	L128-PCB1003500000	10	0.1588	0.0980
			0.1549	0.1220
			0.1348	0.1003
			0.1432	0.0763
		20	0.1549	0.1220
			0.1510	0.1460
			0.1264	0.1243
			0.1348	0.1003
		30	0.1510	0.1460
			0.1471	0.1700
			0.1180	0.1483
			0.1264	0.1243

Notes for Table 7:

1. Lumileds maintains a tolerance of ± 0.01 on x and y coordinates in the CIE 1931 color space.

Table 8. Color bin definitions for LUXEON 2835 Color 36V PC Red-Orange, Lime and PC Green.

COLOR	PART NUMBER	BIN	x	y
PC Red-Orange	L128-PCO10L3500000	10	0.6688	0.3212
			0.6587	0.3212
			0.6658	0.3142
			0.6758	0.3142
		20	0.6786	0.3212
			0.6688	0.3212
			0.6758	0.3142
			0.6857	0.3142
Lime	L128-LME10L3500000	20	0.3773	0.5076
			0.3927	0.5007
			0.4287	0.5697
			0.415	0.5833
PC Green	L128-PCG10L3500000	20	0.2280	0.6100
			0.2380	0.6100
			0.2420	0.6300
			0.2320	0.6300
	L128-PCG20L3500000	20	0.3050	0.6320
			0.2925	0.6320
			0.2810	0.5920
			0.2930	0.5920

Notes for Table 8:

1. Lumileds maintains a tolerance of ± 0.01 on x and y coordinates in the CIE 1931 color space.

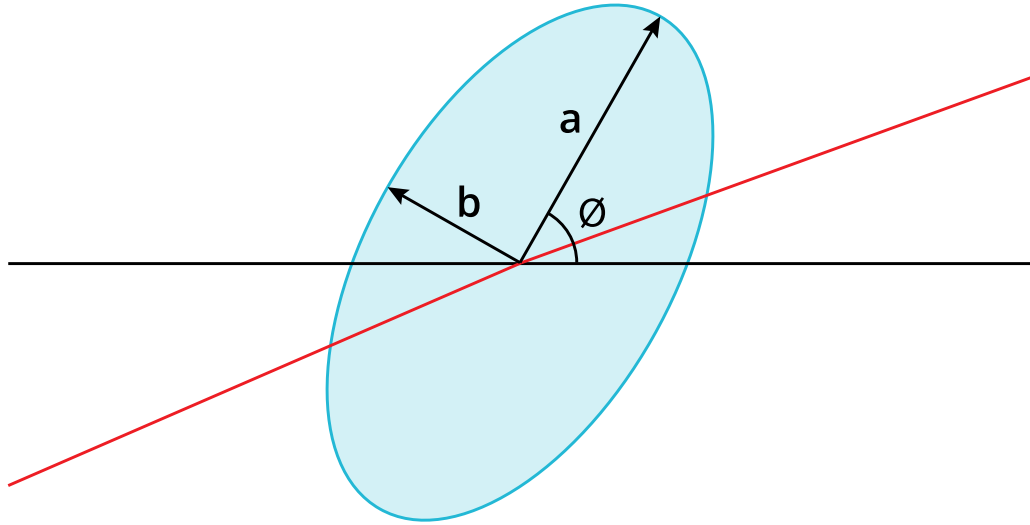

Figure 14. 3- and 5-step MacAdam ellipse illustration for Tables 9a-9c.

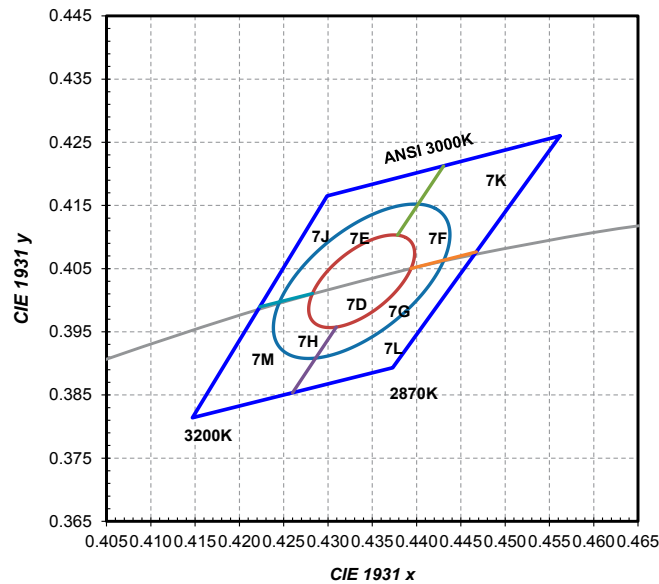

Figure 15a. 1/9th color bin structure for LUXEON 2835 White 3000K at test current and binning temperature of $T_j=25^\circ\text{C}$.

Table 9a. 3- and 5-step MacAdam ellipse color bin definitions for LUXEON 2835E and LUXEON 2835C 3000K, at test and binning conditions.

NOMINAL CCT	COLOR SPACE	CENTER POINT ⁽¹⁾ (cx, cy)	MAJOR AXIS, a	MINOR AXIS, b	ELLIPSE ROTATION ANGLE, Θ
3000K	Single 3-step MacAdam ellipse	(0.4338, 0.4030)	0.00834	0.00408	53.22°
3000K	Single 5-step MacAdam ellipse	(0.4338, 0.4030)	0.01390	0.00680	53.22°

Notes for Table 9a:

1. Lumileds maintains a tolerance of ± 0.007 on x and y color coordinates in the CIE 1931 color space.

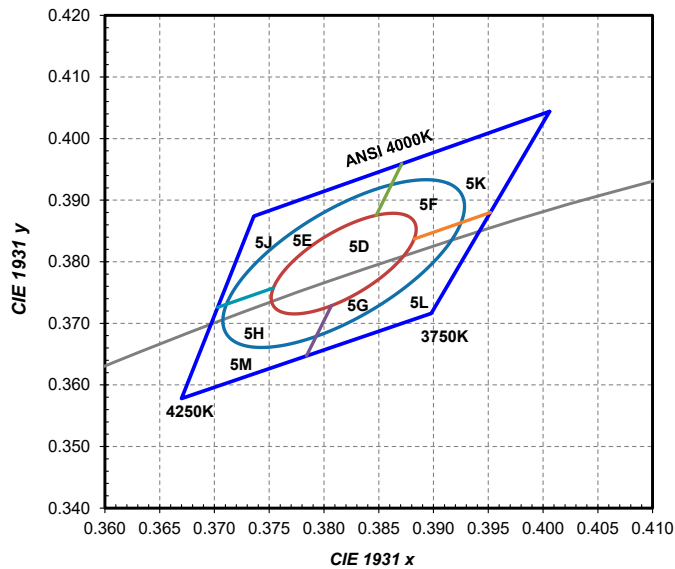

Figure 15b. 1/9th color bin structure for LUXEON 2835E and LUXEON 2835C 4000K at test current and binning temperature of $T_j=25^{\circ}\text{C}$.

Table 9b. 3- and 5-step MacAdam ellipse color bin definitions for LUXEON 2835E and LUXEON 2835C 4000K, at test and binning conditions.

NOMINAL CCT	COLOR SPACE	CENTER POINT ^[1] (cx, cy)	MAJOR AXIS, a	MINOR AXIS, b	ELLIPSE ROTATION ANGLE, θ
4000K	Single 3-step MacAdam ellipse	(0.3818, 0.3797)	0.00939	0.00402	53.72°
4000K	Single 5-step MacAdam ellipse	(0.3818, 0.3797)	0.01565	0.00670	53.72°

Notes for Table 9b:

1. Lumileds maintains a tolerance of ± 0.007 on x and y color coordinates in the CIE 1931 color space.

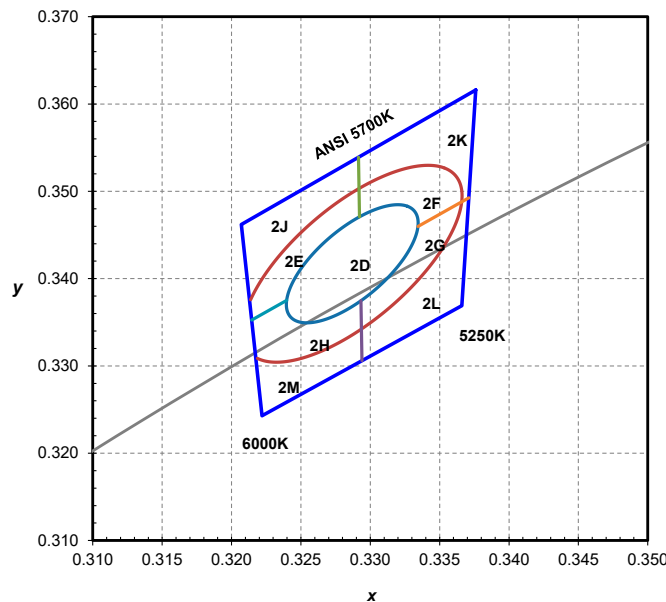

Figure 15c. 1/9th color bin structure for LUXEON 2835E and LUXEON 2835C 5700K at test current and binning temperature of $T_j=25^{\circ}\text{C}$.

Table 9c. 3- and 5-step MacAdam ellipse color bin definitions for LUXEON 2835E and LUXEON 2835C 5700K, at test and binning conditions.

NOMINAL CCT	COLOR SPACE	CENTER POINT ^[1] (cx, cy)	MAJOR AXIS, a	MINOR AXIS, b	ELLIPSE ROTATION ANGLE, θ
5700K	Single 3-step MacAdam ellipse	(0.3287, 0.3417)	0.00746	0.00320	59.09°
5700K	Single 5-step MacAdam ellipse	(0.3287, 0.3417)	0.01243	0.00533	59.09°

Notes for Table 9c:

1. Lumileds maintains a tolerance of ± 0.007 on x and y color coordinates in the CIE 1931 color space.

Peak Wavelength Bins

Table 10a. Peak wavelength bin definitions for LUXEON 2835 Far Red, Deep Red and Royal Blue.

COLOR	PART NUMBER	BIN	PEAK WAVELENGTH ⁽¹⁾ (nm)	
			MINIMUM	MAXIMUM
Far Red	L128-FRD1003500000	10	720	740
Deep Red	L128-DRD1003500000	10	650	670
Royal Blue	L128-RYL1003500000	30	440	445
		40	445	450
		50	450	455

Notes for Table 10a:

1. Lumileds maintains a tolerance of ± 0.5 nm on peak wavelength measurements.

Table 10b. Peak wavelength bin definitions for LUXEON 2835 Color 36V Royal Blue.

COLOR	PART NUMBER	BIN	PEAK WAVELENGTH ⁽¹⁾ (nm)	
			MINIMUM	MAXIMUM
Royal Blue	L128-RYL1003500000	30	440	445
		40	445	450
		50	450	455

Notes for Table 10b:

1. Lumileds maintains a tolerance of ± 0.5 nm on peak wavelength measurements.

Dominant Wavelength Bins

Table 11. Dominant wavelength bin definitions for LUXEON 2835 Red, Red-Orange, Green, Cyan and Blue.

COLOR	PART NUMBER	BIN	DOMINANT WAVELENGTH ⁽¹⁾ (nm)	
			MINIMUM	MAXIMUM
Red	L128-RED1003500000	40	620	630
Red-Orange	L128-RNG1003500000	20	610	620
Green	L128-GRN1003500000	10	520	525
		20	525	530
		30	530	535
		40	535	540
Cyan	L128-CYN1003500000	10	490	495
		20	495	500
		30	500	505
		40	505	510
Blue	L128-BLU1003500000	20	469	475
		30	475	480

Notes for Table 11:

1. Lumileds maintains a tolerance of ± 1 nm on dominant wavelength measurements.

Forward Voltage Bins

Table 12a. Forward voltage bin definitions for LUXEON 2835 Far Red, Deep Red, Red and Red-Orange.

BIN	FORWARD VOLTAGE ⁽¹⁾ (V _f)	
	MINIMUM	MAXIMUM
B	1.80	2.00
C	2.00	2.20
D	2.20	2.40
E	2.40	2.60

Table 12b. Forward voltage bin definitions for LUXEON 2835 PC Red-Orange, PC Amber, Mint, Lime, Green, Cyan, Blue, Royal Blue and White.

BIN	FORWARD VOLTAGE ⁽¹⁾ (V _f)	
	MINIMUM	MAXIMUM
Z	2.70	2.80
A	2.80	2.90
B	2.90	3.00
C	3.00	3.10
D	3.10	3.20
E	3.20	3.30

Table 12c. Forward voltage bin definitions for LUXEON 2835 Color 36V.

BIN	FORWARD VOLTAGE ⁽¹⁾ (V _f)	
	MINIMUM	MAXIMUM
A	35.0	35.5
B	35.5	36.0
C	36.0	36.5
D	36.5	37.0
E	37.0	37.5

Notes for Tables 12a, 12b and 12c:

1. Lumileds maintains a tolerance of $\pm 0.1V$ on forward voltage measurements.

Mechanical Dimensions

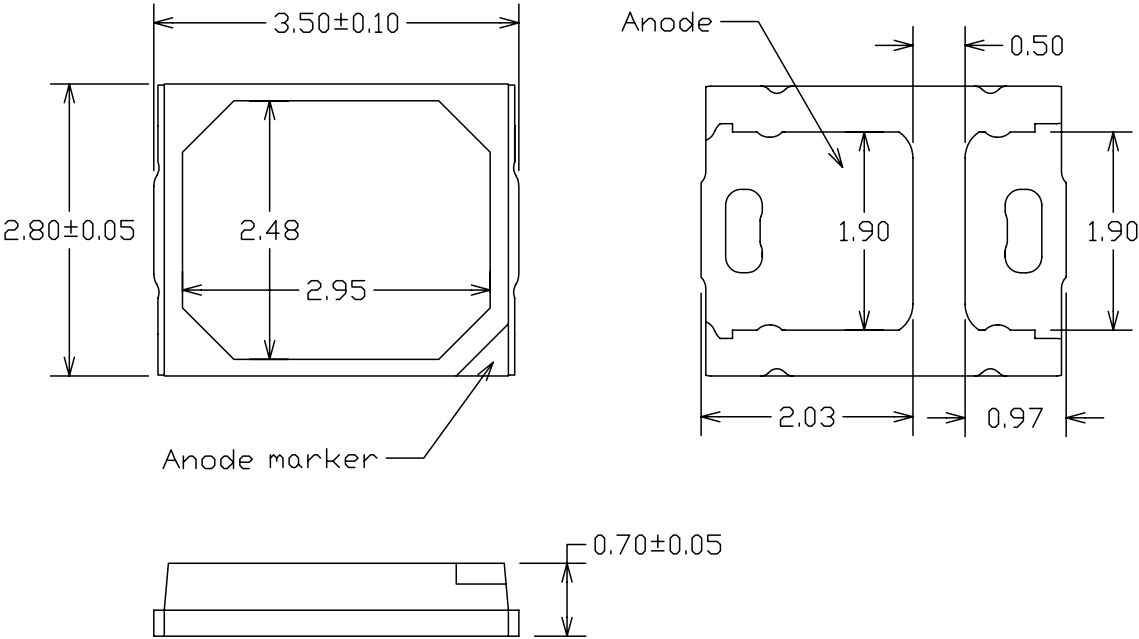

Figure 16. Mechanical dimensions for LUXEON 2835 Color Line.

- Notes for Figure 16:
- 1. Drawings are not to scale.
 - 2. All dimensions are in millimeters.
 - 3. Tolerance of ± 0.1 mm.

Reflow Soldering Guidelines

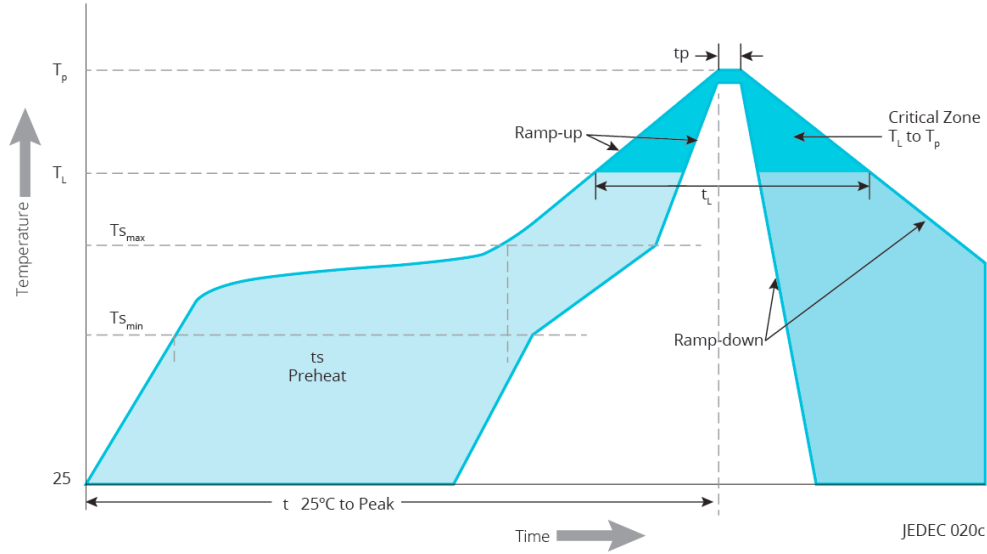

Figure 17. Visualization of the acceptable reflow temperature profile as specified in Table 12.

Table 13. Reflow profile characteristics for LUXEON 2835 Color Line.

PROFILE FEATURE	LEAD-FREE ASSEMBLY
Preheat Minimum Temperature (T_{smin})	150°C
Preheat Maximum Temperature (T_{smax})	200°C
Preheat Time (t_{smin} to t_{smax})	60 to 120 seconds
Ramp-Up Rate (T_L to T_p)	3°C / second maximum
Liquidus Temperature (T_L)	217°C
Time Maintained Above Temperature T_L (t_L)	60 to 150 seconds
Peak / Classification Temperature (T_p)	260°C
Time Within 5°C of Actual Temperature (t_p)	20 to 40 seconds
Ramp-Down Rate (T_p to T_L)	6°C / second maximum
Time 25°C to Peak Temperature	8 minutes maximum

JEDEC Moisture Sensitivity

Table 14. Moisture sensitivity levels for LUXEON 2835 Color Line.

LEVEL	FLOOR LIFE		SOAK REQUIREMENTS STANDARD	
	TIME	CONDITIONS	TIME	CONDITIONS
3	168 Hours	≤30°C / 60% RH	192 Hours +5 / -0	30°C / 60% RH

Solder Pad Design

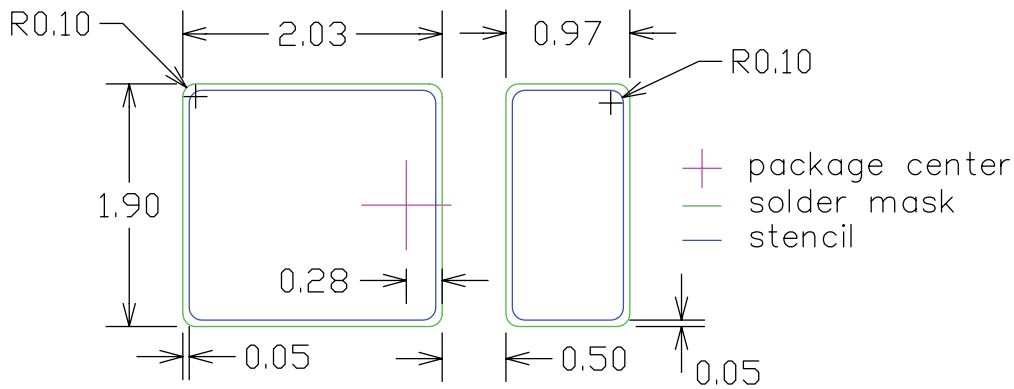

Figure 18. Recommended PCB solder pad layout for LUXEON 2835 Color Line.

Notes for Figure 18:

1. Drawings are not to scale.
2. All dimensions are in millimeters.

Packaging Information

Pocket Tape Dimensions

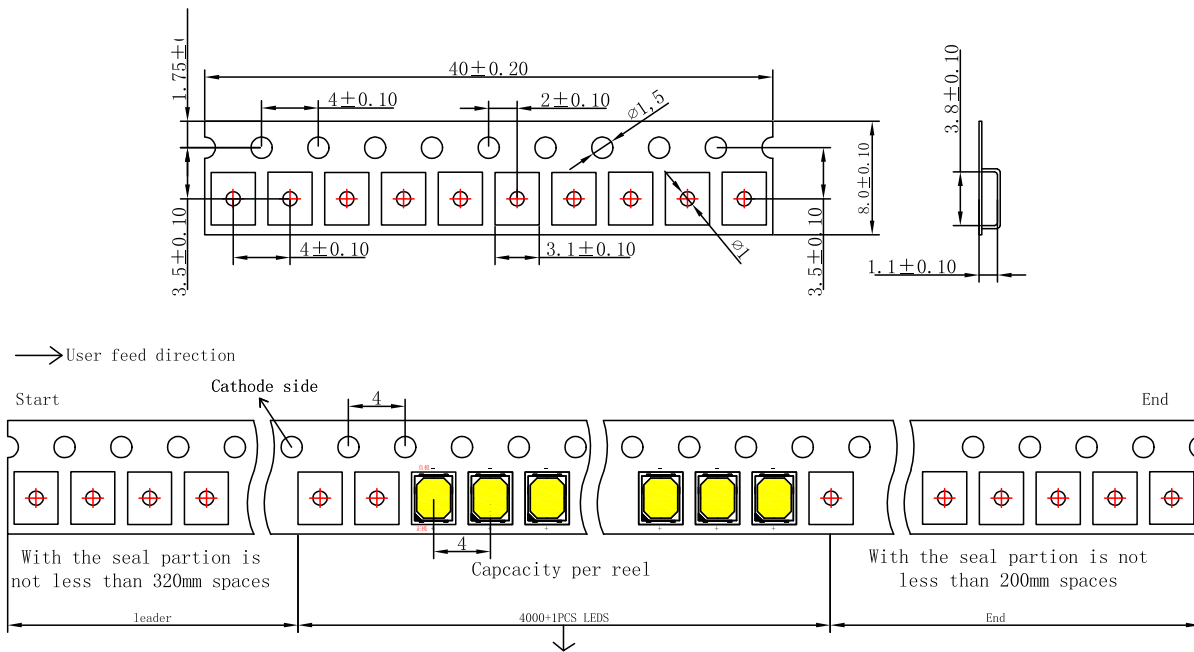

Figure 19. Pocket Tape dimensions for LUXEON 2835 Color Line.

Notes for Figure 19:

1. Drawings are not to scale.
2. All dimensions are in millimeters.
3. Empty components pockets sealed with top cover tape.

Reel Dimensions

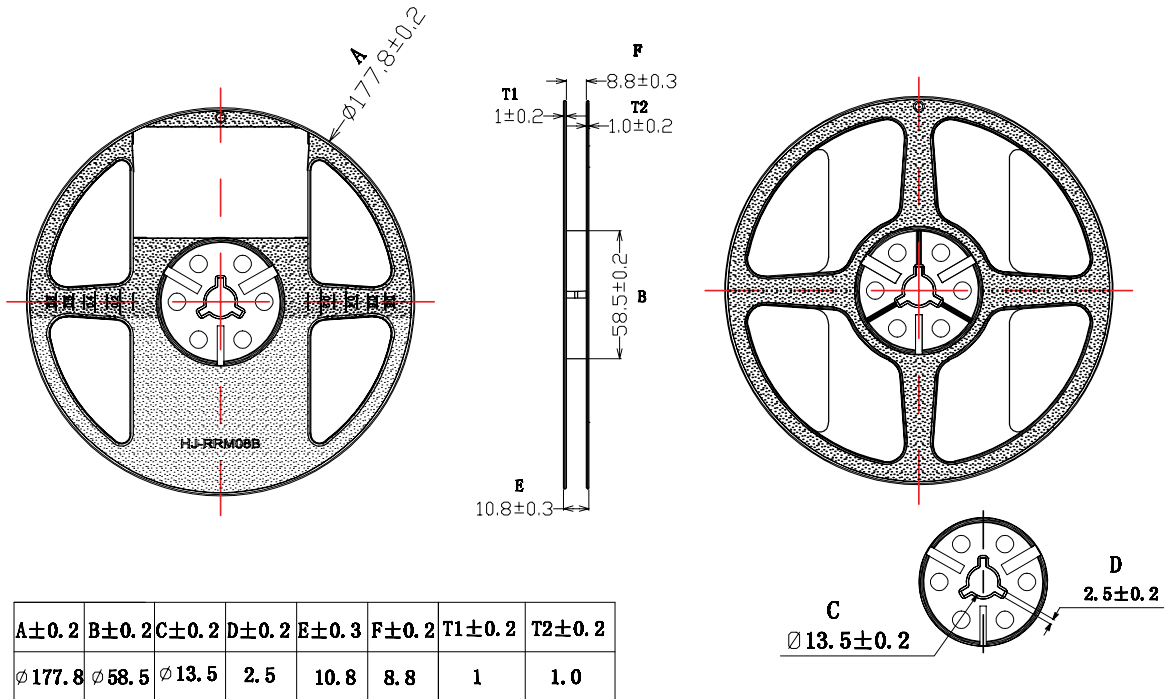

Figure 20. Reel dimensions for LUXEON 2835 Color Line.

Notes for Figure 20:

1. Dra1 wings are not to scale.
2. All dimensions are in millimeters.
3. Empty component pockets sealed with top cover tape.
4. 329mm reel — 4,000 pieces per reel.
5. Minimum packing quantity is 4,000 pieces.
6. The maximum number of consecutive missing LEDs is two.
7. In accordance with EIA-481-1-B specification.

About Lumileds

Companies developing automotive, mobile, IoT and illumination lighting applications need a partner who can collaborate with them to push the boundaries of light. With over 100 years of inventions and industry firsts, Lumileds is a global lighting solutions company that helps customers around the world deliver differentiated solutions to gain and maintain a competitive edge. As the inventor of Xenon technology, a pioneer in halogen lighting and the leader in high performance LEDs, Lumileds builds innovation, quality and reliability into its technology, products and every customer engagement. Together with its customers, Lumileds is making the world better, safer, more beautiful—with light.

To learn more about our lighting solutions, visit lumileds.com.



©2022 Lumileds Holding B.V. All rights reserved.
LUXEON is a registered trademark of the Lumileds Holding B.V. in the United States and other countries.

lumileds.com

Neither Lumileds Holding B.V. nor its affiliates shall be liable for any kind of loss of data or any other damages, direct, indirect or consequential, resulting from the use of the provided information and data. Although Lumileds Holding B.V. and/or its affiliates have attempted to provide the most accurate information and data, the materials and services information and data are provided "as is," and neither Lumileds Holding B.V. nor its affiliates warrants or guarantees the contents and correctness of the provided information and data. Lumileds Holding B.V. and its affiliates reserve the right to make changes without notice. You as user agree to this disclaimer and user agreement with the download or use of the provided materials, information and data. A listing of Lumileds product/patent coverage may be accessed at lumileds.com/patents.

DS236 LLUXEON 2835 Color Line
Product Datasheet 20220926