

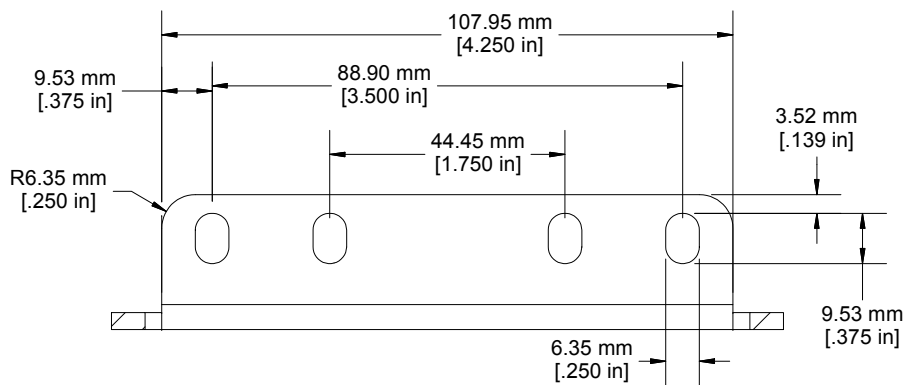

SECTION B-B

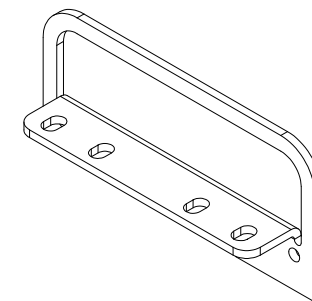

SECTION A-A

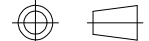

DWN		 <b>HAMMOND MANUFACTURING CO. LTD.</b> 485 Conestogo Road Waterloo, Ontario, N2L 4C9, Canada
DATE		
CHK		
MAT'L		
SHEET		THIS DRAWING IS PROPRIETARY INFORMATION OF HAMMOND MFG. CO. LTD. NOT TO BE USED WITHOUT EXPRESSED WRITTEN PERMISSION OF HAMMOND MFG. CO. LTD.
		<b>RMCHANDLE3U</b>