

Automotive P-Channel 30 V (D-S) 175 °C MOSFET

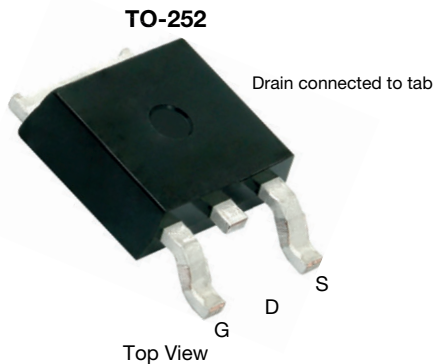

FEATURES

- TrenchFET® power MOSFET
- Package with low thermal resistance
- 100 % R_g and UIS tested
- AEC-Q101 qualified
- Material categorization:
for definitions of compliance please see
www.vishay.com/doc?99912

 AUTOMOTIVE
GRADE

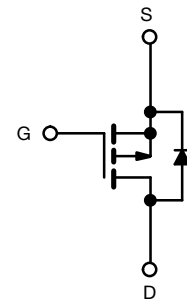
RoHS
COMPLIANT
HALOGEN
FREE

P-Channel MOSFET

PRODUCT SUMMARY

V _{DS} (V)	-30
R _{DS(on)} (Ω) at V _{GS} = -10 V	0.00320
R _{DS(on)} (Ω) at V _{GS} = -4.5 V	0.00520
I _D (A)	-100
Configuration	Single
Package	TO-252

ABSOLUTE MAXIMUM RATINGS (T_C = 25 °C, unless otherwise noted)

PARAMETER	SYMBOL	LIMIT	UNIT
Drain-source voltage	V _{DS}	-30	V
Gate-source voltage	V _{GS}	± 20	
Continuous drain current	I _D	T _C = 25 °C ^a	-100
		T _C = 125 °C	-94
Continuous source current (diode conduction) ^a	I _S	-100	A
Pulsed drain current ^b	I _{DM}	-300	
Single pulse avalanche current	I _{AS}	-41	
Single pulse avalanche energy	E _{AS}	84	mJ
Maximum power dissipation ^b	P _D	T _C = 25 °C	136
		T _C = 125 °C	45
Operating junction and storage temperature range	T _J , T _{stg}	-55 to +175	°C

THERMAL RESISTANCE RATINGS

PARAMETER	SYMBOL	LIMIT	UNIT
Junction-to-ambient	R _{thJA}	50	°C/W
Junction-to-case (drain)	R _{thJC}	1.1	

Notes

- Package limited
- Pulse test; pulse width ≤ 300 μs, duty cycle ≤ 2 %
- When mounted on 1" square PCB (FR4 material)



SPECIFICATIONS (T _C = 25 °C, unless otherwise noted)						
PARAMETER	SYMBOL	TEST CONDITIONS	MIN.	TYP.	MAX.	UNIT
Static						
Drain-source breakdown voltage	V _{DS}	V _{GS} = 0 V, I _D = -250 μA	-30	-	-	V
Gate-source threshold voltage	V _{GS(th)}	V _{DS} = V _{GS} , I _D = -250 μA	-1.5	-2.0	-2.5	
Gate-source leakage	I _{GSS}	V _{DS} = 0 V, V _{GS} = ± 20 V	-	-	± 100	nA
Zero gate voltage drain current	I _{DSS}	V _{GS} = 0 V, V _{DS} = -30 V	-	-	-1	μA
		V _{GS} = 0 V, V _{DS} = -30 V, T _J = 125 °C	-	-	-50	
		V _{GS} = 0 V, V _{DS} = -30 V, T _J = 175 °C	-	-	-250	
On-state drain current ^a	I _{D(on)}	V _{GS} = -10 V, V _{DS} ≥ -5 V	-50	-	-	A
Drain-source on-state resistance ^a	R _{DS(on)}	V _{GS} = -10 V, I _D = -30 A	-	0.00263	0.00320	Ω
		V _{GS} = -10 V, I _D = -30 A, T _J = 125 °C	-	-	0.00438	
		V _{GS} = -10 V, I _D = -30 A, T _J = 175 °C	-	-	0.00502	
		V _{GS} = -4.5 V, I _D = -25 A	-	0.00425	0.00520	
Forward transconductance ^b	g _{fs}	V _{DS} = -15 V, I _D = 30 A	-	98	-	S
Dynamic ^b						
Input capacitance	C _{iss}	V _{GS} = 0 V, V _{DS} = -25 V, f = 1 MHz	-	11 085	15 000	pF
Output capacitance	C _{oss}		-	1342	1900	
Reverse transfer capacitance	C _{rss}		-	1181	1600	
Total Gate Charge ^c	Q _g	V _{GS} = -10 V, V _{DS} = -15 V, I _D = -100 A	-	186	280	nC
Gate-source charge ^c	Q _{gs}		-	28	-	
Gate-drain charge ^c	Q _{gd}		-	28	-	
Gate resistance	R _g	f = 1 MHz	1.7	3.5	5.3	Ω
Turn-on delay time ^c	t _{d(on)}	V _{DD} = -15 V, R _L = 0.2 Ω I _D ≅ -100 A, V _{GEN} = -10 V, R _g = 1 Ω	-	16	25	ns
Rise time ^c	t _r		-	204	310	
Turn-off delay time ^c	t _{d(off)}		-	126	190	
Fall time ^c	t _f		-	72	110	
Source-Drain Diode Ratings and Characteristics ^b						
Pulsed current ^a	I _{SM}		-	-	-300	A
Forward voltage	V _{SD}	I _F = -30 A, V _{GS} = 0 V	-	-0.8	-1.5	V
Body diode reverse recovery time	t _{rr}	I _F = -40 A, di/dt = 100 A/μs	-	66	135	ns
Body diode reverse recovery charge	Q _{rr}		-	100	200	nC
Reverse recovery fall time	t _a		-	31	-	ns
Reverse recovery rise time	t _b		-	35	-	
Body diode peak reverse recovery current	I _{RM(REC)}			-	-3.4	-

Notes

- Pulse test; pulse width ≤ 300 μs, duty cycle ≤ 2 %
- Guaranteed by design, not subject to production testing
- Independent of operating temperature

Stresses beyond those listed under "Absolute Maximum Ratings" may cause permanent damage to the device. These are stress ratings only, and functional operation of the device at these or any other conditions beyond those indicated in the operational sections of the specifications is not implied. Exposure to absolute maximum rating conditions for extended periods may affect device reliability.

TYPICAL CHARACTERISTICS ($T_A = 25\text{ }^\circ\text{C}$, unless otherwise noted)

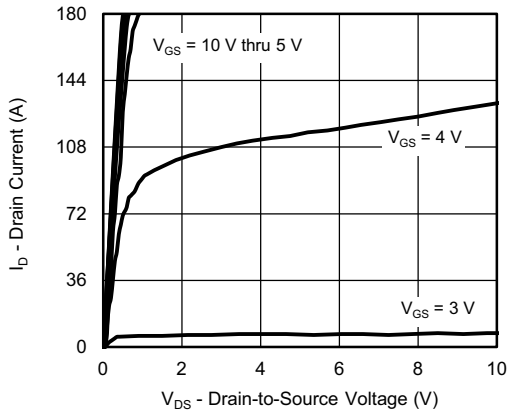

Output Characteristics

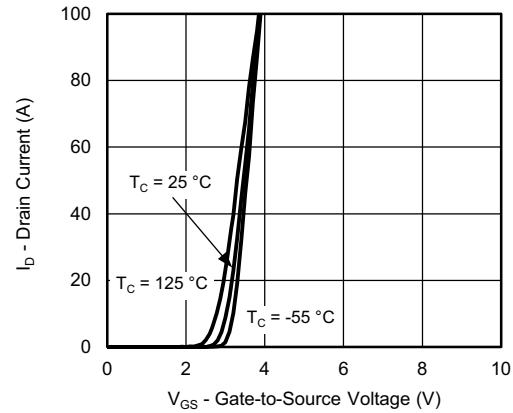

Transfer Characteristics

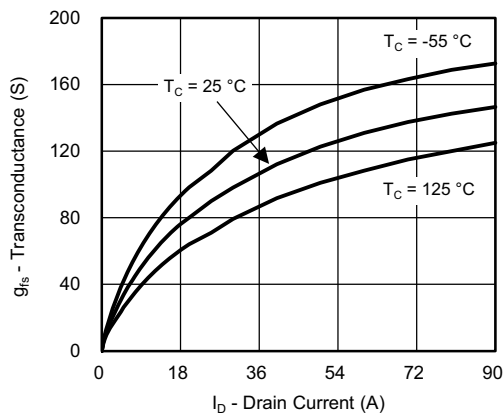

Transconductance

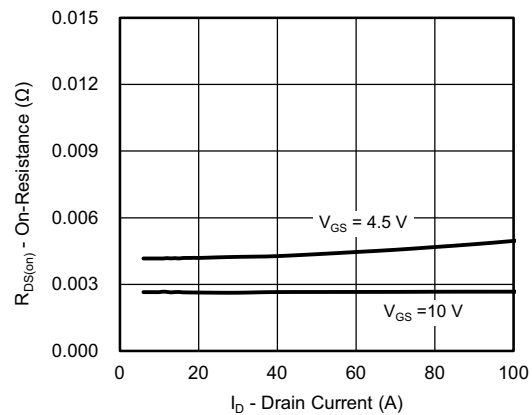

On-Resistance vs. Drain Current

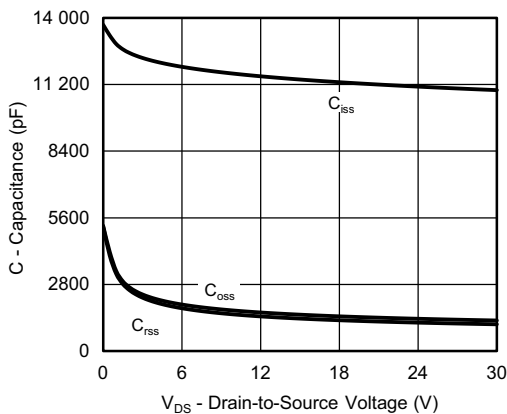

Capacitance

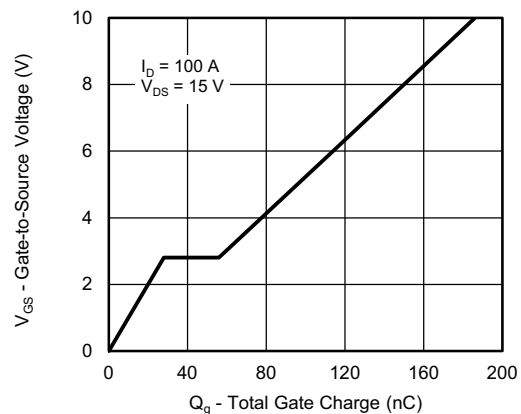

Gate Charge

TYPICAL CHARACTERISTICS ($T_A = 25\text{ }^\circ\text{C}$, unless otherwise noted)

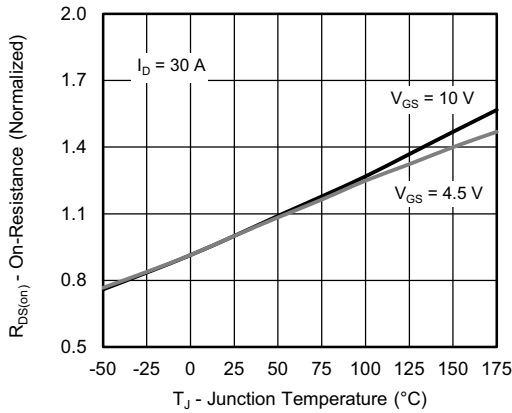

On-Resistance vs. Junction Temperature

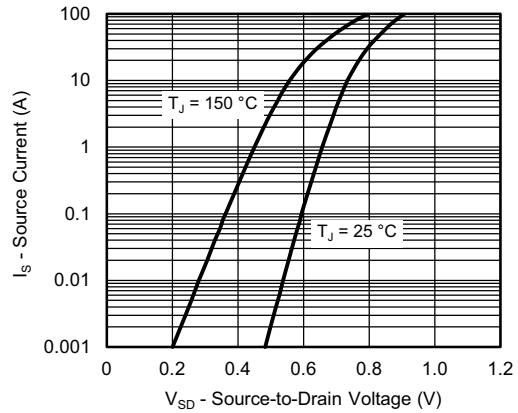

Source Drain Diode Forward Voltage

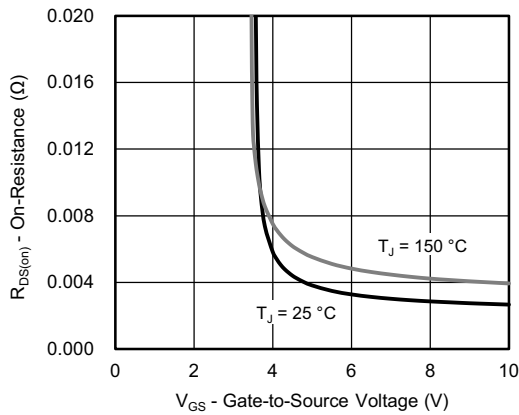

On-Resistance vs. Gate-to-Source Voltage

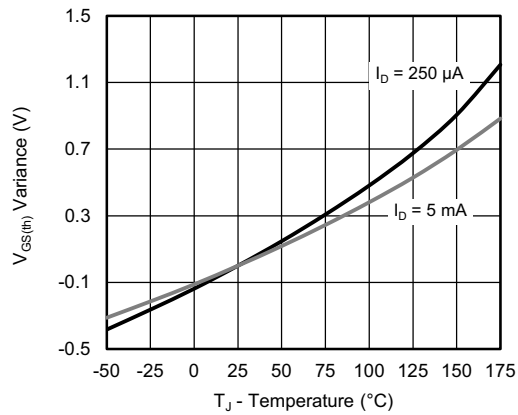

Threshold Voltage

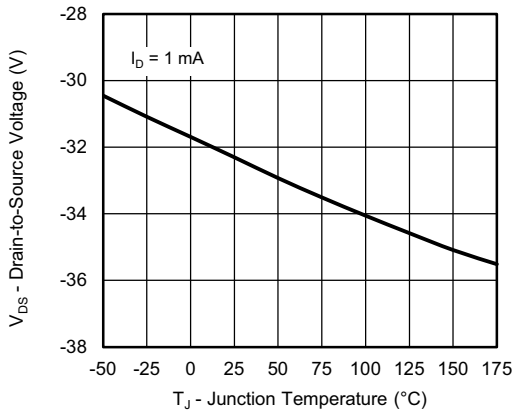

Drain Source Breakdown vs. Junction Temperature

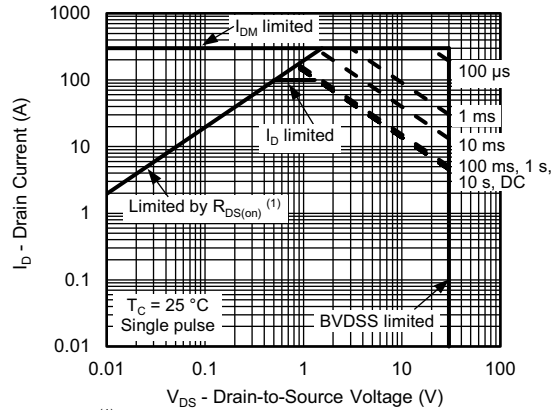

⁽¹⁾ $V_{GS} >$ minimum V_{GS} at which $R_{DS(on)}$ is specified

Safe Operating Area



THERMAL RATINGS ($T_A = 25\text{ }^\circ\text{C}$, unless otherwise noted)

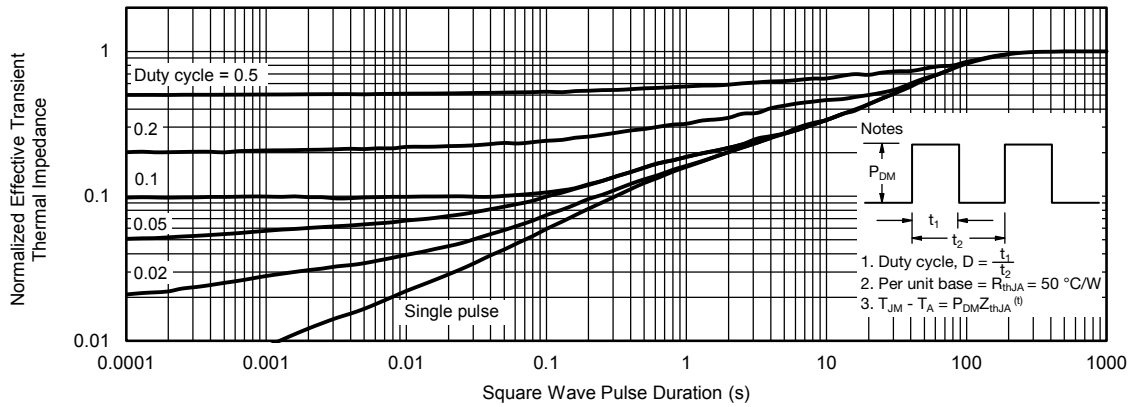

Normalized Thermal Transient Impedance, Junction-to-Ambient

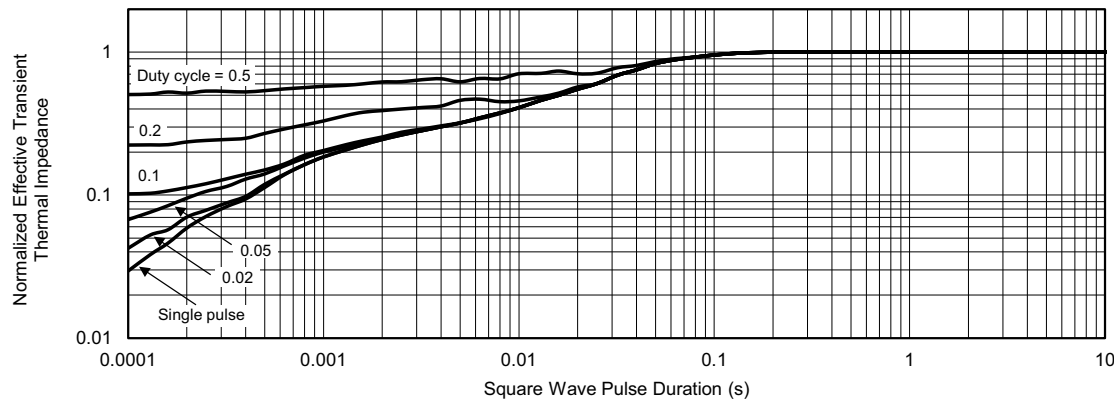

Normalized Thermal Transient Impedance, Junction-to-Case

Note

- The characteristics shown in the two graphs
 - Normalized Transient Thermal Impedance Junction-to- Ambient ($25\text{ }^\circ\text{C}$)
 - Normalized Transient Thermal Impedance Junction-to-Case ($25\text{ }^\circ\text{C}$)
- are given for general guidelines only to enable the user to get a “ball park” indication of part capabilities. The data are extracted from single pulse transient thermal impedance characteristics which are developed from empirical measurements. The latter is valid for the part mounted on printed circuit board - FR4, size 1" x 1" x 0.062", double sided with 2 oz. copper, 100 % on both sides. The part capabilities can widely vary depending on actual application parameters and operating conditions

Vishay Siliconix maintains worldwide manufacturing capability. Products may be manufactured at one of several qualified locations. Reliability data for Silicon Technology and Package Reliability represent a composite of all qualified locations. For related documents such as package / tape drawings, part marking, and reliability data, see www.vishay.com/ppg?76011.

TO-252AA Case Outline

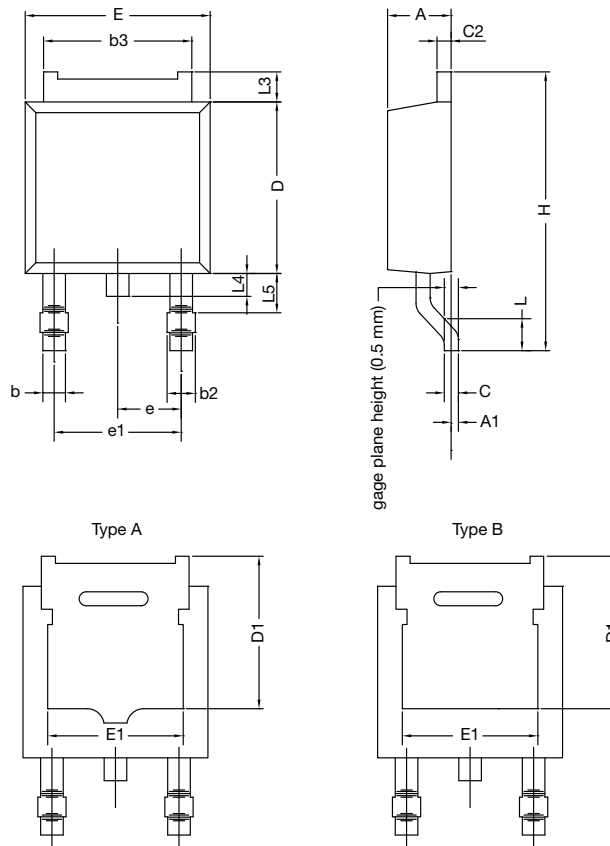

DIM.	MILLIMETERS		INCHES	
	MIN.	MAX.	MIN.	MAX.
A	2.18	2.38	0.086	0.094
A1	-	0.127	-	0.005
b	0.64	0.88	0.025	0.035
b2	0.76	1.14	0.030	0.045
b3	4.95	5.46	0.195	0.215
C	0.46	0.61	0.018	0.024
C2	0.46	0.89	0.018	0.035
D	5.97	6.22	0.235	0.245
D1	4.10	-	0.161	-
E	6.35	6.73	0.250	0.265
E1	4.32	-	0.170	-
H	9.40	10.41	0.370	0.410
e	2.28 BSC		0.090 BSC	
e1	4.56 BSC		0.180 BSC	
L	1.40	1.78	0.055	0.070
L3	0.89	1.27	0.035	0.050
L4	-	1.02	-	0.040
L5	1.01	1.52	0.040	0.060

ECN: T24-0298-Rev. B, 29-Jul-2024
DWG: 6019

Notes

- Dimension L3 is for reference only
- Dimension D1 and E1 on type A and B is the same

RECOMMENDED MINIMUM PADS FOR DPAK (TO-252)

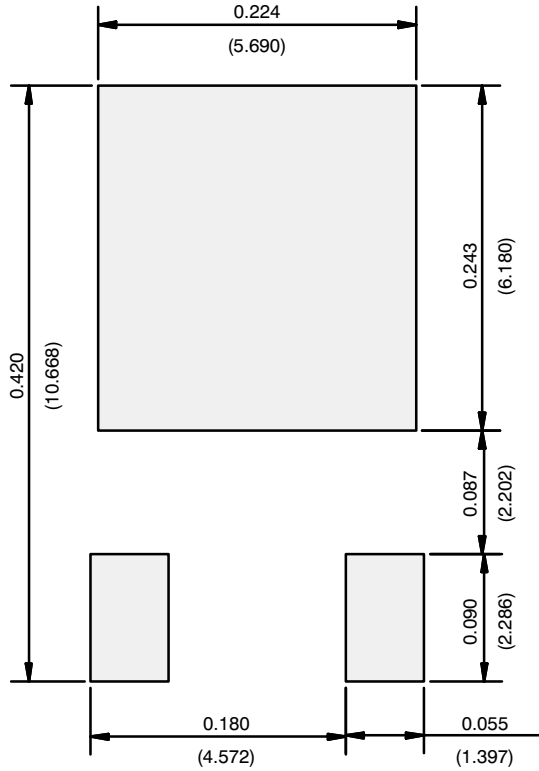

Recommended Minimum Pads
Dimensions in Inches/(mm)

[Return to Index](#)



Disclaimer

ALL PRODUCT, PRODUCT SPECIFICATIONS AND DATA ARE SUBJECT TO CHANGE WITHOUT NOTICE TO IMPROVE RELIABILITY, FUNCTION OR DESIGN OR OTHERWISE.

Vishay Intertechnology, Inc., its affiliates, agents, and employees, and all persons acting on its or their behalf (collectively, "Vishay"), disclaim any and all liability for any errors, inaccuracies or incompleteness contained in any datasheet or in any other disclosure relating to any product.

Vishay makes no warranty, representation or guarantee regarding the suitability of the products for any particular purpose or the continuing production of any product. To the maximum extent permitted by applicable law, Vishay disclaims (i) any and all liability arising out of the application or use of any product, (ii) any and all liability, including without limitation special, consequential or incidental damages, and (iii) any and all implied warranties, including warranties of fitness for particular purpose, non-infringement and merchantability.

Statements regarding the suitability of products for certain types of applications are based on Vishay's knowledge of typical requirements that are often placed on Vishay products in generic applications. Such statements are not binding statements about the suitability of products for a particular application. It is the customer's responsibility to validate that a particular product with the properties described in the product specification is suitable for use in a particular application. Parameters provided in datasheets and / or specifications may vary in different applications and performance may vary over time. All operating parameters, including typical parameters, must be validated for each customer application by the customer's technical experts. Product specifications do not expand or otherwise modify Vishay's terms and conditions of purchase, including but not limited to the warranty expressed therein.

Hyperlinks included in this datasheet may direct users to third-party websites. These links are provided as a convenience and for informational purposes only. Inclusion of these hyperlinks does not constitute an endorsement or an approval by Vishay of any of the products, services or opinions of the corporation, organization or individual associated with the third-party website. Vishay disclaims any and all liability and bears no responsibility for the accuracy, legality or content of the third-party website or for that of subsequent links.

Vishay products are not designed for use in life-saving or life-sustaining applications or any application in which the failure of the Vishay product could result in personal injury or death unless specifically qualified in writing by Vishay. Customers using or selling Vishay products not expressly indicated for use in such applications do so at their own risk. Please contact authorized Vishay personnel to obtain written terms and conditions regarding products designed for such applications.

No license, express or implied, by estoppel or otherwise, to any intellectual property rights is granted by this document or by any conduct of Vishay. Product names and markings noted herein may be trademarks of their respective owners.