

## Power Metal Strip® Shunt Resistor, Low TCR (Down to $< \pm 10 \text{ ppm}/^\circ\text{C}$ ), Very Low Value (Down to $15 \mu\Omega$ )

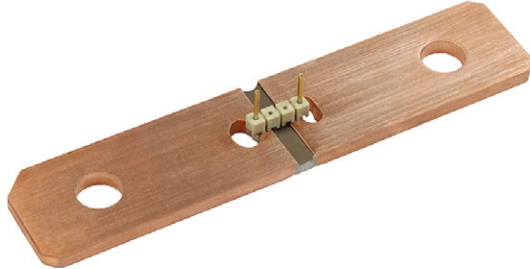

### FEATURES

- High power capability that enables current sensing to 1825 A
- Proprietary processing technique produces extremely low resistance values
- All welded construction
- Solid metal nickel-chrome alloy resistive element with unique design for low TCR (down to  $\pm 10 \text{ ppm}/^\circ\text{C}$ )
- Very low inductance ( $< 5 \text{ nH}$ )
- Low thermal EMF (as low as  $< 1.25 \mu\text{V}/^\circ\text{C}$ )
- AEC-Q200 qualified
- PATENT(S): [www.vishay.com/patents](http://www.vishay.com/patents)
- Material categorization: for definitions of compliance please see [www.vishay.com/doc?99912](http://www.vishay.com/doc?99912)



**RoHS**  
COMPLIANT  
HALOGEN  
**FREE**  
**GREEN**  
(5-2008)

### LINKS TO ADDITIONAL RESOURCES



STANDARD ELECTRICAL SPECIFICATIONS						
GLOBAL MODEL	SIZE	POWER RATING $P_{70^\circ\text{C}}$ W	TOLERANCE $\pm \%$	RESISTANCE VALUE RANGE $\Omega$	RESISTANCE VALUES CURRENTLY AVAILABLE <sup>(1)</sup> $\Omega$	WEIGHT (typical) g
WSBE8518	8518	36	5	30 $\mu$ to 100 $\mu$	50 $\mu$ , 100 $\mu$	36
WSBE8536	8536	50	5	15 $\mu$ to 50 $\mu$	50 $\mu$	72

#### Note

<sup>(1)</sup> Other values may be available, contact factory

TECHNICAL SPECIFICATIONS			
PARAMETER	UNIT	RESISTOR CHARACTERISTICS	
		WSBE8518	WSBE8536
Temperature coefficient	ppm/ $^\circ\text{C}$ (-20 $^\circ\text{C}$ to +150 $^\circ\text{C}$ )	$\pm 10$ for all R-values	$\pm 10$ for all R-values
Operating temperature range <sup>(1)</sup>	$^\circ\text{C}$	-65 to +170	
Thermal EMF	$\mu\text{V}/^\circ\text{C}$	$< 1.25$	
Inductance	nH	$< 5$	
Maximum current rating	A	$(P/R)^{1/2}$	

#### Note

<sup>(1)</sup> Limited temperature range by connector molex® DV and DR -40  $^\circ\text{C}$  to +125  $^\circ\text{C}$

GLOBAL PART NUMBER INFORMATION																	
GLOBAL PART NUMBERING: WSBE8518L1000JTA2 (WSBE8518...A2, 0.0001 $\Omega$ , $\pm 5 \%$ , tray pack)																	
W	S	B	E	8	5	1	8	L	1	0	0	0	J	T	A	2	
GLOBAL MODEL				RESISTANCE VALUE				TOLERANCE CODE		PACKAGING CODE			CONNECTOR AND OPTIONS				
WSBE8518 WSBE8536				L = m $\Omega$ L1000 = 0.0001 $\Omega$				J = $\pm 5 \%$		K = bulk pack T = tray pack			See table				

PATENT(S): [www.vishay.com/patents](http://www.vishay.com/patents)

This Vishay product is protected by one or more United States and international patents.

CONNECTOR AND OPTIONS		
CONNECTOR	NUMBER OF PINS / CODE	PLATING / CODE
A - Samtec® header	2 or 3	Blank = unplated P = tin plated
B - Samtec® shrouded	2 or 3	Blank = unplated P = tin plated
D - molex® Duraclik	V = vertical 7 pins A = vertical 7 pins NTC 10 kΩ B = vertical 7 pins NTC 100 kΩ	Blank = unplated P = tin plated D = unplated and DMC R = tin plated and DMC
D - molex® Duraclik	R = right angle 7 pins C = right angle 7 pins NTC 10 kΩ D = right angle 7 pins NTC 100 kΩ	Blank = unplated P = tin plated D = unplated and DMC R = tin plated and DMC

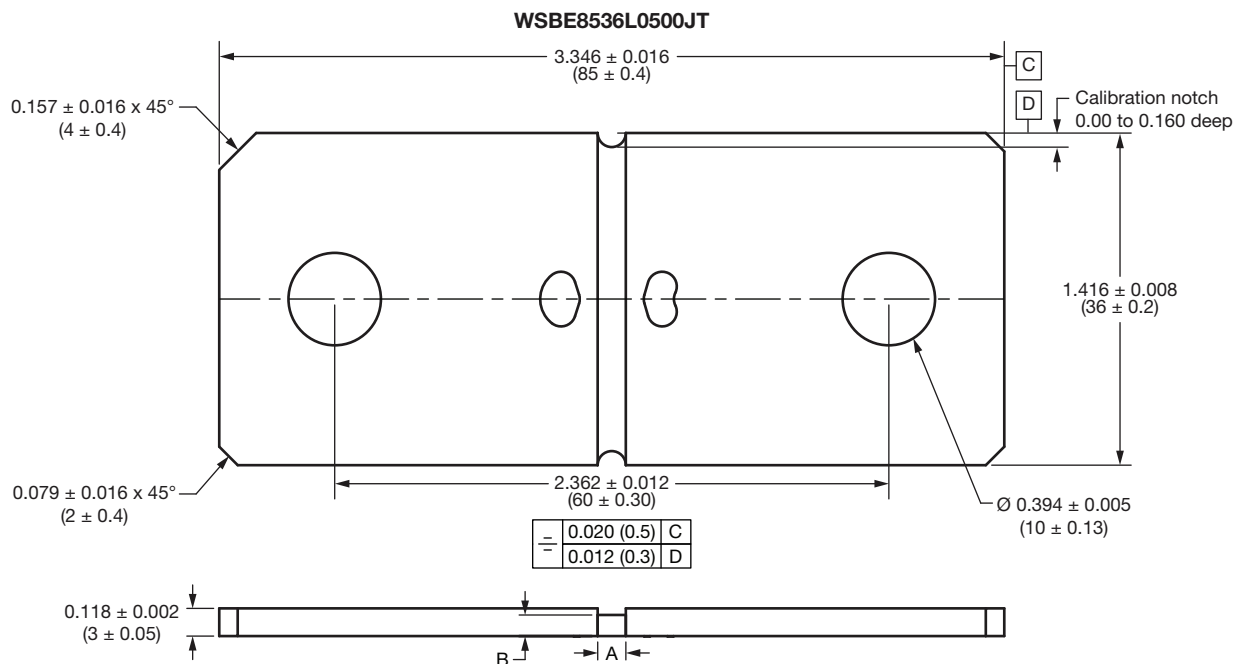
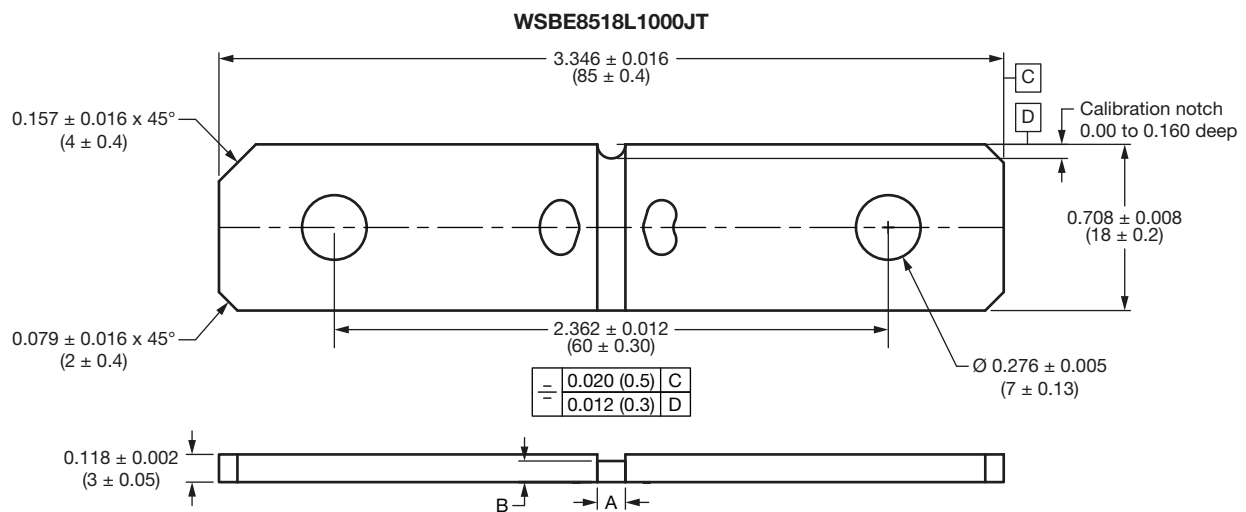
**DIMENSIONS** in inches (millimeters)

**CONNECTION OPTIONS**

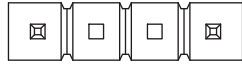

Voltage sense pins in position 1 and 4,  
position 2 and 3 are blank.

**A2 Series - Samtec®**

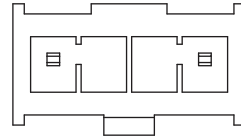

Voltage sense pins in position 1 and 4,  
position 2 and 3 are blank.

**B2 Series - Samtec®**



Voltage sense pins in position 1 and 4,  
ground pin in position 5,  
position 2 and 3 are blank.

**A3 Series - Samtec®**

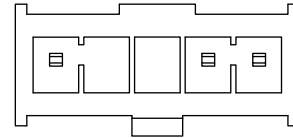

Voltage sense pins in position 1 and 4,  
ground pin in position 5,  
position 2 and 3 are blank.

**B3 Series - Samtec®**

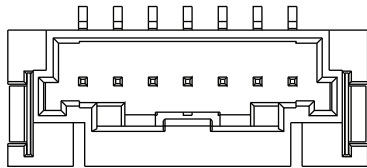

**DV Series - molex®**

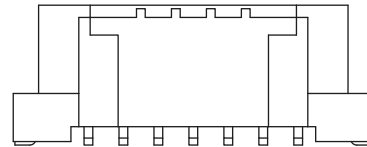

**DV Series - molex®**

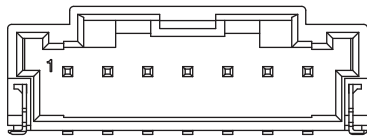

**DR Series - molex®**

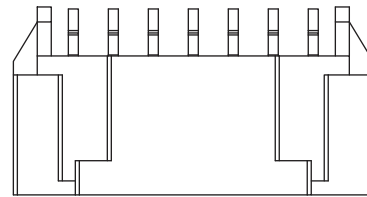

**DR Series - molex®**

**Notes**

- Connection options are examples. Other configurations available upon request (links to external website)
  - [A series connector](#) - modified with the middle two pins removed
  - [B series connector](#) - modified with the middle two pins removed
  - [B series female connector](#)
  - [Connector specifications datasheet](#)
  - [Duraclik vertical \(DV - 7 pin\)](#)
  - [Duraclik right angle \(DR - 7 pin\)](#)
- [Reference Designs | Vishay](#) - click for the landing page of all Vishay provided reference designs

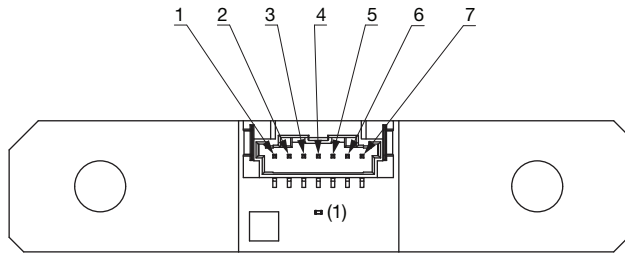
**molex® CONNECTOR LAYOUT**

CONNECTOR PIN	SIGNAL
1	GND
2	NTC 1N
3	SHUNT 2N
4	SHUNT 1N
5	SHUNT 1P
6	SHUNT 2P
7	NTC 1P

**Note**

 (1) NTCS0603E3103FLT [www.vishay.com/doc?29056](http://www.vishay.com/doc?29056)

NAME	EXPLANATION	START POSITION	NUMBER OF DIGITS	CODE
Lot number	Traceable to raw material	1	9	TM123456-
Drawing number	Customization of part/unique ID/DMC	10	7	1234567
Measured resistance	Actual resistance ( $\mu\Omega$ ) measured from connector	17	7	R51.10-
Date code	Year / month / day	24	6	250816
Shift identifier	What shift produced the part	30	1	C

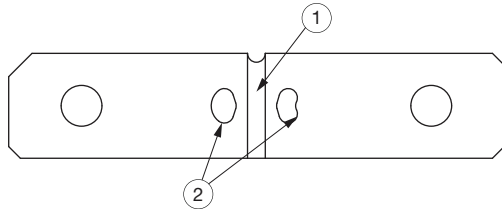
 $R_{th}$  = thermal resistance = (hotspot - terminal temperature) / applied power

- ① Hotspot = highest temperature of resistance element
- ② Terminal temperature = average temperature of region

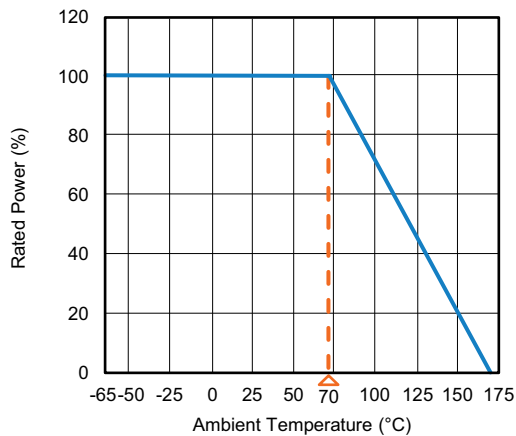
**DERATING**

SIZE	RESISTANCE VALUE ( $\mu\Omega$ )	ELEMENT MATERIAL	A REF.	B REF.	THERMAL RESISTANCE $R_{th}$ (°C/W)
8518	100	NiCr	0.120 (3.05)	0.090 (2.29)	0.9
8518	50	CuMn	0.160 (4.06)	0.050 (1.27)	0.8
8536	50	NiCr	0.120 (3.05)	0.090 (2.29)	0.5

 TOLERANCES ON DECIMALS  
 $.xxx \pm 0.005 [x \pm 0.1]$ 

UNLESS OTHERWISE LISTED



**TCR COMPARISON**

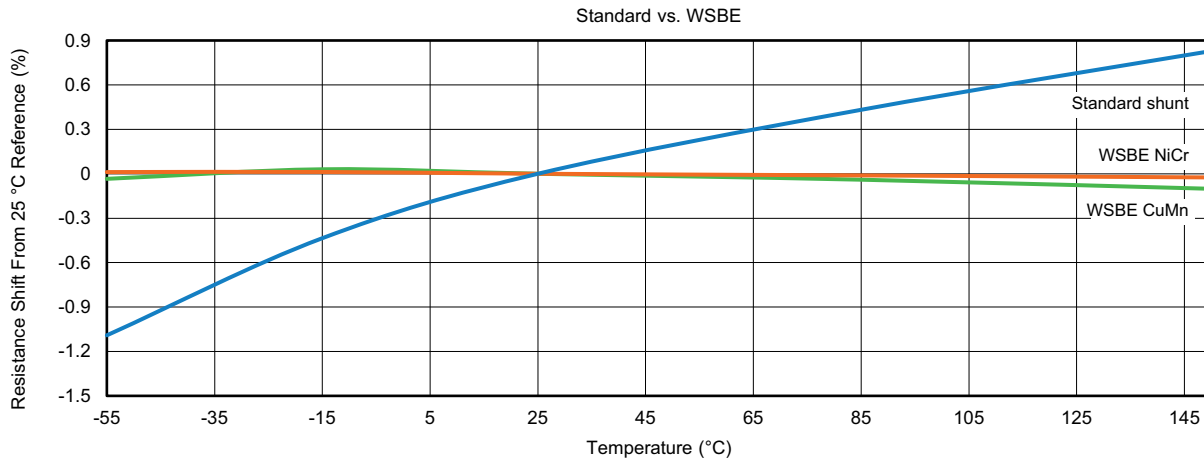

PERFORMANCE		
TEST	CONDITIONS OF TEST	TEST LIMITS
Thermal shock	-55 °C to +150 °C, 1000 cycles, 15 min at each extreme	± 0.5 % $\Delta R$
Short time overload	5 x rated power for 5 s	± 0.5 % $\Delta R$
Low temperature storage	-65 °C for 24 h	± 0.2 % $\Delta R$
High temperature exposure	1000 h at +170 °C	± 1.0 % $\Delta R$
Bias humidity	+85 °C, 85 % RH, 10 % bias, 1000 h	± 0.5 % $\Delta R$
Mechanical shock	100 g's for 6 ms, 5 pulses	± 0.2 % $\Delta R$
Vibration	Frequency varied 10 Hz to 2000 Hz in 1 min, 3 directions, 12 h	± 0.2 % $\Delta R$
Load life	1000 h at +70 °C, 1.5 h "ON", 0.5 h "OFF"	± 1.0 % $\Delta R$
Moisture resistance	MIL-STD-202, method 106, 0 % power, 7b not required	± 0.2 % $\Delta R$

LINKS TO RELATED DOCUMENTS	
<b>TECHNICAL NOTES</b>	
The Benefit of Using a Three Sense Pin Design on Battery / Meter Shunt Resistors	<a href="http://www.vishay.com/doc?30381">www.vishay.com/doc?30381</a>
<b>WHITE PAPERS</b>	
Temperature Coefficient of Resistance for Current Sensing	<a href="http://www.vishay.com/doc?30405">www.vishay.com/doc?30405</a>
<b>REFERENCE DESIGNS</b>	
HV-IBSS-CANFD	<a href="http://www.vishay.com/doc?15003">www.vishay.com/doc?15003</a>



## Disclaimer

ALL PRODUCT, PRODUCT SPECIFICATIONS AND DATA ARE SUBJECT TO CHANGE WITHOUT NOTICE TO IMPROVE RELIABILITY, FUNCTION OR DESIGN OR OTHERWISE.

Vishay Intertechnology, Inc., its affiliates, agents, and employees, and all persons acting on its or their behalf (collectively, "Vishay"), disclaim any and all liability for any errors, inaccuracies or incompleteness contained in any datasheet or in any other disclosure relating to any product.

Vishay makes no warranty, representation or guarantee regarding the suitability of the products for any particular purpose or the continuing production of any product. To the maximum extent permitted by applicable law, Vishay disclaims (i) any and all liability arising out of the application or use of any product, (ii) any and all liability, including without limitation special, consequential or incidental damages, and (iii) any and all implied warranties, including warranties of fitness for particular purpose, non-infringement and merchantability.

Statements regarding the suitability of products for certain types of applications are based on Vishay's knowledge of typical requirements that are often placed on Vishay products in generic applications. Such statements are not binding statements about the suitability of products for a particular application. It is the customer's responsibility to validate that a particular product with the properties described in the product specification is suitable for use in a particular application. Parameters provided in datasheets and / or specifications may vary in different applications and performance may vary over time. All operating parameters, including typical parameters, must be validated for each customer application by the customer's technical experts. Product specifications do not expand or otherwise modify Vishay's terms and conditions of purchase, including but not limited to the warranty expressed therein.

Hyperlinks included in this datasheet may direct users to third-party websites. These links are provided as a convenience and for informational purposes only. Inclusion of these hyperlinks does not constitute an endorsement or an approval by Vishay of any of the products, services or opinions of the corporation, organization or individual associated with the third-party website. Vishay disclaims any and all liability and bears no responsibility for the accuracy, legality or content of the third-party website or for that of subsequent links.

Vishay products are not designed for use in life-saving or life-sustaining applications or any application in which the failure of the Vishay product could result in personal injury or death unless specifically qualified in writing by Vishay. Customers using or selling Vishay products not expressly indicated for use in such applications do so at their own risk. Please contact authorized Vishay personnel to obtain written terms and conditions regarding products designed for such applications.

No license, express or implied, by estoppel or otherwise, to any intellectual property rights is granted by this document or by any conduct of Vishay. Product names and markings noted herein may be trademarks of their respective owners.