

Color: ■ white

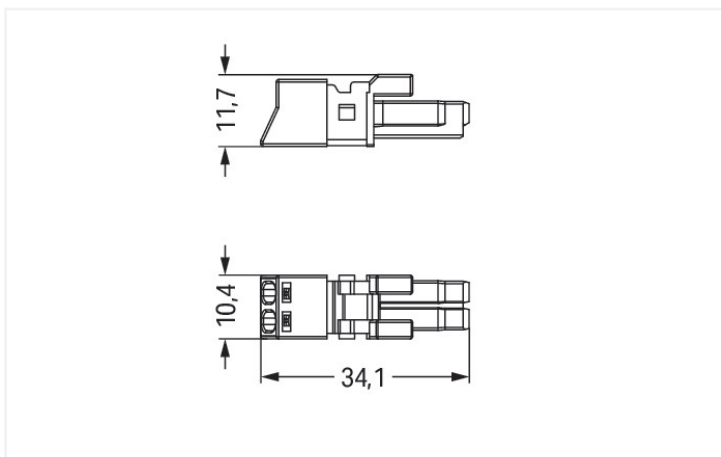

Dimensions in mm

Female connector/socket WINSTA® MINI 2-pole

For signal and power transmission: The WINSTA® MINI female connector/socket A coding. WAGO pluggable installation connectors are used when requirements repeat or are distributed on a specified grid, for example for installing grid lighting or flush-mount lighting. The coding options reduce installation errors, allowing fast, secure wiring of all components. The WINSTA® MINI pluggable installation connector with A coding in black or white is normally used for general mains applications in power distribution. WINSTA® MINI follows the trend towards miniaturisation. Our smallest pluggable connection system is primarily suited for lights, for example, since due to LED technology, these offer less and less space for the connection technology.

WINSTA® MINI solutions for your electrical installation – protected against mismatching and maintenance-free

WINSTA® is the pluggable connection system that is perfectly tailored to the strict requirements of electrical installation. It offers fast, secure and, above all, error-free installation of components and cables. Enjoy the benefits of the pluggable version of our maintenance-free spring pressure connection technology too! Plan your installation with with protection against mismatching from WAGO.

- effective protection against mismatching
- consistent IP40 protection
- suitable for any application
- custom-engineered solutions
- convenient installation and commissioning

Notes

General safety information

NOTICE: Observe installation and safety instructions!

- Nur von Elektrofachkraft oder einer für die Tätigkeit elektrisch unterwiesenen Person (EUP nach DIN VDE 0105-100) anzuwenden!
- Nicht unter Spannung/Last installieren!
- Nur für bestimmungsgemäßen Gebrauch einsetzen!
- Nationale Vorschriften/Normen/Richtlinien beachten!
- Technische Daten der Produkte beachten!
- Auf die richtige Polbelegung achten!
- Keine beschädigten/verschmutzten Komponenten verwenden!
- Leiterarten, -querschnitte, Abisolierlängen und Leitungsdurchmesser beachten!
- Leiter bis zum Anschlag einführen!
- Nur mit Verriegelungsklinke und Zugentlastung verwenden!
- Originalzubehör verwenden!

To be sold only with installation instructions!

Electrical data

Ratings per	IEC/EN 60664-1		
Overvoltage category	III	III	II
Pollution degree	3	2	2
Nominal voltage	250 V	-	-
Rated impulse withstand voltage	4 kV	-	-
Rated current	16 A	-	-

Approvals per	UL 1977
Rated voltage	600 V
Rated current	14 A

General information

Note on contact resistance	approx. 1 mΩ of contact resistance approx. 0.25 mΩ contact transition plug/ socket
----------------------------	--

Connection Data

Clamping units	2
Total number of potentials	2

Connection 1	
Connection technology	Push-in CAGE CLAMP®
Actuation type	Operating tool Push-in
Nominal cross-section	1.5 mm ² / 16 AWG
Solid conductor	0.25 ... 1.5 mm ² / 22 ... 16 AWG
Solid conductor; push-in termination	0.75 ... 1.5 mm ² / 20 ... 16 AWG
Stranded conductor	0.25 ... 1 mm ² / 22 ... 18 AWG
Fine-stranded conductor	0.25 ... 1.5 mm ² / 22 ... 16 AWG
Fine-stranded conductor; with insulated ferrule	0.25 ... 0.75 mm ² / 22 ... 20 AWG
Fine-stranded conductor; with uninsulated ferrule	0.25 ... 0.75 mm ² / 22 ... 20 AWG
Fine-stranded conductor; with ferrule; push-in termination	0.75 mm ² / 20 AWG
Strip length	9 mm / 0.35 inches
Pole number	2
Conductor entry direction to mating direction	0°

Physical data

Pin spacing	4.4 mm / 0.173 inches
Width	10.4 mm / 0.409 inches
Height	11.7 mm / 0.461 inches
Depth	34.1 mm / 1.343 inches

Mechanical data

Use	General mains applications
Coding	A
Variable coding	No
Marking	L N
Potential marking	L N
Mating force of a plug-in connection	approx. 20 ... 70 N (depending on pole number)
Retention force of a plug-in connection	Locked: > 80 N
Unmating force of a plug-in connection	Unlocked: approx. 20 ... 70 N (depending on pole number)
Number of mating cycles	200, without resistive load
Protection type	IP20; IP40 with strain relief housing

Plug-in connection

Contact type (pluggable connector)	Female connector/socket
Connector (connection type)	for conductor
Mismating protection	Yes
Note on mismating protection	All WINSTA® components are 100% protected against mismating when: a.) plugging different numbers of poles b.) plugging while rotated 180 c.) plugging while laterally staggered d.) plugging one pole
Locking lever	Can be retrofitted
Locking of plug-in connection	Locking lever
Note on locking system	All connectors for mounted installations (snap-in versions for lighting fixtures or devices, all types of PCB and distribution connectors) are factory-equipped with locking levers to ensure plugs and sockets are securely locked. Additional locking levers are only required for flying leads (plug/socket).

Material data

Note (material data)	Information on material specifications can be found here
Color	white
Cover color	gray
Material group	I
Insulation material (main housing)	Polyamide (PA66)
Flammability class per UL94	V0
Clamping spring material	Chrome-nickel spring steel (CrNi)
Contact material	Copper or copper alloy; surface-treated
Contact Plating	Tin
Fire load	0.076 MJ
Weight	2.6 g

Environmental requirements

Processing temperature	-5 ... +40 °C
Continuous operating temperature	-35 ... +85 °C
Note on continuous operating temperature	Insulating parts for temperatures ≤ 105 °C

Commercial data

Product Group	20 (Winsta)
PU (SPU)	50 pcs
Packaging type	Box
Country of origin	PL
GTIN	4055143548465
Customs tariff number	85366990990

Product Classification

UNSPSC	39121409
eCl@ss 10.0	27-44-06-05
eCl@ss 9.0	27-44-06-05
ETIM 9.0	EC002560
ETIM 10.0	EC002560
ECCN	NO US CLASSIFICATION

Environmental Product Compliance

RoHS Compliance Status	Compliant, No Exemption
------------------------	-------------------------

Approvals / Certificates

General approvals



Approval	Standard	Certificate Name
CCA DEKRA Certification B.V.	EN 61535	71-123231
CCA DEKRA Certification B.V.	IEC 61535	NL-85020
cURus Underwriters Laboratories Inc.	UL 1977	E45171

Declarations of conformity and manufacturer's declarations

Approval	Standard	Certificate Name
EU-Declaration of Confor- mity WAGO GmbH & Co. KG	-	-
UK-Declaration of Confor- mity WAGO GmbH & Co. KG	-	-

Approvals for marine applications



Approval	Standard	Certificate Name
ABS American Bureau of Ship- ping	Steel Vessel Rules	24-0095973-PDA
DNV GL Det Norske Veritas, Ger- manischer Lloyd	-	TAE00001Z6
LR Lloyds Register	EN 61535	08/20047 (E2)
PRS Polski Rejestr Statków	-	TE/1096/880590/23

Downloads

Environmental Product Compliance

Compliance Search			
Environmental Product Compliance 890-222			↓

Documentation

Bid Text			
890-222	19.02.2019	xml 2.95 KB	↓
890-222	08.06.2015	doc 22.50 KB	↓

CAD/CAE-Data

CAD data	
2D/3D Models 890-222	↓

CAE data	
EPLAN Data Portal 890-222	↓
WSCAD Universe 890-222	↓
ZUKEN Portal 890-222	↓

1 Compatible Products

1.1 System counterpart

1.1.1 Cable assembly



Item No.: 891-8992/205-102
pre-assembled connecting cable; Eca; Plug/open-ended; 2-pole; Cod. A; H05VV-F 2 x 1.0 mm²; 1 m; 1,00 mm²; white

Item No.: 891-8992/005-102
pre-assembled interconnecting cable; Eca; Socket/plug; 2-pole; Cod. A; H05VV-F 2 x 1.0 mm²; 1 m; 1,00 mm²; white

1.1.2 Distribution connector



Item No.: 890-1684
h-distribution connector; 2-pole; Cod. A; 1 input; 2 outputs; outputs on one side; 2 locking levers; white

Item No.: 890-1686
h-distribution connector; 2-pole; Cod. A; 1 input; 2 outputs; outputs on one side; 3 locking levers; for flying leads; white

Item No.: 890-1656
T-distribution connector; 2-pole; Cod. A; 1 input; 2 outputs; 2 locking levers; white

Item No.: 890-1665
T-distribution connector; 2-pole; Cod. A; 1 input; 2 outputs; 3 locking levers; for flying leads; white

1.1.3 Male connector/plug



Item No.: 890-832/011-000

Plug for PCBs; angled; 2-pole; Cod. A; white

Item No.: 890-832

Plug for PCBs; straight; 2-pole; Cod. A; white

Item No.: 890-232

Plug; 2-pole; 1,50 mm²; white

Item No.: 890-132

Plug; with strain relief housing; 2-pole; 1,50 mm²; white



Item No.: 890-732

Snap-in plug; 2-pole; Cod. A; 1,50 mm²; white

1.2 Required Accessories

1.2.1 Locking system

1.2.1.1 Locking system



Item No.: 890-111

Locking lever; for flying leads; for tool operation; black

Item No.: 890-131

Locking lever; for flying leads; for tool operation; white

Item No.: 890-101

Locking lever; for manual operation; black

Item No.: 890-121

Locking lever; for manual operation; white

1.2.2 Strain relief

1.2.2.1 Strain relief housing



Item No.: 890-502/342-000

Strain relief housing; 2-pole; with locking clip; for 1 cable; 3.8 ... 8.2 mm; 17.5 mm; black

Item No.: 890-512/342-000

Strain relief housing; 2-pole; with locking clip; for 1 cable; 3.8 ... 8.2 mm; 17.5 mm; white

Item No.: 890-502

Strain relief housing; 2-pole; with locking clip; for 1 cable; 3.8 ... 8.2 mm; 30 mm; black

Item No.: 890-512

Strain relief housing; 2-pole; with locking clip; for 1 cable; 3.8 ... 8.2 mm; 30 mm; white

1.3 Optional Accessories

1.3.1 Cover

1.3.1.1 Cover



Item No.: 897-2001

Protective cap; Type 1; for sockets and plugs; PVC; red

1.3.2 Installation

1.3.2.1 Mounting accessories



Item No.: 890-310

Mounting carrier; 2- to 5-pole; for flying leads; black

Item No.: 890-311

Mounting carrier; 2- to 5-pole; for flying leads; white

1.3.3 Tool

1.3.3.1 Operating tool



Item No.: [890-382](#)

Operating tool; 2-way; green



Item No.: [210-719](#)

Operating tool; Blade: 2.5 x 0.4 mm; with a partially insulated shaft

Installation Notes

Conductor termination

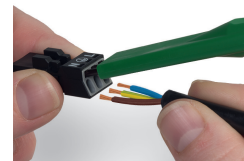
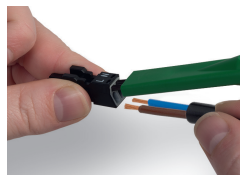
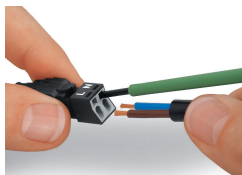
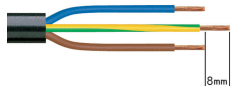

1. Strip length, outer insulation = 30 mm (2-pole), 37 mm (3-pole), 45 mm (4- and 5-pole)
2. Strip length = 9 mm
3. Extended ground conductor = 8 mm

To terminate fine-stranded conductors, open the clamping unit via screwdriver – 2.5 mm blade width – and insert a stripped conductor until it hits the backstop. Terminate solid conductors by simply pushing them in.

To terminate fine-stranded conductors, open clamping units via operating tool (890-382) and insert stripped conductors until they hit backstop. Terminate solid conductors by simply pushing them in.

To terminate fine-stranded conductors, open clamping units via operating tool (890-383) and insert stripped conductors until they hit backstop. Terminate solid conductors by simply pushing them in.

Installation

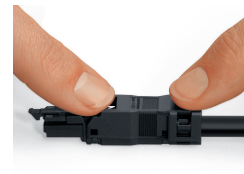
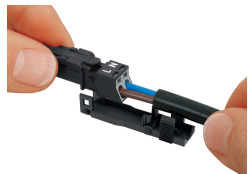

Latch the wired connector into the base of the strain relief housing.

Push down strain relief clamp by hand.

Push down strain relief clamp with 2.5 mm screwdriver alternately on both sides.

Latch the top of the strain relief housing.



The printed marking of the connector is clearly visible in the openings of the strain relief housing.