

POWER RELAY

1 POLE - 5A MEDIUM LOAD CONTROL

JV Series

RoHS Compliant

■ FEATURES

- UL, CSA, VDE, CQC recognized
- Low profile and space saving
 - Height: 12.5mm
 - Mounting space: 175mm²
- High sensitivity in small package
 - Operating power: 0.113 to 0.13W
 - Nominal power: 0.2 to 0.3W
- High insulation with reinforced insulation system (between coil and contacts)
 - Insulation distance: 8mm
 - Dielectric strength: 5,000VAC
 - Surge strength: 10,000V
- Plastic materials
 - UL94 flame class V-0
 - UL CTI level class 2
- Plastic sealed type, RTIII
- RoHS compliant



■ APPLICATIONS

EU standard-compliant equipment, OA equipment etc.

■ PART NUMBERS

[Example] JV - 12 S - K I
 (a) (b) (c) (d) (e)

(a)	Relay type	JV series
(b)	Coil rated voltage	12 : 3...48VDC Please refer to coil rating table
(c)	Coil type	Nil : Standard type (300mW) S : High sensitive type (200mW)
(d)	Enclosure	K : Plastic sealed type, RTIII
(e)	Construction	T : Insertion error preventing structure

Actual marking does not carry the the hyphen after series name.

■ SPECIFICATIONS

Item		Specifications		Remarks/Conditions	
		Standard type JV-()	High sensitive type JV-()S		
Contact Data	Configuration	1a (1 Form A, SPST-NO)			
	Construction	Single			
	Material	Silver alloy			
	Resistance (initial)	Max. 70 mΩ		At 1A, 6VDC	
	Contact rating	5A, 250VAC/30VDC		Resistive load	
	Max. carrying current	5A			
	Max. switching voltage	250VAC/150VDC			
	Max. switching power	1,250VA/150W			
	Max. switching current	5A			
	Min. switching load *1	100mA, 5VDC			
Coil	Rated power (at 20°C)	300mW	200mW		
	Operate power (at 20°C)	130mW	113mW		
	Operating temperature range	-40°C to +70°C		No frost	
Time	Operate (at nominal voltage)	Max. 8 ms		Without bounce	
	Release (at nominal voltage)	Max. 4 ms		No diode	
Life	Mechanical	Min. 5 x 10 ⁶ operations			
	Electrical	Min. 100 x 10 ³ operations			
Insulation	Insulation resistance (initial)	Min 1,000MΩ		At 500VDC	
	Dielectric strength	Open contacts	750VAC, 1 min.		
		Coil to contacts	5,000VAC, 1 min.		
Surge strength	Coil to contacts	10,000V / 1.2 x 50μs standard wave			
Others	Vibration resistance	Misoperation	10 to 55 to 10Hz single amplitude 0.825mm		Coil ON/OFF, 3 axis, total 6 cycles
		Endurance	10 to 55 to 10Hz double amplitude 2.5mm		Coil OFF, 3 axis, total 6 hours
	Shock resistance	Misoperation	Min. 100m/s ² (11±1ms)		Coil ON/OFF, 3 axis, total 36 operations
		Endurance	Min. 1,000m/s ² (6±1ms)		Coil OFF, 3 axis, total 18 operations
	Dimensions / Weight	10.0 x 17.5 x 12.5mm / Approx. 4.3g			
	Sealing	Plastic sealed RTIII			

*1: Minimum switching loads mentioned above are reference values. Please perform the confirmation test with actual load before production since reference values may vary according to switching frequencies, environmental conditions and expected reliability levels.

■ COIL DATA

● Standard type (300mW)

Coil Code	Rated Coil Voltage (VDC)	Coil Resistance (Ω) \pm 10%	Must Operate Voltage* (VDC)	Must Release Voltage* (VDC)	Rated Power (mW)
3	3	30	1.98	0.15	300
5	5	83.3	3.3	0.25	
6	6	120	3.96	0.3	
9	9	270	5.94	0.45	
12	12	480	7.9	0.6	
18	18	1,080	11.9	0.9	
24	24	1,920	15.8	1.2	
48	48	7,680	31.7	2.4	

● High sensitive type (200mW)

Coil Code	Rated Coil Voltage (VDC)	Coil Resistance (Ω) \pm 10%	Must Operate Voltage* (VDC)	Must Release Voltage* (VDC)	Rated Power (mW)
3	3	45	2.25	0.15	200
5	5	125	3.75	0.25	
6	6	180	4.5	0.3	
9	9	405	6.75	0.45	
12	12	720	9.0	0.6	
18	18	1,620	13.5	0.9	
24	24	2,880	18.0	1.2	

Note: All values in the table are valid at 20°C and zero contact current, unless otherwise specified.

*: Specified operated values are valid for pulse wave voltage.

! Please use at rated coil voltage. Please refer to characteristic data and set up adequate voltage in case of use at over voltage.

SAFETY STANDARDS

Type	Compliance	Contact Rating
UL	Flammability: UL 94-V-0 (plastics)	5A, 250 VAC / 30 VDC (resistive) 1/8 HP, 125VAC/250VAC Pilot duty: C300
	UL 508, UL 873 File No. E56140	
CSA	C22.2 No. 14 File No. LR40304	
VDE	IEC/EN61810-1 EN60335-1 clause 15.3; 16.3; 29.1; 29.2; 29.3 EN60730-1 clause 12.2; 13.2; 20.1; 20.2; 20.3	5A, 250VAC (cosφ=1)
CQC	GB/T21711.1, GB15092 File No. 170002164384	[JV-()S-KT] 5A 250VAC

Coil voltage is in ().

DIMENSIONS

● Dimensions

● Schematics (BOTTOM VIEW)

● PC board mounting hole layout (BOTTOM VIEW)

* Dimensions of the terminals do not include thickness of pre-soldering.
 * Dimensions do not include tolerances.
 * Tolerance of PC board mounting hole layout : ±0.1 unless otherwise specified.

Unit: mm
(): Reference

PART NUMBER LIST

Part Number	Rated Coil Power	Enclosure	Construction	Safety Standards
JV-()-KT	300mW	Plastic sealed	Insertion error preventing structure	UL, CSA, VDE, CQC
JV-()S-KT	200mW			

Coil voltage is in ().

CHARACTERISTIC DATA

(Characteristic data is not guaranteed value but measured values of samples from production line.)

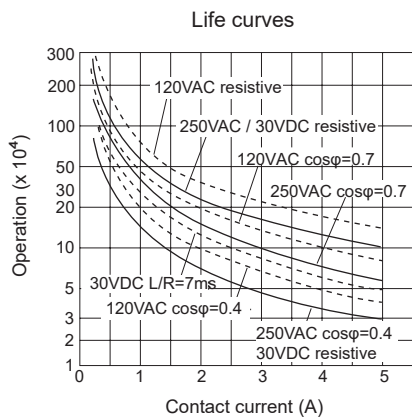
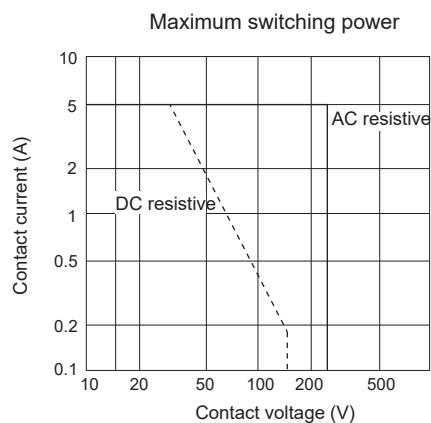
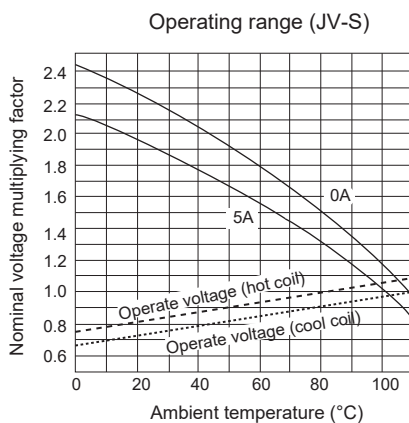
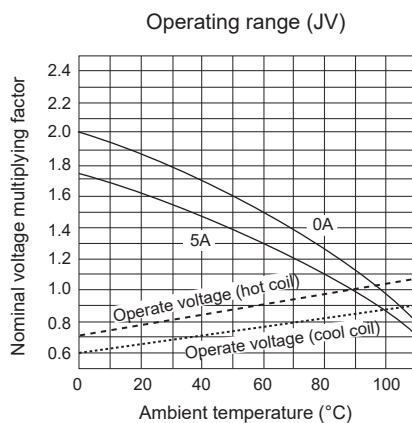
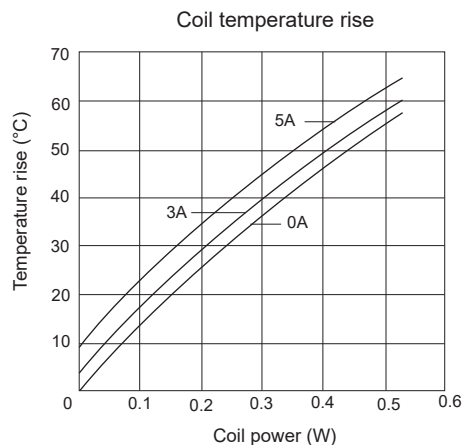
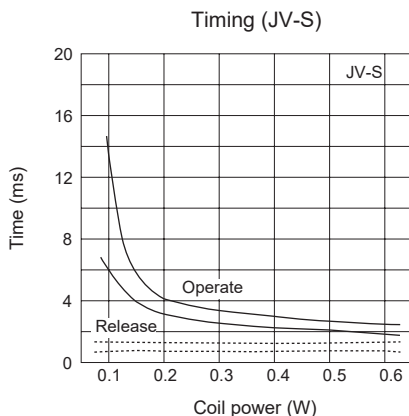
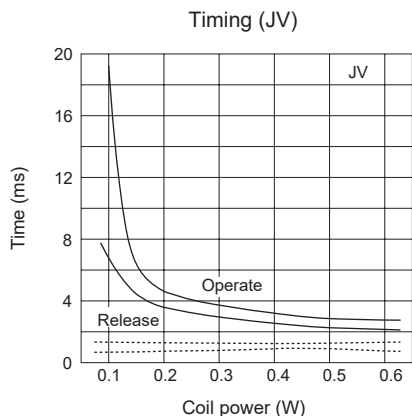

CHARACTERISTIC DATA

(Characteristic data is not guaranteed value but measured values of samples from production line.)

Distribution of operate/release voltage

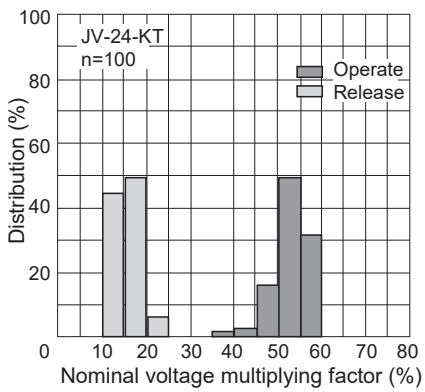

Distribution of operate/release time

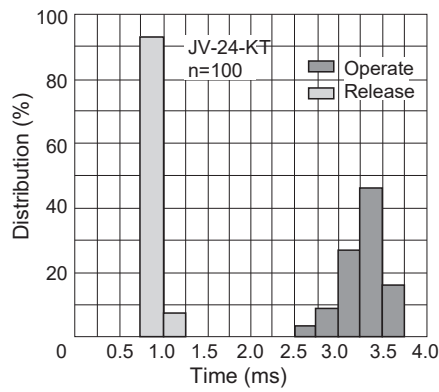

Distribution of contact resistance

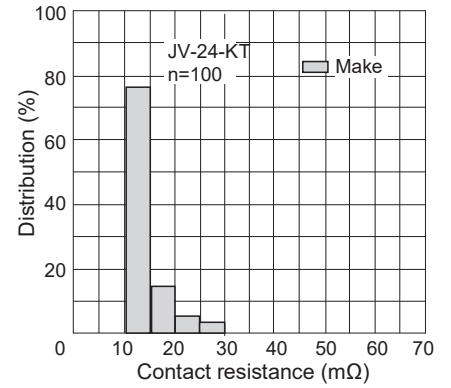

Mechanical life test

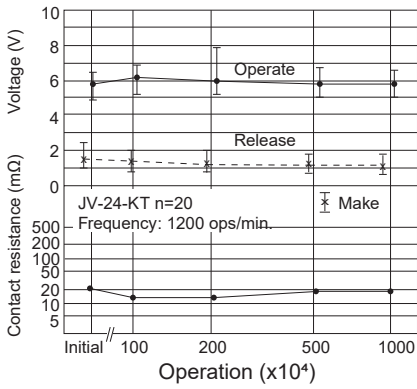

Electrical life test

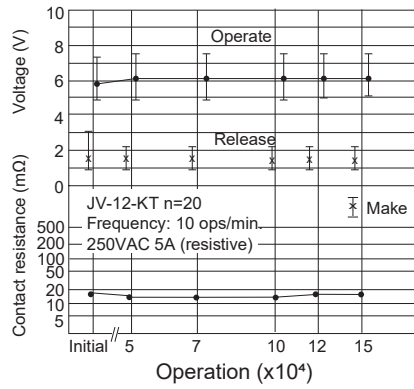

Electrical life test

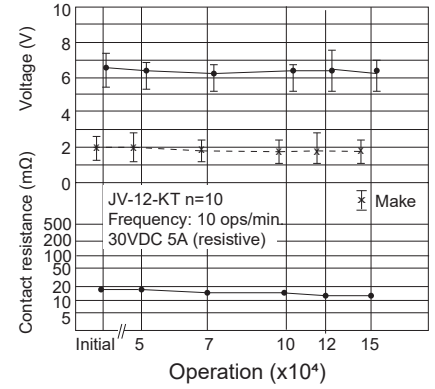

CAUTIONS

- All values mentioned in this datasheet are provided under ideal conditions. Please perform the confirmation test before actual use.
- Reflow soldering is prohibited.
- Do not use relays in the atmosphere with sulfide gas, chloride gas or nitric oxide. Contact resistance may increase.
- Do not use silicon or silicon-containing product or materials near relays. It may cause contact failure.

GENERAL INFORMATION

1. RoHS Compliance

- All relays produced by FCL Components are compliant with RoHS directive 2011/65/EU, including commission delegated directive 2015/863.

2. Recommended lead free solder condition

- Lead free solder plating on relay terminals is Sn-3.0Ag-0.5Cu, unless otherwise specified. This material has been verified to be compatible with PbSn assembly process.
- Recommended solder for assembly: Sn-3.0Ag-0.5Cu.

Flow Solder Condition:

Pre-Heating: Maximum 120°C within 90 sec.

Soldering: Dip within 5 sec. at 255°C±5°C solder bath

Relay must be cooled by air immediately after soldering

Solder by Soldering Iron:

Soldering Iron: 30-60W

Temperature: Maximum 340-360°C

Duration: Maximum 3 sec.

We highly recommend that you confirm your actual solder conditions

3. Moisture Sensitivity

- Moisture Sensitivity Level standard is not applicable to electromechanical relays, unless otherwise indicated.

4. Tin Whiskers

- Dipped SnAgCu solder is known as presenting a low risk to tin whisker development. No considerable length whisker was found by our in-house test.

Contact

Japan

FCL COMPONENTS LIMITED
Shinagawa Seaside Park Tower
12-4, Higashi-shinagawa 4-chome,
Tokyo 140 0002, Japan
Tel: +81-3-3450-1682
Email: fcl-contact@cs.fcl-components.com

North and South America

FCL COMPONENTS AMERICA, INC.
2055 Gateway Place Suite 480,
San Jose, CA 95110 USA
Tel: +1-408-745-4900
Email: contact@fcl-components.us

Europe

FCL COMPONENTS EUROPE B.V.
Diamantlaan 25
2132 WV Hoofddorp, Netherlands
Tel: +31-23-556-0910
Email: info@fcl-components.eu

Asia Pacific

FCL COMPONENTS ASIA PTE LTD.
No. 20 Harbour Drive, #07-01B
Singapore 117612
Tel: +65-6375-8560
Email: fcals@fcl-components.com

China

FCL COMPONENTS (SHANGHAI) CO.,LTD.
Unit 1105, Central Park - Jing An,
No.329 Heng Feng Road, Shanghai
200070, China
Tel: +86-21-3253 0998
Email: fcsh@fcl-components.com

Hong Kong

FCL COMPONENTS HONG KONG CO.,
LIMITED
Unit 2313, Seapower Tower, Concordia
Plaza, No.1 Science Museum Road,
TST, Kowloon, Hong Kong
Tel: +852-2881-8495
Email: fcals@fcl-components.com

Web: www.fcl-components.com/en/

© 2025 FCL Components Limited. All rights reserved. All trademarks or registered trademarks are the property of their respective owners.

FCL Components Products are intended for general use, including without limitation, in personal, household and office environments, in buildings and for ordinary use in the industry. FCL Components Products are not intended to be used in applications where extremely high safety is required ("High Safety Required Applications"), such as, but not limited to, applications in nuclear facilities, in aircraft automatic flight control, in air traffic control, in mass transit system control, in missile launch system, in weapon systems, in medical equipment for life support or any application involving a direct serious risk of physical injury or death.

Please do not use FCL Components Products without securing the sufficient safety and reliability required for the High Safety Required Applications.

In addition, FCL Components shall not be liable against the customer and/or any third party for any claims or damages arising in connection with the use of FCL Components Products in the High Safety Required Applications.

FCL Components warrants that its Products, if properly used and services, will conform to their specification and will be free from defects in material and workmanship for twelve months from delivery.

The implied warranties of merchantability and fitness for a particular purpose and all other warranties, representations and conditions, express or implied by statute, trade usage or otherwise, except as set forth in this warranty, are excluded and shall not apply to the Products delivered.

The contents, data and information in this datasheet are provided by FCL Components Limited as a service only to its user and only for general information purposes. The use of the contents, data and information provided in this datasheet is at the users' own risk.

FCL Components has assembled this datasheet with care and will endeavor to keep the contents, data and information correct, accurate, comprehensive, complete and up to date.

FCL Components Limited and affiliated companies do however not accept any responsibility or liability on their behalf, nor on behalf of its employees, for any loss or damage, direct, indirect or consequential, with respect to this datasheet, its contents, data, and information and related graphics and the correctness, reliability, accuracy, comprehensiveness, usefulness, availability and completeness thereof. Nor do FCL Components Limited and affiliated companies accept on their behalf, nor on behalf of its employees, any responsibility or liability with respect to these datasheets, its contents, data, information and related graphics and the correctness, reliability, accuracy, comprehensiveness, usefulness, availability and completeness thereof. Rev. January 10, 2025.