

**Bottom View of Assembly**

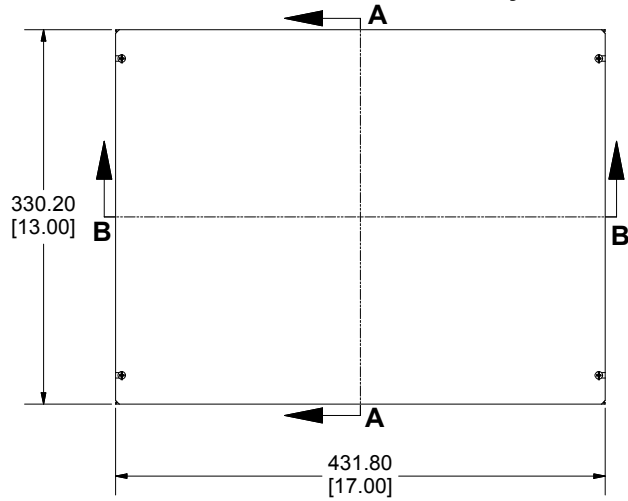

**SECTION A-A  
End View of Assembly**

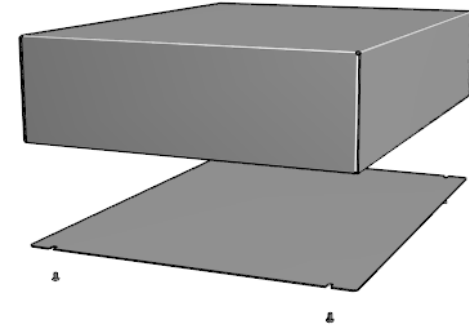
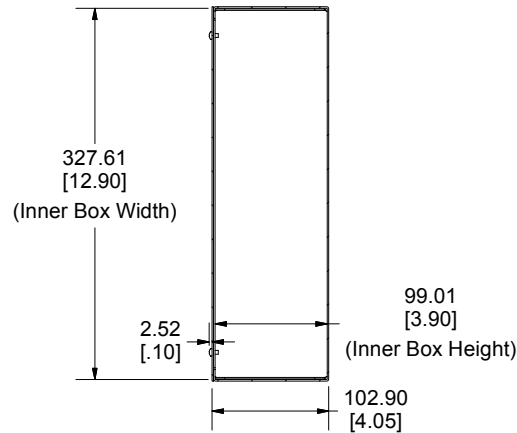

**SECTION B-B  
Side View of Assembly**

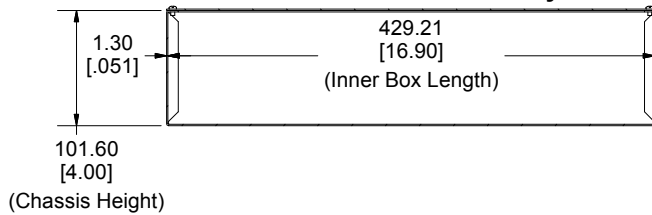

**Bottom View of Chassis  
(Sold Separately)**

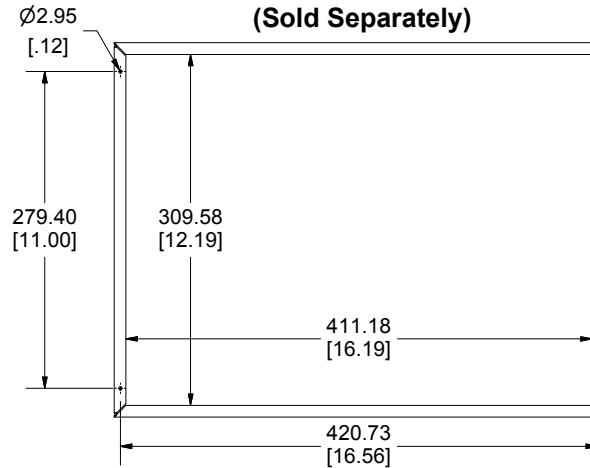

**Bottom Plate  
(Sold Separately)**

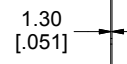
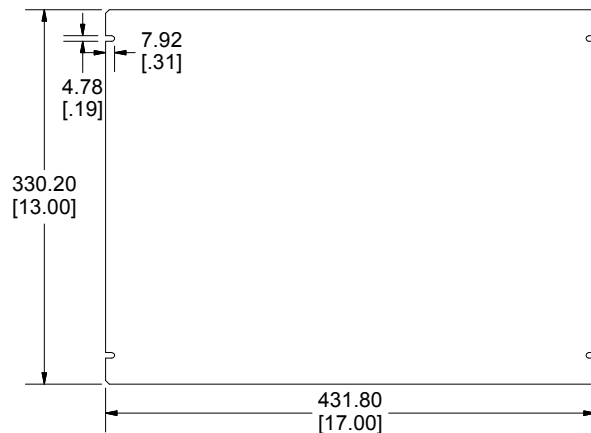

Enclosures can be Factory Modified ( Milling, Drilling, Printing etc.)  
Contact Factory [mjm@hammondmfg.com](mailto:mjm@hammondmfg.com) for quotes  
Solid models of this enclosure available in STEP or IGES.

**NOTE**

All Components Sold Separately  
Chassis is Made of 0.051" Aluminum.  
Bottom Plate is Made of 0.051" Aluminum.

**PART NUMBERS**

1444-17134 Enclosure

Natural Finish Chassis

1444-17134

**ACCESSORIES**

Natural Finish Bottom Plate

1434-1713

Plated Cover Screws (Pkg 6)

1421J6

[6-32 x 1/4" Self-Tapping Screws]



**HAMMOND  
MANUFACTURING™**

**1444-17134**

[www.hammondmfg.com](http://www.hammondmfg.com)

Dimensions:  
mm  
[inches]