

Data Sheet | Item Number: 285-150

2-conductor through terminal block; 50 mm²; lateral marker slots; only for DIN 35 x 15 rail; POWER CAGE CLAMP; 50,00 mm²; gray

<https://www.wago.com/285-150>

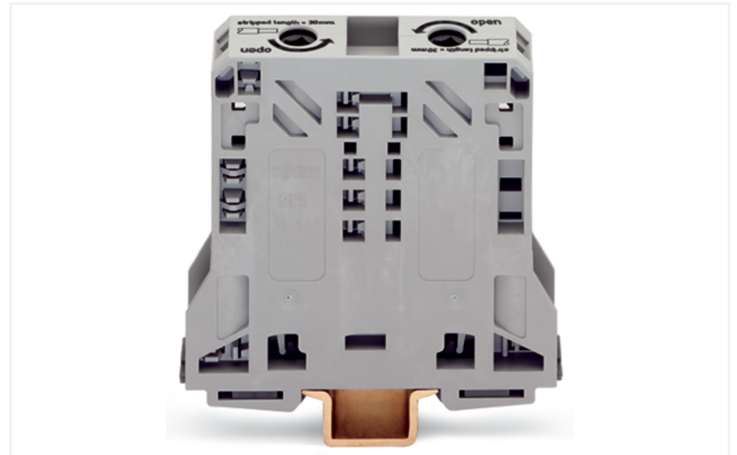
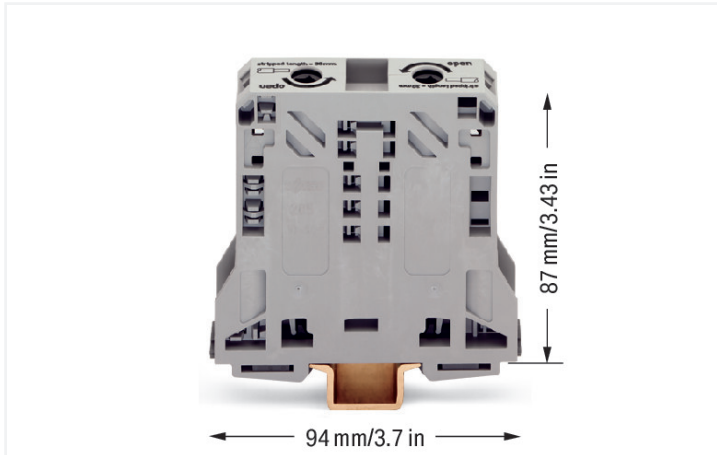

Color: ■ gray

High-current terminal block, 285 Series, gray

Our through terminal block (item number 285-150) simplifies electrical installations. Strip lengths must be 32 mm when connecting conductors to this through terminal block. This product features conductor terminals and utilizes POWER CAGE CLAMP. The POWER CAGE CLAMP is perfect for connecting large conductor cross-sections. This universal connector is both reliable and maintenance-free. What's more, you can use it to connect all types of conductors and the clamping point can be locked open, making it easier to use. You do not need to use a torque wrench or prepare the conductor. For example, crimping ferrules is not necessary. This through terminal block is suitable for conductor cross sections ranging from 10 mm² to 50 mm².

Electrical data

Ratings per	IEC/EN 60947-7-1		
Overtoltage category	III	III	II
Pollution degree	3	2	2
Nominal voltage	1000 V	-	-
Rated impulse withstand voltage	8 kV	-	-
Rated current	150 A	-	-

Approvals per	UL 1059		
Use group	B	C	D
Rated voltage	600 V	600 V	-
Rated current	150 A	150 A	-

Approvals per	CSA 22.2 No 158		
Use group	B	C	D
Rated voltage	600 V	600 V	-
Rated current	150 A	-	-

Power Loss	
Power loss, per pole (potential)	4.725 W
Rated current I_N for power loss specification	150 A
Resistance value for specified, current-dependent power loss	0.0001 Ω

General information

Wiring direction	Side-entry wiring
------------------	-------------------

Connection Data

Clamping units	2
Total number of potentials	1
Number of levels	1
Number of jumper slots	2

Connection 1

Connection technology	POWER CAGE CLAMP
Actuation type	T-wrench; 8 mm
Connectable conductor materials	Copper
Nominal cross-section	50 mm ²
Solid conductor	10 ... 50 mm ² / 8 ... 1/0 AWG
Stranded conductor	10 ... 50 mm ² / 8 ... 1/0 AWG
Fine-stranded conductor	10 ... 70 mm ² / 8 ... 2/0 AWG
Fine-stranded conductor; with insulated ferrule	10 ... 50 mm ² / 8 ... 1/0 AWG
Fine-stranded conductor; with uninsulated ferrule	10 ... 50 mm ² / 8 ... 1/0 AWG
Strip length	32 mm / 1.26 inches
Wiring direction	Side-entry wiring

Physical data

Width	20 mm / 0.787 inches
Height	94 mm / 3.701 inches
Depth from upper-edge of DIN-rail	87 mm / 3.425 inches

Mechanical data

Mounting type	DIN-35 x 15 rail
Mounting (note)	only suitable for DIN 35 x 15 rail
Marking level	Side marking

Material data

Note (material data)	Information on material specifications can be found here
Color	gray
Material group	I
Insulation material (main housing)	Polyamide (PA66)
Flammability class per UL94	V0
Fire load	1.92 MJ
Weight	158.7 g

Environmental requirements

Processing temperature	-35 ... +85 °C
Continuous operating temperature	-60 ... +105 °C

Environmental Testing

Test specification: Railway applications – Rolling stock – Electronic equipment	DIN EN 50155 (VDE 0115-200):2022-06
Test procedure: Railway applications – Rolling stock equipment – Vibration and shock tests	DIN EN 61373 (VDE 0115-0106):2011-04
Spectrum/Mounting location	Service life test, Category 1, Class A/B
Functional test with noise-like oscillations	Test passed according to Section 8 of the standard
Frequency	f ₁ = 5 Hz to f ₂ = 150 Hz
Acceleration	0.101g (highest test level used for all axes)
Test duration per axis	10 min.
Test directions	X, Y and Z axes

Environmental Testing

Monitoring of contact faults and interruptions	Passed
Voltage drop measurement before and after each axis	Passed
Simulated service life test through increased levels of noise-like oscillations	Test passed according to Section 9 of the standard
Frequency	$f_1 = 5 \text{ Hz}$ to $f_2 = 150 \text{ Hz}$
Acceleration	0.572g (highest test level used for all axes)
Test duration per axis	5 h
Test directions	X, Y and Z axes
Extended testing: Monitoring of contact faults and interruptions	Passed
Extended testing: Voltage drop measurement before and after each axis	Passed
Shock test	Test passed according to Section 10 of the standard
Shock pulse form	Half sine
Acceleration	5g (highest test level used for all axes)
Shock duration	30 ms
Number of shocks (per axis)	3 pos. und 3 neg.
Test directions	X, Y and Z axes
Extended testing: Monitoring of contact faults and interruptions	Passed
Extended testing: Voltage drop measurement before and after each axis	Passed
Vibration and shock stress for rolling stock equipment	Passed

Commercial data

Product Group	1 (Rail Mounted Terminal Blocks)
PU (SPU)	5 pcs
Packaging type	Box
Country of origin	PL
GTIN	4045454507411
Customs tariff number	85369010000

Product Classification

UNSPSC	39121410
eCl@ss 10.0	27-14-11-20
eCl@ss 9.0	27-14-11-20
ETIM 9.0	EC000897
ETIM 10.0	EC000897
ECCN	NO US CLASSIFICATION

Environmental Product Compliance

RoHS Compliance Status	Compliant, No Exemption
------------------------	-------------------------

Approvals / Certificates

General approvals



Approval	Standard	Certificate Name
CCA DEKRA Certification B.V.	EN 60947	NTR NL-7707
CSA CSA Group	C22.2	1151144
KEMA/KEUR DEKRA Certification B.V.	EN 60947	71-105562

Declarations of conformity and manufacturer's declarations



Approval	Standard	Certificate Name
EU-Declaration of Conformity WAGO GmbH & Co. KG	-	-
Railway WAGO GmbH & Co. KG	-	Z00004420.000
UK-Declaration of Conformity WAGO GmbH & Co. KG	-	-

Approvals for marine applications



Approval	Standard	Certificate Name
ABS American Bureau of Shipping	EN 60947	24-0152298-PDA
DNV GL Det Norske Veritas, Germanischer Lloyd	-	TAE00001V2

Downloads

Environmental Product Compliance

Compliance Search

Environmental Product Compliance 285-150	↓
--	-------------------

Documentation

Bid Text

Item Number	Date	File Name / Size	Action
285-150	19.02.2019	xml 3.25 KB	↓
285-150	04.01.2018	doc 23.50 KB	↓

CAD/CAE-Data

CAD data

2D/3D Models 285-150



CAE data

EPLAN Data Portal
285-150



WSCAD Universe
285-150



ZUKEN Portal 285-150



1 Compatible Products

1.1 Optional Accessories

1.1.1 Cover

1.1.1.1 Cover



[Item No.: 285-441](#)

Finger guard; touchproof cover protects unused conductor entries and jumper slots; for 50 mm² high-current tbs; yellow

1.1.2 Current and voltage tap

1.1.2.1 Current and voltage tap



[Item No.: 855-501/150-000](#)

Current and voltage tap up to 50 mm²; Primary rated current: 150 A; Secondary rated current: 1 A; Rated power: 0.2 VA; Accuracy class: 0.5; fused

1.1.3 DIN-rail

1.1.3.1 Mounting accessories



[Item No.: 210-198](#)

Copper carrier rail; 35 x 15 mm; 2.3 mm thick; 2 m long; unslotted; according to EN 60715; copper-colored



[Item No.: 210-508](#)

Steel carrier rail; 35 x 15 mm; 1.5 mm thick; 2 m long; slotted; galvanized; similar to EN 60715; silver-colored



[Item No.: 210-197](#)

Steel carrier rail; 35 x 15 mm; 1.5 mm thick; 2 m long; slotted; similar to EN 60715; silver-colored



[Item No.: 210-506](#)

Steel carrier rail; 35 x 15 mm; 1.5 mm thick; 2 m long; unslotted; galvanized; similar to EN 60715; silver-colored



[Item No.: 210-114](#)

Steel carrier rail; 35 x 15 mm; 1.5 mm thick; 2 m long; unslotted; similar to EN 60715; silver-colored

1.1.4 Ferrule

1.1.4.1 Ferrule



Item No.: 216-3427

Ferrule; Sleeve for 25 mm² / AWG 4; un-insulated; electro-tin plated; electrolytic copper; acc. to DIN 46228, Part 1/08.92



Item No.: 216-3112

Ferrule; Sleeve for 35 mm² / AWG 2; un-insulated; electro-tin plated; electrolytic copper; acc. to DIN 46228, Part 1/08.92



Item No.: 216-424

Ferrule; Sleeve for 35 mm² / AWG 2; un-insulated; electro-tin plated; electrolytic copper; gastight crimped; acc. to DIN 46228, Part 1/08.92; silver-colored



Item No.: 216-3113

Ferrule; Sleeve for 50 mm² / AWG 1; un-insulated; electro-tin plated; electrolytic copper; acc. to DIN 46228, Part 1/08.92



Item No.: 216-425

Ferrule; Sleeve for 50 mm² / AWG 1; un-insulated; electro-tin plated; electrolytic copper; acc. to DIN 46228, Part 1/08.92

1.1.5 Installation

1.1.5.1 Mounting accessories



Item No.: 285-448

Fixing element; for 50 mm² high-current terminal blocks; orange



Item No.: 249-197

Screwless end stop; 14 mm wide; for DIN-rail 35 x 15 and 35 x 7.5; gray

1.1.6 Jumper

1.1.6.1 Jumper



Item No.: 285-450

Jumper; insulated; gray

1.1.7 Marking

1.1.7.1 Group marker carrier



Item No.: 249-105

Group marker carrier; gray

1.1.7.2 Marker



Item No.: 793-5501/000-006

WMB marking card; as card; for terminal block width 5 - 17.5 mm; stretchable 5 - 5.2 mm; plain; snap-on type; blue



Item No.: 793-5501/000-014

WMB marking card; as card; for terminal block width 5 - 17.5 mm; stretchable 5 - 5.2 mm; plain; snap-on type; brown



Item No.: 793-5501/000-007

WMB marking card; as card; for terminal block width 5 - 17.5 mm; stretchable 5 - 5.2 mm; plain; snap-on type; gray



Item No.: 793-5501/000-023

WMB marking card; as card; for terminal block width 5 - 17.5 mm; stretchable 5 - 5.2 mm; plain; snap-on type; green



Item No.: 793-5501/000-017

WMB marking card; as card; for terminal block width 5 - 17.5 mm; stretchable 5 - 5.2 mm; plain; snap-on type; light green



Item No.: 793-5501/000-012

WMB marking card; as card; for terminal block width 5 - 17.5 mm; stretchable 5 - 5.2 mm; plain; snap-on type; orange



Item No.: 793-5501/000-005

WMB marking card; as card; for terminal block width 5 - 17.5 mm; stretchable 5 - 5.2 mm; plain; snap-on type; red



Item No.: 793-5501/000-024

WMB marking card; as card; for terminal block width 5 - 17.5 mm; stretchable 5 - 5.2 mm; plain; snap-on type; violet

1.1.7.2 Marker



Item No.: 793-5501

WMB marking card; as card; for terminal block width 5 - 17.5 mm; stretchable 5 - 5.2 mm; plain; snap-on type; white

Item No.: 793-5501/000-002

WMB marking card; as card; for terminal block width 5 - 17.5 mm; stretchable 5 - 5.2 mm; plain; snap-on type; yellow

Item No.: 793-501/000-006

WMB marking card; as card; not stretchable; plain; snap-on type; blue

Item No.: 793-501/000-007

WMB marking card; as card; not stretchable; plain; snap-on type; gray



Item No.: 793-501/000-023

WMB marking card; as card; not stretchable; plain; snap-on type; green

Item No.: 793-501/000-017

WMB marking card; as card; not stretchable; plain; snap-on type; light green

Item No.: 793-501/000-012

WMB marking card; as card; not stretchable; plain; snap-on type; orange

Item No.: 793-501/000-005

WMB marking card; as card; not stretchable; plain; snap-on type; red



Item No.: 793-501/000-024

WMB marking card; as card; not stretchable; plain; snap-on type; violet

Item No.: 793-501

WMB marking card; as card; not stretchable; plain; snap-on type; white

Item No.: 793-501/000-002

WMB marking card; as card; not stretchable; plain; snap-on type; yellow

Item No.: 2009-115/000-006

WMB-Inline; for Smart Printer; 1500 pieces on roll; stretchable 5 - 5.2 mm; plain; snap-on type; blue



Item No.: 2009-115/000-007

WMB-Inline; for Smart Printer; 1500 pieces on roll; stretchable 5 - 5.2 mm; plain; snap-on type; gray

Item No.: 2009-115/000-023

WMB-Inline; for Smart Printer; 1500 pieces on roll; stretchable 5 - 5.2 mm; plain; snap-on type; green

Item No.: 2009-115/000-017

WMB-Inline; for Smart Printer; 1500 pieces on roll; stretchable 5 - 5.2 mm; plain; snap-on type; light green

Item No.: 2009-115/000-012

WMB-Inline; for Smart Printer; 1500 pieces on roll; stretchable 5 - 5.2 mm; plain; snap-on type; orange



Item No.: 2009-115/000-005

WMB-Inline; for Smart Printer; 1500 pieces on roll; stretchable 5 - 5.2 mm; plain; snap-on type; red

Item No.: 2009-115/000-024

WMB-Inline; for Smart Printer; 1500 pieces on roll; stretchable 5 - 5.2 mm; plain; snap-on type; violet

Item No.: 2009-115

WMB-Inline; for Smart Printer; 1500 pieces on roll; stretchable 5 - 5.2 mm; plain; snap-on type; white

Item No.: 2009-115/000-002

WMB-Inline; for Smart Printer; 1500 pieces on roll; stretchable 5 - 5.2 mm; plain; snap-on type; yellow

1.1.7.3 Marker carrier



Item No.: 285-442

Adaptor; gray

1.1.8 Power tap

1.1.8.1 Power tap



Item No.: 285-447

Power tap; for 50 mm² high-current tbs; Module width 16 mm; gray

1.1.9 Protective warning marker

1.1.9.1 Cover



Item No.: 285-440

Protective warning marker; with high-voltage symbol, black; yellow

Item No.: 285-449

Protective warning marker; yellow

1.1.10 Tool

1.1.10.1 Operating tool



Item No.: 285-172

Allen wrench; with a partially insulated shaft; green

Item No.: 285-173

Allen wrench; with a partially insulated shaft; with anti-rotation protection; green

Installation Notes

Installation



Snapping a terminal block onto DIN-rail (to the left or to the right).

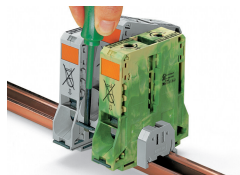

Removing a terminal block from the assembly (to the left or to the right).

Conductor termination



For the optimal clamping force:

- Bend conductor
- Cut conductor to length (conductor end must be straight)
- Strip conductor



Always observe the on-unit printed strip length guide!



Conductor termination – step 1:
Rotate the T-wrench counter-clockwise to the stop. Next, push in the orange locking tab. The clamp is locked open for hands-free wiring.

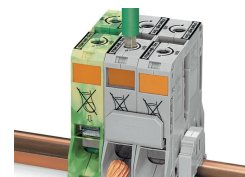

Conductor termination – step 2:
Insert a stripped conductor into the clamping unit until it hits the backstop. Hold in this position.



Conductor termination – step 3:
A short counter-clockwise rotation releases the tab. When unlocked, the T-wrench rotates clockwise, securely clamping the conductor.

Commoning

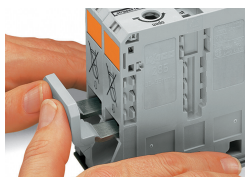

Commoning with an adjacent jumper: insert the jumper above the conductor entry hole – prior to conductor termination. The nominal cross-section remains unchanged.

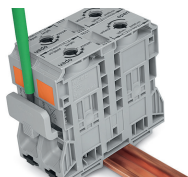

Removing jumper via operating tool.

Cover

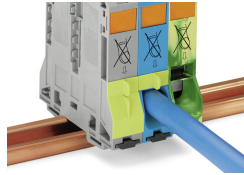
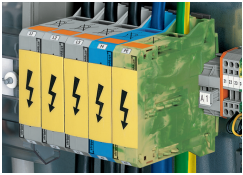

Protective warning marker may indicate:
Notice: Power is still on even after switching off the main switch!

Yellow, detachable finger guards provide touch-proof safety by shielding jumper contact slots and/or unused conductor entries.

Power tap

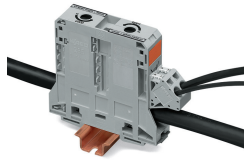

Easily and consistently tap directly into the power supply. Insert the unwired tap before opening the clamping unit.

Security

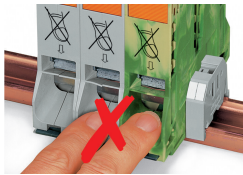

Risk of Injury!
Do not insert fingers in the conductor entry!

Testing

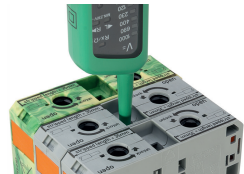

Testing via touch-proof 4 mm Ø test plugs (not available from WAGO, but offered by industry suppliers such as, Multi-Contact Deutschland GmbH).

Testing
Voltage measurements can be performed, e.g., using a 2-pole voltage tester (Item No. 206-707).

Marking

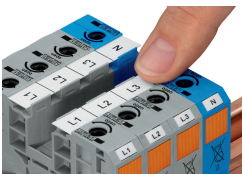

WMB markers or self-adhesive, printable marking strips can be accommodated on 35, 50 and 95 mm² high-current terminal blocks.

Marker carrier (Item No. 285-442) for marking strips (Item No. 2009-110) or 2 WMB markers for 285-13x, 285-15x and 285-19x Terminal Blocks

Subject to changes. Please also observe the further product documentation!

Current addresses can be found at: www.wago.com