



Power
Factor
Correction



World wide



Low Profile



Safety
Approvals



Inrush
current
limiting



OVP

DPG-series

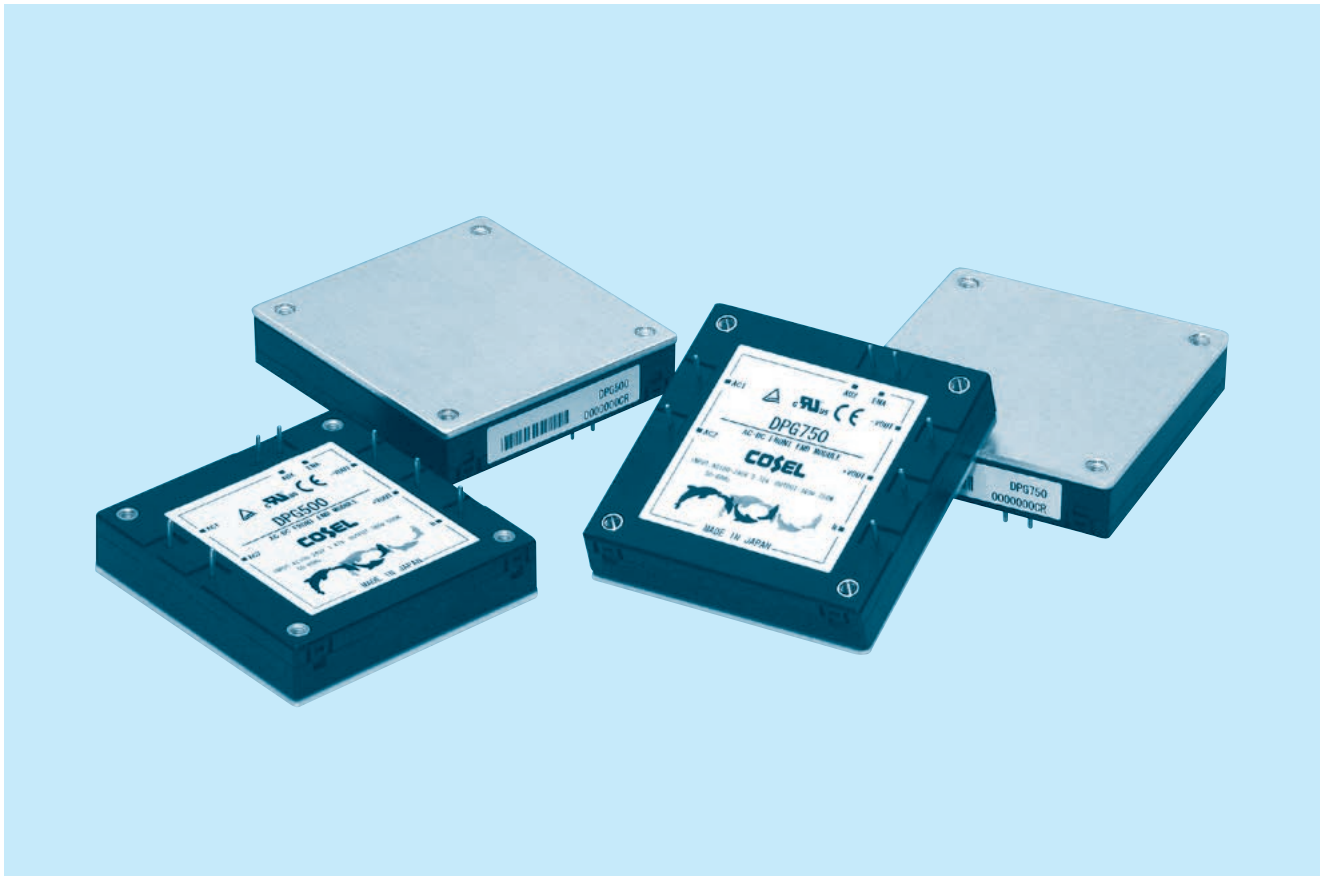

■ Power factor correction module

■ Feature

- Harmonic attenuator (Complies with IEC61000-3-2)
- High efficiency 93% (AC100V), 96% (AC200V)
- Universal input voltage (AC85 - 264V)
- Built-in inrush current protection
- Built-in overvoltage and thermal protection circuits
- Enable signal (ENA)
- Auxiliary power supply for external signal (AUX)
- Ideal for distributed power systems

■ 5-year warranty

■ CE marking

- Low Voltage Directive
- RoHS Directive

■ UKCA marking

- Electrical Equipment Safety Regulations
- RoHS Regulations

■ Safety agency approvals

- UL, C-UL recognized, TÜV approved

DPG

DPG 750 -□

① ② ③



- ① Series name
- ② Output power
500 : 500W (ACIN 200V)
750 : 750W (ACIN 200V)
- ③ Optional
T : with Mounting hole
(φ 3.4 thru)

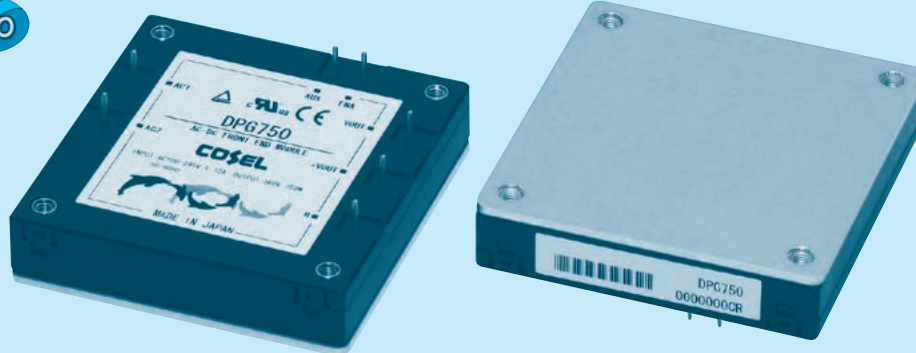

MODEL	DPG500		DPG750	
AC INPUT[V]	AC85 - 264	AC170 - 264	AC85 - 264	AC170 - 264
MAX OUTPUT WATTAGE[W]	*1 300	500	500	750
DC OUTPUT VOLTAGE[V]	*2 360			

SPECIFICATIONS

	MODEL	DPG500		DPG750	
INPUT	VOLTAGE[V]	AC85 - 264 1 φ	AC170 - 264 1 φ	AC85 - 264 1 φ	AC170 - 264 1 φ
	POWER FACTOR CORRECTION RANGE[V]	AC85 - 264 1 φ			
	CURRENT[A]	3.47typ (ACIN 100V)	2.86typ (ACIN 200V)	5.72typ (ACIN 100V)	4.24typ (ACIN 200V)
	FREQUENCY[Hz]	50/60 (47 - 63) Hz			
	INRUSH CURRENT[A]	Limited by external resistance			
	EFFICIENCY[%]	92typ (ACIN 100V)	95typ (ACIN 200V)	93typ (ACIN 100V)	96typ (ACIN 200V)
	POWER FACTOR	0.96typ (ACIN 100V)	0.93typ (ACIN 200V)	0.96typ (ACIN 100V)	0.93typ (ACIN 200V)
	LEAKAGE CURRENT[mA]	0.75 max (60Hz, According to IEC62368-1 and DEN-AN)			
OUTPUT	WATTAGE[W]	*1 300	500	500	750
	VOLTAGE[V]	*2 360			
	VOLTAGE ACCURACY	*3 ±2%			
PROTECTION CIRCUIT AND OTHERS	OVERVOLTAGE PROTECTION[V]	DC400 - 450V The power factor corrector function stops			
	ENA	*4	Enable signal, Open-drain output, Maximum sink current 10mA, Maximum allowance voltage 35V		
	OTHERS	*5	Parallel operation impossible , Thermal protection		
ISOLATION	INPUT-OUTPUT	Non isolated			
	INPUT, OUTPUT-FG	AC2,800V 1minute Cutoff current = 10mA, DC500V, 50MΩ min (20±15°C)			
ENVIRONMENT	OPERATING TEMP., HUMID. AND ALTITUDE	-40 to +100°C (On aluminum base plate), 20 - 95%RH (Non condensing) (Refer to "Derating") 3,000m (10,000feet) max			
	STORAGE TEMP., HUMID. AND ALTITUDE	-40 to +100°C, 20 - 95%RH (Non condensing), 9,000m (30,000feet) max			
	VIBRATION	10 - 55Hz, 49.0m/s ² (5G), 3minutes period, 60minutes each along X, Y and Z axis			
	IMPACT	196.1m/s ² (20G), 11ms, once each along X, Y and Z axis			
SAFETY	AGENCY APPROVALS	UL60950-1, C-UL, EN62368-1 Complies with DEN-AN and IEC62368-1			
	HARMONIC ATTENUATOR	Complies with IEC61000-3-2 *6			
OTHERS	CASE SIZE/WEIGHT	58.4 × 12.7 × 61mm [2.3 × 0.5 × 2.4 inches] (W × H × D) / 100g max			
	COOLING METHOD	Conduction cooling (e.g. heat radiation from the aluminum base plate to the attached heat sink)			

- *1 Refer to "Derating".
- *2 When the input voltage is more than 240V, the output voltage becomes the value proportional to the input voltage.
- *3 The value included the output setting and the line regulation, the load regulation and the temperature regulation. However, the input voltage is less than 240V.
- *4 Refer to the instruction Manual.
- *5 The thermal protection stops the power factor corrector function and the ENA signal.
- *6 Please contact us about class C.

External view

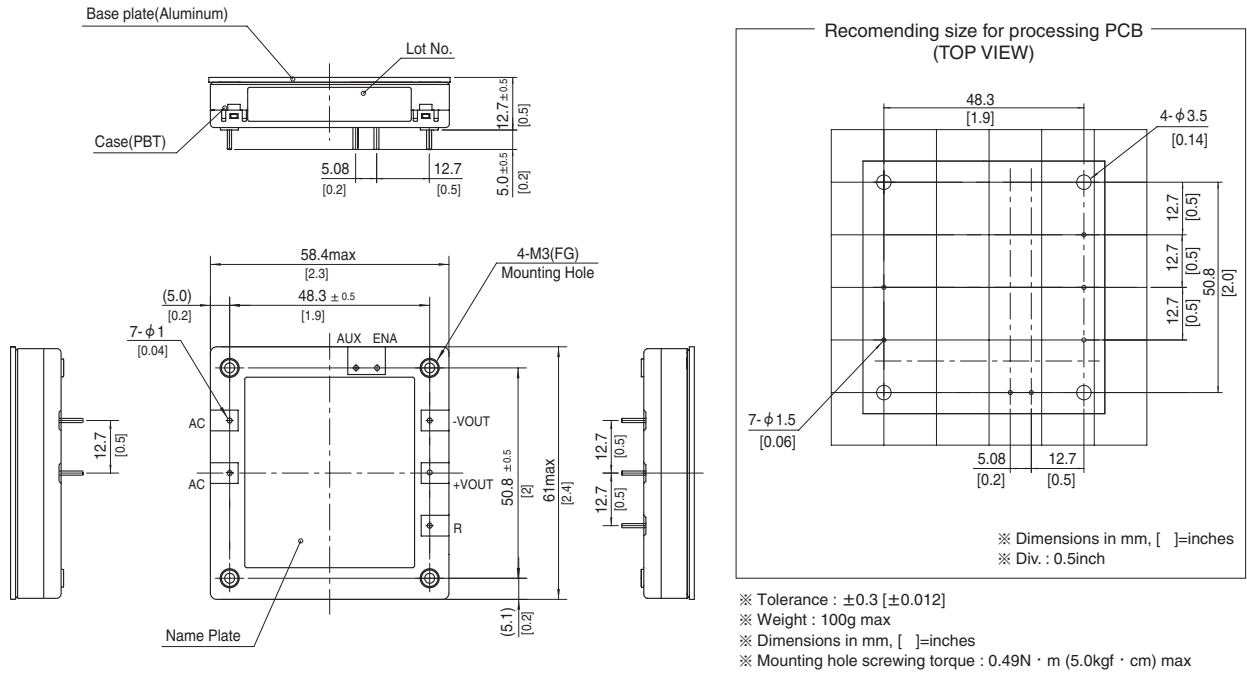

Performance data

■ STATIC CHARACTERISTICS (AC230V)

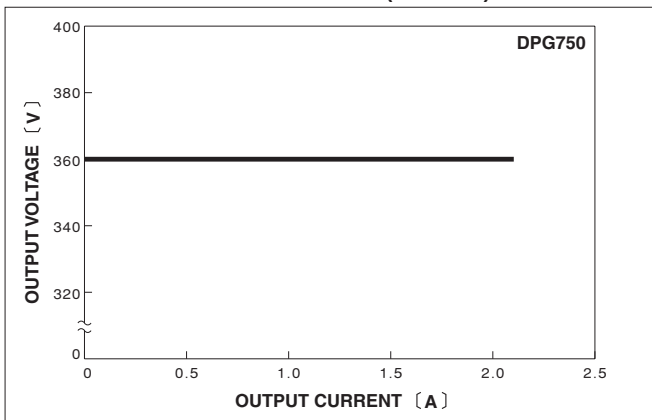

■ OUTPUT VOLTAGE FOR INPUT

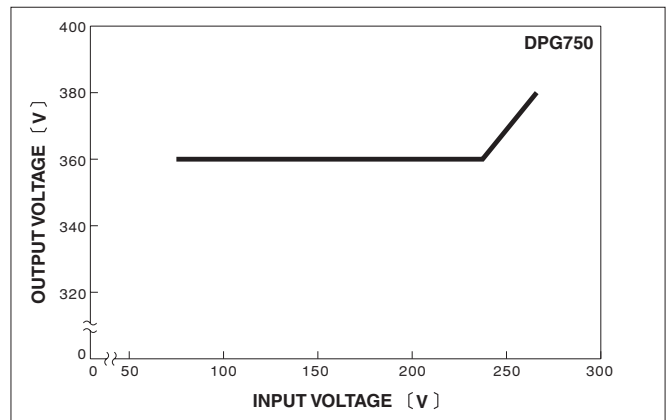

■ HARMONIC CURRENT (AC100V)

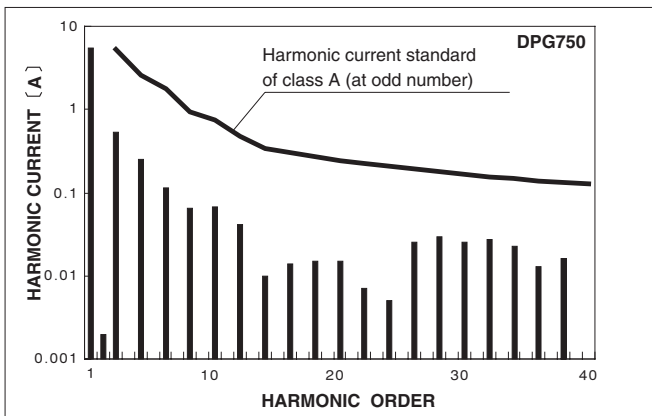

■ HARMONIC CURRENT (AC230V)

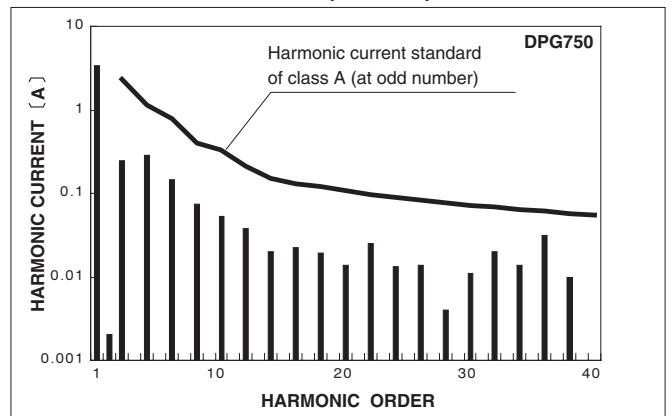

Pin Configuration

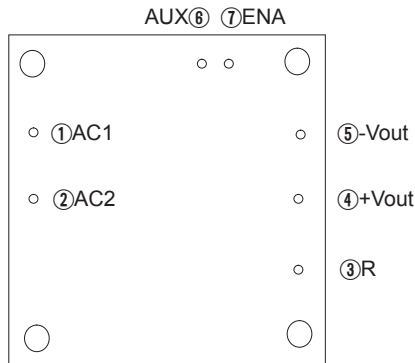

*Bottom View

No.	Pin Connection	Function
①	AC1	AC Input
②	AC2	
③	R	External resistor for inrush current protection
④	+VOUT	+DC output
⑤	-VOUT	-DC output
⑥	AUX	Auxiliary power supply for external signal
⑦	ENA	Enable signal

Implementation • Mounting Method

Mounting method

- The unit can be mounted in any direction. When two or more power supplies are used side by side, position them with proper intervals to allow enough air ventilation. Aluminum base plate temperature around each power supply should not exceed the temperature range shown in “Derating”.
- Avoid placing the AC input line pattern lay out underneath the unit, it will increase the line conducted noise. Make sure to leave an ample distance between the line pattern lay out and the unit. Also avoid placing the DC output line pattern of DC-DC converter underneath the unit because it may increase the output noise. Lay out the pattern away from the unit.
- High-frequency noise radiates directly from the unit to the atmosphere. Therefore, design the shield pattern on the printed circuit board and connect its one to FG. The shield pattern prevents noise radiation.

Stress onto the pins

- When too much stress is applied to the pins may damage internal connections. Avoid applying stress in excess of that shown in right figure.
- The pins are soldered onto the internal PCB. Therefore, Do not bend or pull the leads with excessive force.
- Mounting hole diameter of PCB should be 3.5mm to reduce the stress to the pins.
- Fix the unit on PCB (fixing fittings) by screws to reduce the stress to the pins. Be sure to mount the unit first, then solder the unit.

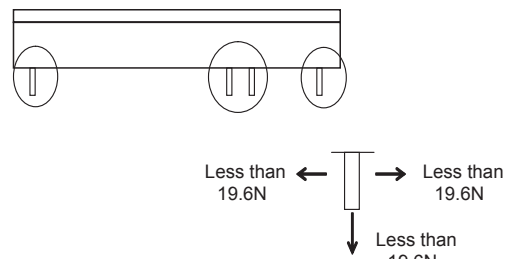

Soldering

- Flow soldering : 260°C less than 15 seconds.
- Soldering iron : 450°C less than 5 seconds.

Derating

Derating curve for input voltage

Below shows rated output for each input voltage section. Maximum output should be within this range.

● DPG500

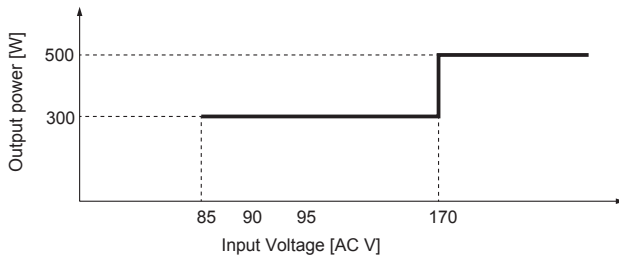

● DPG750

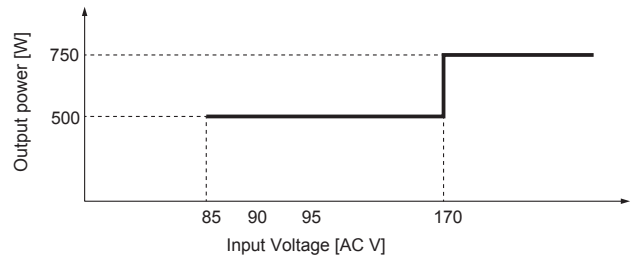

Output voltage derating curve

Use with the conduction cooling (e.g. heat radiation by conduction from the aluminum base plate to the attached heat sink). Below shows the derating curve based on the aluminum base plate temperature. In the hatched area, the specification of Ripple and Ripple Noise is different from other areas.

Please measure the temperature on the aluminum base plate edge side when you cannot measure the temperature of the center part of the aluminum base plate. In this case, please take 5deg temperature margin from the derating characteristic of Below.

It is necessary to note the thermal fatigue life by power cycle. Please reduce the temperature fluctuation range as much as possible when the up and down of the temperature are frequently generated. Contact us for more information on cooling methods.

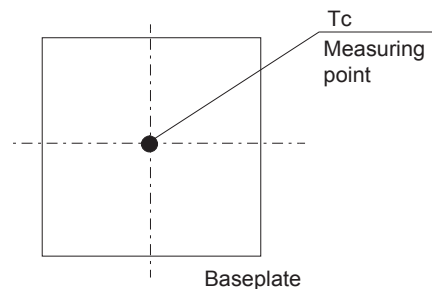
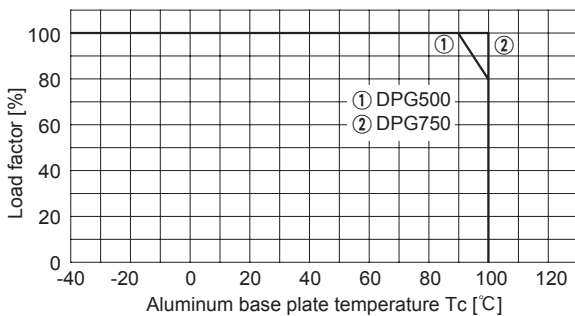

Instruction Manual

It is necessary to read the "Instruction Manual" and "Before using our product" before you use our product.

Instruction Manual <https://www.cosel.co.jp/redirect/catalog/en/DPG/>
 Before using our product <https://en.cosel.co.jp/technical/caution/index.html>



Basic Characteristics Data

Model	Circuit method	Switching frequency [kHz]	Inrush current protection	PCB/Pattern			Series/Parallel operation availability	
				Material	Single sided	Double sided	Series operation	Parallel operation
DPG500	Active filter	130	SCR	Aluminum	Yes		No	No
DPG750	Active filter	130	SCR	Aluminum	Yes		No	No