

# Data Sheet | Item Number: 2000-5317/101-000

3-conductor actuator supply terminal block; for NPN-(low-side) switching actuators; with ground contact; with colored conductor entries; 1 mm<sup>2</sup>; Push-in CAGE CLAMP®; 1,00 mm<sup>2</sup>; gray

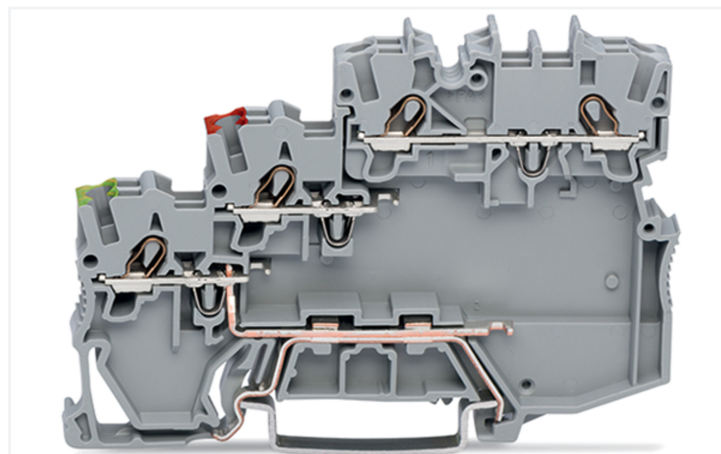

<https://www.wago.com/2000-5317/101-000>

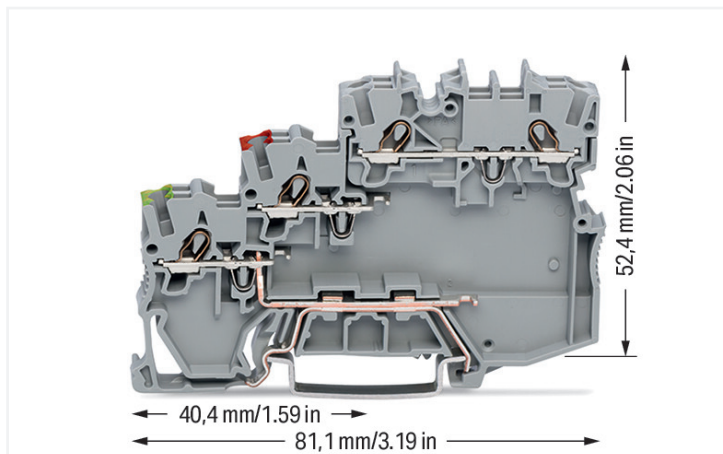

Color: ■ gray

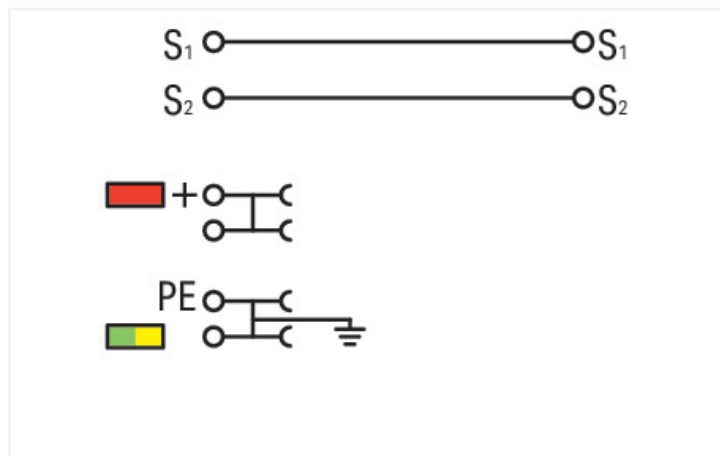
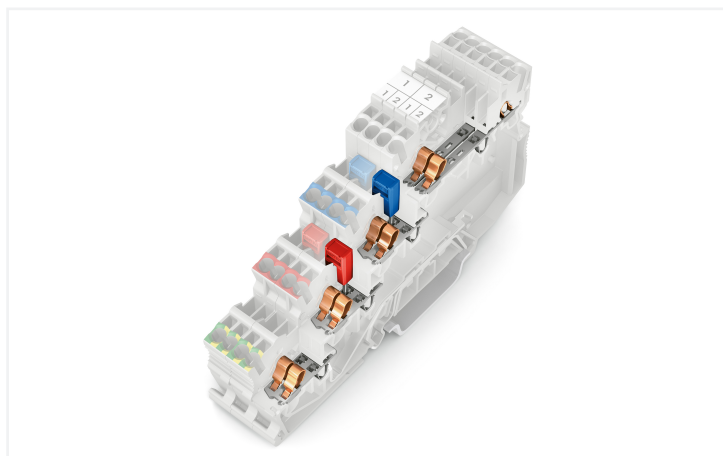

Similar to illustration

## Actuator terminal block, 2000 Series, gray

This actuator terminal block (item number 2000-5317/101-000) simplifies electrical installations. Ensure that the strip lengths are between 9 and 11 mm when connecting conductors to this actuator terminal block. This product features conductor terminals and utilizes Push-in CAGE CLAMP®. Push-in CAGE CLAMP® connection technology is ideal for connecting all conductor types. Both solid and fine-stranded conductors with ferrules can be pushed in without the need for tools—all thanks to its pluggable design. This actuator terminal block is suitable for conductor cross sections ranging from 0.14 mm<sup>2</sup> to 1.5 mm<sup>2</sup>.

### Electrical data

Ratings per	IEC/EN 60947-7-1		
Overvoltage category	III	III	II
Pollution degree	3	2	2
Nominal voltage	250 V	-	-
Rated impulse withstand voltage	4 kV	-	-
Rated current	13.5 A	-	-

Approvals per	UL 1059		
Use group	B	C	D
Rated voltage	300 V	-	300 V
Rated current	15 A	-	15 A

Approvals per	CSA 22.2 No 158		
Use group	B	C	D
Rated voltage	-	300 V	-
Rated current	-	10 A	-

Power Loss	
Power loss, per pole (potential)	0.4338 W
Rated current $I_N$ for power loss specification	13.5 A
Resistance value for specified, current-dependent power loss	0.00238 $\Omega$

General information	
LED (switching) for	NPN
Wiring direction	Front-entry wiring

## Connection Data

Clamping units	8
Total number of potentials	4
Number of levels	3
Number of jumper slots	4

Connection 1	
Connection technology	Push-in CAGE CLAMP®
Actuation type	Operating tool
Connectable conductor materials	Copper
Nominal cross-section	1 mm <sup>2</sup>
Solid conductor	0.14 ... 1.5 mm <sup>2</sup> / 24 ... 16 AWG
Solid conductor; push-in termination	0.5 ... 1.5 mm <sup>2</sup> / 20 ... 16 AWG
Fine-stranded conductor	0.14 ... 1.5 mm <sup>2</sup> / 24 ... 16 AWG
Fine-stranded conductor; with insulated ferrule	0.14 ... 0.75 mm <sup>2</sup> / 24 ... 18 AWG
Fine-stranded conductor; with ferrule; push-in termination	0.5 ... 0.75 mm <sup>2</sup> / 20 ... 18 AWG
Note (conductor cross-section)	Depending on the conductor characteristic, a conductor with a smaller cross-section can also be inserted via push-in termination.
Strip length	9 ... 11 mm / 0.35 ... 0.43 inches
Wiring direction	Front-entry wiring

## Physical data

Width	7 mm / 0.276 inches
Height	81.1 mm / 3.193 inches
Depth from upper-edge of DIN-rail	52.4 mm / 2.063 inches

## Mechanical data

Mounting type	DIN-35 rail
Marking level	Center/side marking

## Material data

Note (material data)	<a href="#">Information on material specifications can be found here</a>
Color	gray
Material group	I
Insulation material (main housing)	Polyamide (PA66)
Flammability class per UL94	V0
Fire load	0.317 MJ
Weight	17.4 g

## Environmental requirements

Processing temperature	-35 ... +85 °C
Continuous operating temperature	-60 ... +105 °C

## Environmental Testing

Test specification: Railway applications – Rolling stock – Electronic equipment	DIN EN 50155 (VDE 0115-200):2022-06
Test procedure: Railway applications – Rolling stock equipment – Vibration and shock tests	DIN EN 61373 (VDE 0115-0106):2011-04
Spectrum/Mounting location	Service life test, Category 1, Class A/B
Functional test with noise-like oscillations	Test passed according to Section 8 of the standard
Frequency	$f_1 = 5 \text{ Hz}$ to $f_2 = 150 \text{ Hz}$
Acceleration	0.101g (highest test level used for all axes)
Test duration per axis	10 min.
Test directions	X, Y and Z axes
Monitoring of contact faults and interruptions	Passed
Voltage drop measurement before and after each axis	Passed
Simulated service life test through increased levels of noise-like oscillations	Test passed according to Section 9 of the standard
Frequency	$f_1 = 5 \text{ Hz}$ to $f_2 = 150 \text{ Hz}$
Acceleration	0.572g (highest test level used for all axes)
Test duration per axis	5 h
Test directions	X, Y and Z axes
Extended testing: Monitoring of contact faults and interruptions	Passed
Extended testing: Voltage drop measurement before and after each axis	Passed
Shock test	Test passed according to Section 10 of the standard
Shock pulse form	Half sine
Acceleration	5g (highest test level used for all axes)
Shock duration	30 ms
Number of shocks (per axis)	3 pos. und 3 neg.
Test directions	X, Y and Z axes
Extended testing: Monitoring of contact faults and interruptions	Passed
Extended testing: Voltage drop measurement before and after each axis	Passed
Vibration and shock stress for rolling stock equipment	Passed

## Commercial data

PU (SPU)	50 pcs
Packaging type	Box
Country of origin	DE
GTIN	4055143408172
Customs tariff number	85369010000

**Product Classification**

UNSPSC	39121410
eCl@ss 10.0	27-14-11-28
eCl@ss 9.0	27-14-11-28
ETIM 9.0	EC000900
ETIM 10.0	EC000900
ECCN	NO US CLASSIFICATION

**Environmental Product Compliance**

RoHS Compliance Status	Compliant, No Exemption
------------------------	-------------------------

**Approvals / Certificates**

**Declarations of conformity and manufacturer's declarations**

Approval	Standard	Certificate Name
EU-Declaration of Conformity WAGO GmbH & Co. KG	-	-
UK-Declaration of Conformity WAGO GmbH & Co. KG	-	-

**Downloads**

**Environmental Product Compliance**

**Compliance Search**

Environmental Product Compliance 2000-5317/101-000	<a href="#">↓</a>
-------------------------------------------------------	-------------------

**Documentation**

**Bid Text**

2000-5317/101-000	07.08.2018	docx 15.16 KB	<a href="#">↓</a>
2000-5317/101-000	19.02.2019	xml 3.98 KB	<a href="#">↓</a>

**CAD/CAE-Data**

**CAD data**

2D/3D Models 2000-5317/101-000	<a href="#">↓</a>
-----------------------------------	-------------------

**CAE data**

EPLAN Data Portal 2000-5317/101-000	<a href="#">↓</a>
ZUKEN Portal 2000-5317/101-000	<a href="#">↓</a>

## 1 Compatible Products

### 1.1 Required Accessories

#### 1.1.1 End plate

##### 1.1.1.1 End plate



**Item No.: 2000-5391**

End and intermediate plate; 1 mm thick; for 3-conductor terminal blocks; gray

### 1.2 Optional Accessories

#### 1.2.1 DIN-rail

##### 1.2.1.1 Mounting accessories



**Item No.: 210-196**

Aluminum carrier rail; 35 x 8.2 mm; 1.6 mm thick; 2 m long; unslotted; similar to EN 60715; silver-colored



**Item No.: 210-198**

Copper carrier rail; 35 x 15 mm; 2.3 mm thick; 2 m long; unslotted; according to EN 60715; copper-colored



**Item No.: 210-197**

Steel carrier rail; 35 x 15 mm; 1.5 mm thick; 2 m long; slotted; similar to EN 60715; silver-colored



**Item No.: 210-114**

Steel carrier rail; 35 x 15 mm; 1.5 mm thick; 2 m long; unslotted; similar to EN 60715; silver-colored



**Item No.: 210-118**

Steel carrier rail; 35 x 15 mm; 2.3 mm thick; 2 m long; unslotted; according to EN 60715; silver-colored



**Item No.: 210-115**

Steel carrier rail; 35 x 7.5 mm; 1 mm thick; 2 m long; slotted; according to EN 60715; "Hole width 18 mm; silver-colored



**Item No.: 210-112**

Steel carrier rail; 35 x 7.5 mm; 1 mm thick; 2 m long; slotted; according to EN 60715; "Hole width 25 mm; silver-colored



**Item No.: 210-113**

Steel carrier rail; 35 x 7.5 mm; 1 mm thick; 2 m long; unslotted; according to EN 60715; silver-colored

### 1.2.2 Ferrule

#### 1.2.2.1 Ferrule



**Item No.: 216-241**

Ferrule; Sleeve for 0.5 mm<sup>2</sup> / 20 AWG; insulated; electro-tin plated; electrolytic copper; gastight crimped; acc. to DIN 46228, Part 4/09.90; white



**Item No.: 216-242**

Ferrule; Sleeve for 0.75 mm<sup>2</sup> / 18 AWG; insulated; electro-tin plated; electrolytic copper; gastight crimped; acc. to DIN 46228, Part 4/09.90; gray



**Item No.: 216-243**

Ferrule; Sleeve for 1 mm<sup>2</sup> / AWG 18; insulated; electro-tin plated; electrolytic copper; gastight crimped; acc. to DIN 46228, Part 4/09.90; red

### 1.2.3 Installation

#### 1.2.3.1 Cover



**Item No.: 709-156**

Cover; Type 3; suitable for cover carrier, type 3; 1 m long; transparent

1.2.3.2 Cover carrier



**Item No.: 709-169**

Cover carrier; Type 3; incl. fixing/retaining screws and knurled nut; suitable for 279 to 282 and 880 Series rail-mounted terminal blocks; suitable for 264 Series miniature rail-mounted terminal blocks; suitable for 270 Series sensor and actuator terminal blocks; gray

1.2.4 Jumper

1.2.4.1 Jumper



**Item No.: 2000-406/020-000**

Delta jumper; insulated; light gray



**Item No.: 2000-410/000-006**

Jumper; 10-way; insulated; blue



**Item No.: 2000-410**

Jumper; 10-way; insulated; light gray



**Item No.: 2000-410/000-005**

Jumper; 10-way; insulated; red



**Item No.: 2000-402/000-006**

Jumper; 2-way; insulated; blue



**Item No.: 2000-402**

Jumper; 2-way; insulated; light gray



**Item No.: 2000-402/000-005**

Jumper; 2-way; insulated; red



**Item No.: 2000-402/000-018**

Jumper; 2-way; insulated; yellow-green



**Item No.: 2000-403/000-006**

Jumper; 3-way; insulated; blue



**Item No.: 2000-403**

Jumper; 3-way; insulated; light gray



**Item No.: 2000-403/000-005**

Jumper; 3-way; insulated; red



**Item No.: 2000-404/000-006**

Jumper; 4-way; insulated; blue



**Item No.: 2000-404**

Jumper; 4-way; insulated; light gray



**Item No.: 2000-404/000-005**

Jumper; 4-way; insulated; red



**Item No.: 2000-405/000-006**

Jumper; 5-way; insulated; blue



**Item No.: 2000-405**

Jumper; 5-way; insulated; light gray



**Item No.: 2000-405/000-005**

Jumper; 5-way; insulated; red



**Item No.: 2000-406/000-006**

Jumper; 6-way; insulated; blue



**Item No.: 2000-406**

Jumper; 6-way; insulated; light gray



**Item No.: 2000-406/000-005**

Jumper; 6-way; insulated; red



**Item No.: 2000-407/000-006**

Jumper; 7-way; insulated; blue



**Item No.: 2000-407**

Jumper; 7-way; insulated; light gray



**Item No.: 2000-407/000-005**

Jumper; 7-way; insulated; red



**Item No.: 2000-408/000-006**

Jumper; 8-way; insulated; blue



**Item No.: 2000-408**

Jumper; 8-way; insulated; light gray



**Item No.: 2000-408/000-005**

Jumper; 8-way; insulated; red



**Item No.: 2000-409/000-006**

Jumper; 9-way; insulated; blue



**Item No.: 2000-409**

Jumper; 9-way; insulated; light gray



**Item No.: 2000-409/000-005**

Jumper; 9-way; insulated; red



**Item No.: 2000-440**

Jumper; from 1 to 10; insulated; light gray



**Item No.: 2000-433/000-006**

Jumper; from 1 to 3; insulated; blue



**Item No.: 2000-433**

Jumper; from 1 to 3; insulated; light gray



**Item No.: 2000-433/000-005**

Jumper; from 1 to 3; insulated; red



**Item No.: 2000-434**

Jumper; from 1 to 4; insulated; light gray



**Item No.: 2000-435**

Jumper; from 1 to 5; insulated; light gray



**Item No.: 2000-436**

Jumper; from 1 to 6; insulated; light gray



**Item No.: 2000-437**

Jumper; from 1 to 7; insulated; light gray



**Item No.: 2000-438**

Jumper; from 1 to 8; insulated; light gray



**Item No.: 2000-439**

Jumper; from 1 to 9; insulated; light gray



**Item No.: 2000-405/011-000**

Star point jumper; 3-way; insulated; light gray



**Item No.: 210-103**

Wire commoning chain; insulated; black



**Item No.: 210-123**

Wire commoning chain; insulated; blue

### 1.2.5 Marking

#### 1.2.5.1 Group marker carrier



**Item No.: 2009-191**

Group marker carrier; gray

#### 1.2.5.2 Marker



**Item No.: 793-3501**

WMB marking card; as card; plain; snap-on type; white



**Item No.: 2009-113/000-006**

WMB-Inline; for Smart Printer; 2300 pieces on roll; plain; snap-on type; blue



**Item No.: 2009-113/000-007**

WMB-Inline; for Smart Printer; 2300 pieces on roll; plain; snap-on type; gray



**Item No.: 2009-113/000-023**

WMB-Inline; for Smart Printer; 2300 pieces on roll; plain; snap-on type; green



**Item No.: 2009-113/000-017**

WMB-Inline; for Smart Printer; 2300 pieces on roll; plain; snap-on type; light green



**Item No.: 2009-113/000-012**

WMB-Inline; for Smart Printer; 2300 pieces on roll; plain; snap-on type; orange



**Item No.: 2009-113/000-005**

WMB-Inline; for Smart Printer; 2300 pieces on roll; plain; snap-on type; red



**Item No.: 2009-113/000-024**

WMB-Inline; for Smart Printer; 2300 pieces on roll; plain; snap-on type; violet



**Item No.: 2009-113**

WMB-Inline; for Smart Printer; 2300 pieces on roll; plain; snap-on type; white



**Item No.: 2009-113/000-002**

WMB-Inline; for Smart Printer; 2300 pieces on roll; plain; snap-on type; yellow

#### 1.2.5.3 Marker carrier



**Item No.: 2000-121**

Adaptor; gray

#### 1.2.5.4 Marking strip



**Item No.: 2009-110**

Marking strips; for Smart Printer; on reel; not stretchable; plain; snap-on type; white

### 1.2.6 Protective warning marker

#### 1.2.6.1 Cover



**Item No.: 2000-115**

Protective warning marker; for 5 terminal blocks; with high-voltage symbol, black; yellow

## 1.2.7 Push-in type wire jumper

### 1.2.7.1 Jumper



**Item No.: 2009-404**

Push-in type wire jumper; 0.75 mm<sup>2</sup>; insulated; 110 mm long; gray



**Item No.: 2009-406**

Push-in type wire jumper; 0.75 mm<sup>2</sup>; insulated; 250 mm long; gray



**Item No.: 2009-402**

Push-in type wire jumper; 0.75 mm<sup>2</sup>; insulated; 60 mm long; gray

## 1.2.8 Screwless end stop

### 1.2.8.1 Mounting accessories



**Item No.: 249-117**

Screwless end stop; 10 mm wide; for DIN-rail 35 x 15 and 35 x 7.5; gray



**Item No.: 249-116**

Screwless end stop; 6 mm wide; for DIN-rail 35 x 15 and 35 x 7.5; gray

## 1.2.9 Test and measurement

### 1.2.9.1 Testing accessories



**Item No.: 2009-174**

Test plug adapter; for 4 mm Ø test plugs; for testing TOPJOB®S rail-mounted terminal blocks; gray



**Item No.: 2009-182**

Testing tap; for max. 2.5 mm<sup>2</sup>; tool-free connection for individual test wires 0.08 - 2.5 mm; gray

## 1.2.10 Tool

### 1.2.10.1 Operating tool



**Item No.: 210-719**

Operating tool; Blade: 2.5 x 0.4 mm; with a partially insulated shaft



**Item No.: 210-648**

Operating tool; Blade: 2.5 x 0.4 mm; with a partially insulated shaft; angled; short



**Item No.: 210-647**

Operating tool; Blade: 2.5 x 0.4 mm; with a partially insulated shaft; multicoloured

## Installation Notes

### Conductor termination



#### All conductor types at a glance

**Commoning**

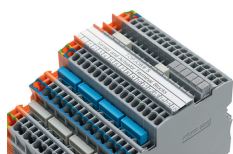

**Commoning (signal level):**  
Commoning the signal level with push-in type jumper bars (2000 Series). Models with an LED can only be commoned in one jumper slot!  
TOPJOB® S Test Plug Adapters can be used in all jumper slots.



**Upper level:** Two independent signal pathways

**Commoning**

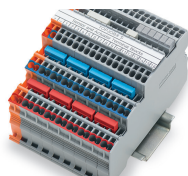

**Commoning (potential level):**  
Commoning potential levels via push-in type jumper bars (2000 Series).

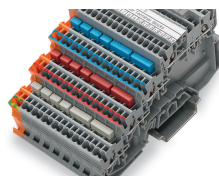

**Commoning (potential level):**  
Continuous commoning in the potential levels via push-in type jumper bars for even pole numbers (2000 Series)



**Potential levels:** Two adjacent commoning options on a current bar

**Commoning**

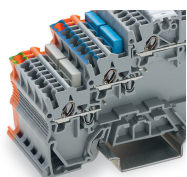

**Ground commoning:**  
For sensor and actuator terminal blocks without ground connection to the DIN-rail, the ground connection can be performed by commoning to the terminal block with a ground foot.

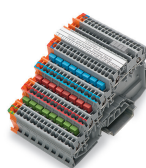

For example, colored push-in type jumper bars are used with sensor terminal blocks.

**Testing**

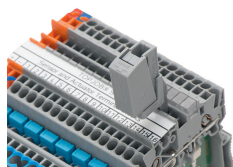

Testing via testing tap (2009-182) (up to max. 42 V).

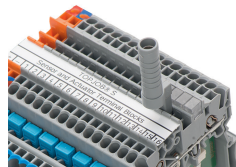

Testing via testing tap (2009-174) (up to max. 42 V).

**Application**

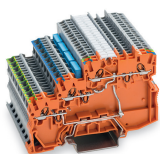

**Supply:**  
Orange supply terminal block of same profile with a power supply option from both the cabinet and sensor sides

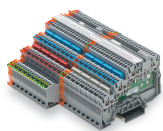

Terminal block assembly with 4-conductor sensor terminal blocks and 3-conductor actuator terminal blocks

## Marking

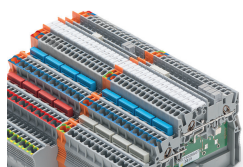

**Marking:**  
3.5 mm WMB markers (793-35xx) from the top or the side – additional marking option via marker carrier

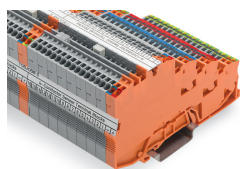

**Marking:**  
Labeling via marking strips (2009-110) – from the top or the side.