

ICS50-B100X98-V-V-7035 - Mounting base housing



1076998

<https://www.phoenixcontact.com/us/products/1076998>

Please be informed that the data shown in this PDF document is generated from our online catalog. Please find the complete data in the user documentation. Our general terms of use for downloads are valid.



DIN rail housing, Lower housing part with metal foot catch, Level 1: with vents, width: 50.1 mm, height: 100 mm, depth: 108.35 mm, color: light grey (similar RAL 7035), cross connection: DIN rail connector (optional), number of positions cross connector: 8

Your advantages

- Flexible use, thanks to the modular system and unique modularity in the connection technology
- Standardized connections such as RJ45, USB, D-SUB and antenna sockets as components that can be integrated
- Optimal space utilization, as well as adaptability of design, colors, and printing
- Eight-position DIN rail connectors with parallel and up to two serial contacts for easy module-to-module communication

Commercial data

Item number	1076998
Packing unit	5 pc
Minimum order quantity	5 pc
Sales key	AC09
Product key	ACHAEB
GTIN	4055626785882
Weight per piece (including packing)	68.72 g
Weight per piece (excluding packing)	48.7 g
Customs tariff number	85472000
Country of origin	DE

ICS50-B100X98-V-V-7035 - Mounting base housing



1076998

<https://www.phoenixcontact.com/us/products/1076998>

Technical data

Notes

Assembly note	Refer to the data sheet for the range in the download area.
Recommendation	Material of contact pads for bus connector, galvanic gold (hard gold)

Product properties

Product type	Enclosure bottom part
Housing type	DIN rail housing
Housing series	ICS
Product family	ICS50-..100X..
Max. number of positions	60 (pitch: 3.5 mm) 48 (pitch: 5 mm)
Number of rows	4
Type	Lower housing part with metal foot catch
Ventilation openings present	yes

Dimensions

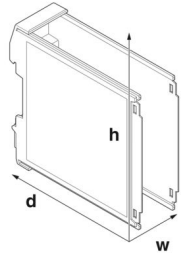
Dimensional drawing	
Width	50.1 mm
Height	100 mm
Depth	108.35 mm
Depth from top edge of DIN rail to support point on upper part	98.15 mm
Dimensions	50.1 mm x 100 mm x 110 mm (Lower housing part from the top edge of the DIN rail with upper housing part) 50.1 mm x 100 mm x 116.7 mm (Lower housing part with upper housing part)

PCB design

PCB thickness	1.4 mm ... 1.8 mm
---------------	-------------------

Material specifications

Color (Housing)	light grey (RAL 7035)
Flammability rating according to UL 94	V0
CTI according to IEC 60112	600
Housing material	Polyamide
Surface characteristics	untreated

ICS50-B100X98-V-V-7035 - Mounting base housing



1076998

<https://www.phoenixcontact.com/us/products/1076998>

Environmental and real-life conditions

Vibration test

Specification	IEC 60068-2-6:2007-12
Frequency	10 - 150 - 10 Hz
Sweep speed	1 octave/min
Amplitude	0.15 mm (10 Hz ... 58.1 Hz)
Acceleration	2g (58.1 Hz ... 150 Hz)
Test duration per axis	2.5 h
Test directions	X-, Y- and Z-axis

Glow-wire test

Specification	IEC 60695-2-11:2014-02
Temperature	850 °C
Time of exposure	30 s

Thermal stability / ball thrust test

Specification	IEC 60695-10-2:2014-02
Temperature	125 °C
Test duration	1 h
Force	20 N

Mechanical strength / tumbling barrel

Specification	IEC 60068-2-31:2008-05
Height of fall	50 cm
Frequency	50

Shocks

Specification	IEC 60068-2-27:2008-02
Pulse shape	Semi-sinusoidal
Acceleration	15g
Shock duration	11 ms
Number of shocks per direction	3
Test directions	X-, Y- and Z-axis (pos. and neg.)

Test for substances that would hinder coating with paint or varnish

Specification	VDMA 24364:2018-05
Result	Test passed

Degree of protection (IP code)

Specification	IEC 60529:1989-11 + AMD 1:1999-11 + AMD 2:2013-08
Result, degree of protection, IP code	IP20

Ambient conditions

Max. IP code to attain	IP20
Ambient temperature (operation)	-40 °C ... 105 °C (depending on power dissipation)
Ambient temperature (storage/transport)	-40 °C ... 55 °C

ICS50-B100X98-V-V-7035 - Mounting base housing



1076998

<https://www.phoenixcontact.com/us/products/1076998>

Ambient temperature (assembly)	-5 °C ... 100 °C
Relative humidity (storage/transport)	80 %

PCB data

Number of PCB holders	4
Type of PCB mount	Latching
Thickness of the PCB	1.4 mm ... 1.8 mm

Mounting

Mounting type	DIN rail mounting
Mounting position	Vertical (horizontal DIN rail)

Packaging specifications

Type of packaging	packed in cardboard
Outer packaging type	Carton

ICS50-B100X98-V-V-7035 - Mounting base housing



1076998

<https://www.phoenixcontact.com/us/products/1076998>

Drawings

Dimensional drawing



Schematic figure for illustrating the item dimensions. The figure is not of the desired product. For further details, refer to the product drawings in the "Downloads" tab.

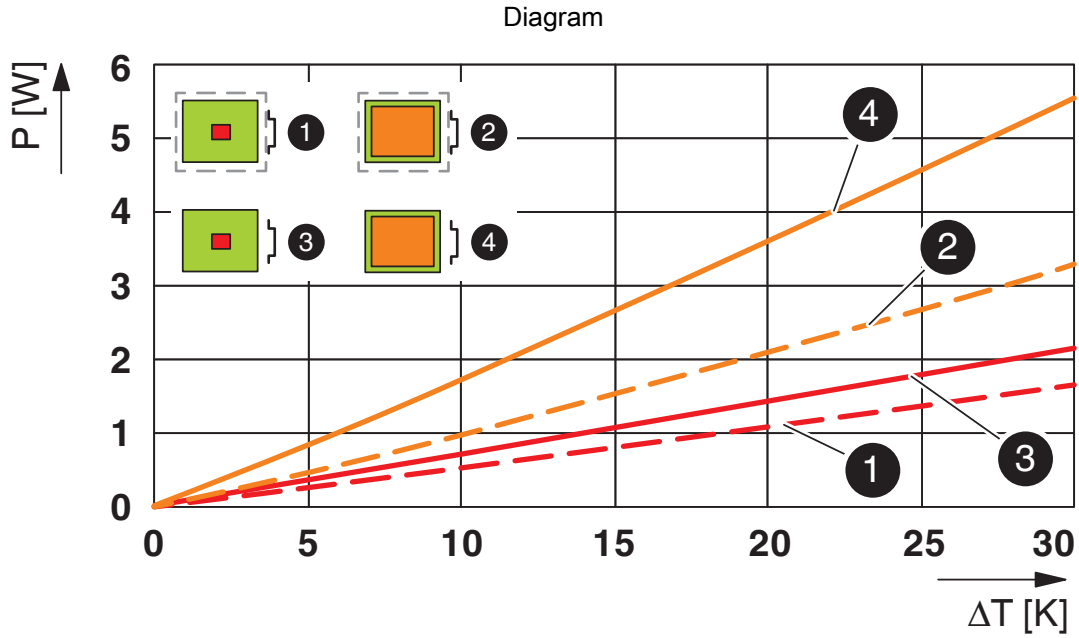

Power dissipation diagram for 0 K ... 30 K

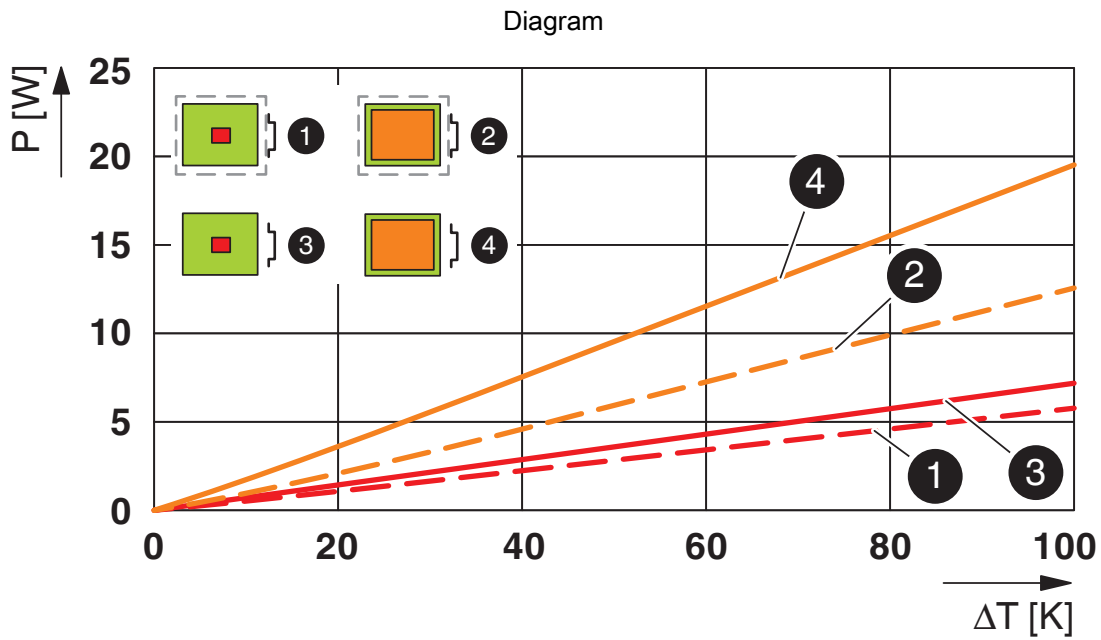

Power dissipation diagram for 0 K ... 100 K

ICS50-B100X98-V-V-7035 - Mounting base housing



1076998

<https://www.phoenixcontact.com/us/products/1076998>

Classifications

ECLASS

ECLASS-11.0	27182702
ECLASS-13.0	27190601

ETIM

ETIM 9.0	EC002779
----------	----------

UNSPSC

UNSPSC 21.0	31261500
-------------	----------

ICS50-B100X98-V-V-7035 - Mounting base housing



1076998

<https://www.phoenixcontact.com/us/products/1076998>

Environmental product compliance

EU RoHS

Fulfills EU RoHS substance requirements	Yes, No exemptions
---	--------------------

China RoHS

Environment friendly use period (EFUP)	EFUP-E
	No hazardous substances above the limits

EU REACH SVHC

REACH candidate substance (CAS No.)	No substance above 0.1 wt%
-------------------------------------	----------------------------

ICS50-B100X98-V-V-7035 - Mounting base housing



1076998

<https://www.phoenixcontact.com/us/products/1076998>

Mandatory accessories

ICS50-C100X12-7035 - Upper housing part

1076995

<https://www.phoenixcontact.com/us/products/1076995>

DIN rail housing, Upper part, closed, width: 50.1 mm, height: 100 mm, depth: 14.35 mm, color: light grey (similar RAL 7035)



ICS50-C100X12-D2,4-TRG-7035 - Upper housing part with touch display

1077656

<https://www.phoenixcontact.com/us/products/1077656>

DIN rail housing, Upper part, integrated 2.4" resistive touch display, resolution: 320 x 240 Pixel(s), interface: 4-wire SPI half duplex, width: 50.1 mm, height: 100 mm, depth: 14.35 mm



ICS50-B100X98-V-V-7035 - Mounting base housing



1076998

<https://www.phoenixcontact.com/us/products/1076998>

ICS50-C100X12-D2,4-TRG-7035-VPE1 - Upper housing part with touch display

1226370

<https://www.phoenixcontact.com/us/products/1226370>

DIN rail housing, Upper part, integrated 2.4" resistive touch display, resolution: 320 x 240 Pixel(s), interface: 4-wire SPI half duplex, width: 50.1 mm, height: 100 mm, depth: 14.35 mm



ICS50-TL100X12-7035 - Upper housing part

1076994

<https://www.phoenixcontact.com/us/products/1076994>

DIN rail housing, Upper part, with transparent hinged cover, width: 50.1 mm, height: 101 mm, depth: 14.35 mm, color: light grey (similar RAL 7035)



Accessories

ICS50-B100X98-V-V-7035 - Mounting base housing

1076998

<https://www.phoenixcontact.com/us/products/1076998>



ICS-FE-CONTACT - Functional ground contact

2203904

<https://www.phoenixcontact.com/us/products/2203904>

Functional ground contact, for ICS series electronics housings



ICC25-H/4L5,0-7035 - PCB header

2203902

<https://www.phoenixcontact.com/us/products/2203902>



PCB headers, nominal cross section: 2.5 mm², color: light grey, nominal current: 16 A, rated voltage (III/2): 320 V, contact connection type: Pin, number of potentials: 4, number of rows: 1, number of positions: 4, number of connections: 4, product range: ICC..-H/..L5,0, pitch: 5 mm, mounting: Wave soldering, pin layout: Linear pinning, solder pin [P]: 3.5 mm, number of solder pins per potential: 1, Pin connector pattern alignment: Standard, locking: Snap-in locking, mounting: without, type of packaging: Box packaging, Product with pin output on left side

ICS50-B100X98-V-V-7035 - Mounting base housing



1076998

<https://www.phoenixcontact.com/us/products/1076998>

ICC25-H/4R5,0-7035 - PCB header

2203903

<https://www.phoenixcontact.com/us/products/2203903>



PCB headers, nominal cross section: 2.5 mm², color: light grey, nominal current: 16 A, rated voltage (III/2): 320 V, contact connection type: Pin, number of potentials: 4, number of rows: 1, number of positions: 4, number of connections: 4, product range: ICC...-H/..R5,0, pitch: 5 mm, mounting: Wave soldering, pin layout: Linear pinning, solder pin [P]: 3.5 mm, number of solder pins per potential: 1, Pin connector pattern alignment: Standard, locking: Snap-in locking, mounting: without, type of packaging: Box packaging, Product with pin output on right side

ICC25-H/5L3,5-7035 - PCB header

1084018

<https://www.phoenixcontact.com/us/products/1084018>



PCB headers, color: light grey, nominal current: 8 A, rated voltage (III/2): 150 V, contact surface: Tin, contact connection type: Pin, number of potentials: 5, number of rows: 1, number of positions: 5, number of connections: 5, product range: ICC...-H/..L3,5, pitch: 3.5 mm, mounting: Wave soldering, pin layout: Linear pinning, solder pin [P]: 2.8 mm, number of solder pins per potential: 1, Pin connector pattern alignment: Standard, locking: Snap-in locking, mounting: without, type of packaging: Box packaging, Product with pin output on left side

ICS50-B100X98-V-V-7035 - Mounting base housing



1076998

<https://www.phoenixcontact.com/us/products/1076998>

ICC25-H/5R3,5-7035 - PCB header

1084017

<https://www.phoenixcontact.com/us/products/1084017>

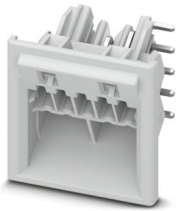

PCB headers, color: light grey, nominal current: 8 A, rated voltage (III/2): 150 V, contact surface: Tin, contact connection type: Pin, number of potentials: 5, number of rows: 1, number of positions: 5, number of connections: 5, product range: ICC..-H/..R3,5, pitch: 3.5 mm, mounting: Wave soldering, pin layout: Linear pinning, solder pin [P]: 2.8 mm, number of solder pins per potential: 1, Pin connector pattern alignment: Standard, locking: Snap-in locking, mounting: without, type of packaging: Box packaging, Product with pin output on right side

ICE25-F22H-A1 - Heatsink

1328704

<https://www.phoenixcontact.com/us/products/1328704>

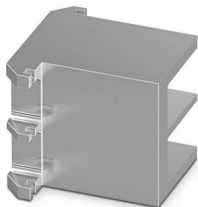

Heatsink for housing series: ICS, type: Heatsink fillers, material: Aluminum, anodized, product range: ICS25, width: 22.4 mm, height: 25 mm, Individual milling possible.

ICS50-B100X98-V-V-7035 - Mounting base housing



1076998

<https://www.phoenixcontact.com/us/products/1076998>

ICE25-F45H-A1 - Heatsink

1328703

<https://www.phoenixcontact.com/us/products/1328703>

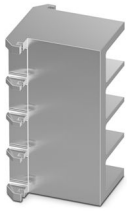

Heatsink for housing series: ICS, type: Heatsink fillers, material: Aluminum, anodized, product range: ICS25, width: 44.9 mm, height: 25 mm, Individual milling possible.

ICE25-R100X22-A1 - Heatsink

1328715

<https://www.phoenixcontact.com/us/products/1328715>



Heatsink for housing series: ICS, material: Aluminum, anodized, product range: ICS25-..100X.., width: 22.4 mm, height: 25 mm, Individual milling possible.

ICS50-B100X98-V-V-7035 - Mounting base housing



1076998

<https://www.phoenixcontact.com/us/products/1076998>

ICE25-R100X45-A1 - Heatsink

1328714

<https://www.phoenixcontact.com/us/products/1328714>

Heatsink for housing series: ICS, material: Aluminum, anodized, product range: ICS25-..100X.., width: 44.9 mm, height: 25 mm, Individual milling possible.



ICE50-R100X22-A1 - Heatsink

1328713

<https://www.phoenixcontact.com/us/products/1328713>

Heatsink for housing series: ICS, material: Aluminum, anodized, product range: ICS50-..100X.., width: 22.4 mm, height: 50.1 mm, Individual milling possible.



ICS50-B100X98-V-V-7035 - Mounting base housing



1076998

<https://www.phoenixcontact.com/us/products/1076998>

ICE50-R100X45-A1 - Heatsink

1328712

<https://www.phoenixcontact.com/us/products/1328712>

Heatsink for housing series: ICS, material: Aluminum, anodized, product range: ICS50-..100X.., width: 44.9 mm, height: 50.1 mm, Individual milling possible.



ICE50-R100X67-A1 - Heatsink

1118306

<https://www.phoenixcontact.com/us/products/1118306>

Heatsink for housing series: ICS, material: Aluminum, anodized, product range: ICS50-..100X.., width: 67.4 mm, height: 50.1 mm, Individual milling possible.

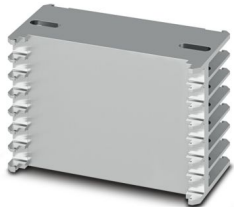

ICS50-B100X98-V-V-7035 - Mounting base housing



1076998

<https://www.phoenixcontact.com/us/products/1076998>

ICS25-F22A6-7035 - Connection plate

1287369

<https://www.phoenixcontact.com/us/products/1287369>

DIN rail housing, ICS filler, with antenna function cutout, width: 25 mm, height: 7.25 mm, depth: 22.4 mm, color: light grey (similar RAL 7035)



ICS25-F22A-7035 - Connection plate

2203894

<https://www.phoenixcontact.com/us/products/2203894>

DIN rail housing, ICS filler, with antenna function cutout, width: 25 mm, height: 7.25 mm, depth: 22.4 mm, color: light grey (similar RAL 7035)



ICS50-B100X98-V-V-7035 - Mounting base housing

1076998

<https://www.phoenixcontact.com/us/products/1076998>



ICS25-F22J-7035 - Connection plate

2203895

<https://www.phoenixcontact.com/us/products/2203895>

DIN rail housing, ICS filler, with RJ45 function cutout, width: 25 mm, height: 7.25 mm, depth: 22.4 mm, color: light grey (similar RAL 7035)



ICS25-F22S-7035 - Connection plate

2203890

<https://www.phoenixcontact.com/us/products/2203890>

DIN rail housing, ICS filler, closed, width: 25 mm, height: 7.25 mm, depth: 22.4 mm, color: light grey (similar RAL 7035)



ICS50-B100X98-V-V-7035 - Mounting base housing



1076998

<https://www.phoenixcontact.com/us/products/1076998>

ICS25-F22U-7035 - Connection plate

1053046

<https://www.phoenixcontact.com/us/products/1053046>

DIN rail housing, ICS filler, with USB function cutout, width: 25 mm, height: 7.25 mm, depth: 22.4 mm, color: light grey (similar RAL 7035)



ICS25-F22V-7035 - Connection plate

1079495

<https://www.phoenixcontact.com/us/products/1079495>

DIN rail housing, ICS filler, with vents, width: 25 mm, height: 7.25 mm, depth: 22.4 mm, color: light grey (similar RAL 7035)



ICS50-B100X98-V-V-7035 - Mounting base housing



1076998

<https://www.phoenixcontact.com/us/products/1076998>

ICS25-F45D15-7035 - Connection plate

2203896

<https://www.phoenixcontact.com/us/products/2203896>

DIN rail housing, ICS filler, with D-SUB 15 function cutout, width: 25 mm, height: 7.25 mm, depth: 44.9 mm, color: light grey (similar RAL 7035)



ICS25-F45D9-7035 - Connection plate

1053054

<https://www.phoenixcontact.com/us/products/1053054>

DIN rail housing, ICS filler, with D-SUB 9 function cutout, width: 25 mm, height: 7.25 mm, depth: 44.9 mm, color: light grey (similar RAL 7035)

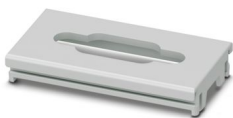

ICS50-B100X98-V-V-7035 - Mounting base housing

1076998

<https://www.phoenixcontact.com/us/products/1076998>



ICS25-F45S-7035 - Connection plate

2203891

<https://www.phoenixcontact.com/us/products/2203891>

DIN rail housing, ICS filler, closed, width: 25 mm, height: 7.25 mm, depth: 44.9 mm, color: light grey (similar RAL 7035)



ICS25-F45V-7035 - Connection plate

1079492

<https://www.phoenixcontact.com/us/products/1079492>

DIN rail housing, ICS filler, with vents, width: 25 mm, height: 7.25 mm, depth: 44.9 mm, color: light grey (similar RAL 7035)



ICS50-B100X98-V-V-7035 - Mounting base housing



1076998

<https://www.phoenixcontact.com/us/products/1076998>

ICS25-F67S-7035 - Connection plate

1287434

<https://www.phoenixcontact.com/us/products/1287434>

DIN rail housing, ICS filler, closed, width: 25 mm, height: 7.25 mm, depth: 67.3 mm, color: light grey (similar RAL 7035)



ICS25-F67V-7035 - Connection plate

1287409

<https://www.phoenixcontact.com/us/products/1287409>

DIN rail housing, ICS filler, with vents, width: 25 mm, height: 7.25 mm, depth: 67.3 mm, color: light grey (similar RAL 7035)



ICS50-B100X98-V-V-7035 - Mounting base housing



1076998

<https://www.phoenixcontact.com/us/products/1076998>

ICS MOUNTING DEVICE - Assembly tool

1118354

<https://www.phoenixcontact.com/us/products/1118354>

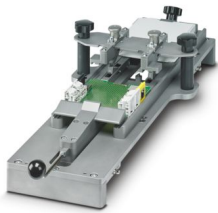

Equipment for fast, serial-production attachment of printed circuit boards in ICS 20 and ICS 25 housings

TBUS8-25,0-PPPPPPPP-7035 - DIN rail bus connectors

2202891

<https://www.phoenixcontact.com/us/products/2202891>

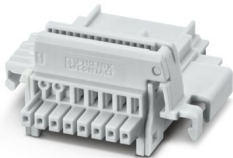

DIN rail connector, color: light grey, nominal current: 6 A (parallel contacts), rated voltage (III/2): 32 V, number of positions: 8, product range: TBUS8-25..., pitch: 2.54 mm, mounting: DIN rail mounting, locking: without, mounting: without, type of packaging: packed in cardboard, Item with gold-plated contacts, bus connectors for connecting with electronics housings, 8 parallel contacts

ICS50-B100X98-V-V-7035 - Mounting base housing



1076998

<https://www.phoenixcontact.com/us/products/1076998>

TBUS8-25,0-PPPPPPPS-7035 - DIN rail bus connectors

2202890

<https://www.phoenixcontact.com/us/products/2202890>

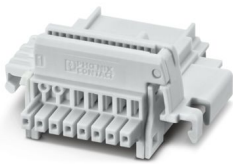

DIN rail connector, color: light grey, nominal current: 6 A, 4 A (parallel contacts) (Serial contacts), rated voltage (III/2): 32 V, number of positions: 8, product range: TBUS8-25..., pitch: 2.54 mm, mounting: DIN rail mounting, locking: without, mounting: without, type of packaging: packed in cardboard, Item with gold-plated contacts, bus connectors for connecting with electronics housings, 7 parallel contacts/1 serial contact

TBUS8-25,0-PPPPPPSS-7035 - DIN rail bus connectors

2202895

<https://www.phoenixcontact.com/us/products/2202895>

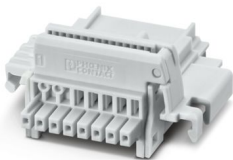

DIN rail connector, color: light grey, nominal current: 6 A, 4 A (parallel contacts) (Serial contacts), rated voltage (III/2): 32 V, number of positions: 8, product range: TBUS8-25..., pitch: 2.54 mm, mounting: DIN rail mounting, locking: without, mounting: without, type of packaging: packed in cardboard, Item with gold-plated contacts, bus connectors for connecting with electronics housings, 6 parallel contacts/2 serial contacts

ICS50-B100X98-V-V-7035 - Mounting base housing

1076998

<https://www.phoenixcontact.com/us/products/1076998>



TBUS8-25,0-PPPPSSSS-7035 - DIN rail bus connectors

1156781

<https://www.phoenixcontact.com/us/products/1156781>

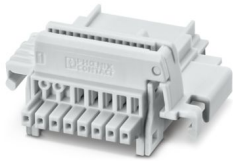

DIN rail connector, color: light grey, nominal current: 6 A, 4 A (parallel contacts) (Serial contacts), rated voltage (III/2): 32 V, number of positions: 8, product range: TBUS8-25..., pitch: 2.54 mm, mounting: DIN rail mounting, locking: without, mounting: without, type of packaging: packed in cardboard, Item with gold-plated contacts, bus connectors for connecting with electronics housings, 4 parallel contacts/4 serial contacts

TBUS8-25-BRIDGE-7035 - DIN rail bus connectors

1387008

<https://www.phoenixcontact.com/us/products/1387008>



DIN rail bus adapter for ICS, overall width: 25 mm, 8 parallel positions, color: light grey (similar to RAL 7035)

ICS50-B100X98-V-V-7035 - Mounting base housing



1076998

<https://www.phoenixcontact.com/us/products/1076998>

TBUS8-SPL-KIT-7035 - DIN rail bus connectors

1488805

<https://www.phoenixcontact.com/us/products/1488805>

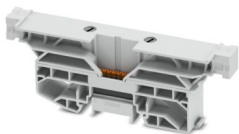

DIN rail connector, nominal cross section: 0.5 mm², nominal current: 6 A (parallel contacts), rated voltage (III/2): 32 V, contact surface: Gold, contact connection type: Socket, number of potentials: 8, number of positions: 8, number of connections: 8, product range: TBUS8..2,54, pitch: 2.54 mm, connection method: Push-in spring connection, mounting: DIN rail mounting, conductor/PCB connection direction: 0 °, locking: Snap-in locking, mounting: without, type of packaging: packed in cardboard

TBUS8-TAP-KIT-7035 - DIN rail bus connectors

1488806

<https://www.phoenixcontact.com/us/products/1488806>

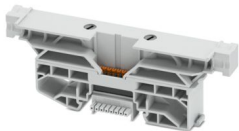

DIN rail connector, nominal cross section: 0.5 mm², nominal current: 6 A (parallel contacts), rated voltage (III/2): 32 V, contact surface: Gold, contact connection type: Socket, number of potentials: 8, number of positions: 8, number of connections: 8, product range: TBUS8..2,54, pitch: 2.54 mm, connection method: Push-in spring connection, mounting: DIN rail mounting, conductor/PCB connection direction: 0 °, locking: Snap-in locking, mounting: without, type of packaging: packed in cardboard

ICS50-B100X98-V-V-7035 - Mounting base housing



1076998

<https://www.phoenixcontact.com/us/products/1076998>

ICC25-TP2,5/4L5,0-7035 - PCB terminal block

1474487

<https://www.phoenixcontact.com/us/products/1474487>



PCB terminal block, nominal current: 18 A, rated voltage (III/2): 300 V, nominal cross section: 2.5 mm², number of potentials: 4, number of rows: 1, number of positions per row: 4, product range: ICC...-TP2,5/..L5,0, pitch: 5 mm, connection method: Push-in spring connection, mounting: Wave soldering, conductor/PCB connection direction: 0 °, color: light grey, Pin layout: Linear pinning, number of solder pins per potential: 1, type of packaging: packed in cardboard. Product with pin output on left side

ICC25-TP2,5/4R5,0-7035 - PCB terminal block

1474491

<https://www.phoenixcontact.com/us/products/1474491>



PCB terminal block, nominal current: 18 A, rated voltage (III/2): 300 V, nominal cross section: 2.5 mm², number of potentials: 4, number of rows: 1, number of positions per row: 4, product range: ICC...-TP2,5/..R5,0, pitch: 5 mm, connection method: Push-in spring connection, mounting: Wave soldering, conductor/PCB connection direction: 0 °, color: light grey, Pin layout: Linear pinning, number of solder pins per potential: 1, type of packaging: packed in cardboard. Product with pin output on right side

ICS50-B100X98-V-V-7035 - Mounting base housing



1076998

<https://www.phoenixcontact.com/us/products/1076998>

ICC25-TP1,5/5L3,5-7035 - PCB terminal block

1474497

<https://www.phoenixcontact.com/us/products/1474497>



PCB terminal block, nominal current: 8 A, rated voltage (III/2): 150 V, nominal cross section: 1.5 mm², number of potentials: 5, number of rows: 1, number of positions per row: 5, product range: ICC..-TP1,5/..L3,5, pitch: 3.5 mm, connection method: Push-in spring connection, mounting: Wave soldering, conductor/PCB connection direction: 0 °, color: light grey, Pin layout: Linear pinning, number of solder pins per potential: 1, type of packaging: packed in cardboard. Product with pin output on left side

ICC25-TP1,5/5R3,5-7035 - PCB terminal block

1474499

<https://www.phoenixcontact.com/us/products/1474499>



PCB terminal block, nominal current: 8 A, rated voltage (III/2): 150 V, nominal cross section: 1.5 mm², number of potentials: 5, number of rows: 1, number of positions per row: 5, product range: ICC..-TP1,5/..R3,5, pitch: 3.5 mm, connection method: Push-in spring connection, mounting: Wave soldering, conductor/PCB connection direction: 0 °, color: light grey, Pin layout: Linear pinning, Solder pin [P]: 2.8 mm, number of solder pins per potential: 1, type of packaging: packed in cardboard. Product with pin output on right side

ICS50-B100X98-V-V-7035 - Mounting base housing



1076998

<https://www.phoenixcontact.com/us/products/1076998>

ICC25-TS2,5/4L5,0-7035 - PCB terminal block

1380293

<https://www.phoenixcontact.com/us/products/1380293>



PCB terminal block, nominal current: 24 A, rated voltage (III/2): 300 V, nominal cross section: 2.5 mm², number of potentials: 4, number of rows: 1, number of positions per row: 4, product range: ICC...-TS2,5/..L5,0, pitch: 5 mm, connection method: Screw connection with tension sleeve, screw head form: H1L Slotted Phillips recess, mounting: Wave soldering, conductor/PCB connection direction: 0 °, color: light grey, Pin layout: Linear pinning, number of solder pins per potential: 1, type of packaging: packed in cardboard. Product with pin output on left side

ICC25-TS2,5/4R5,0-7035 - PCB terminal block

1380294

<https://www.phoenixcontact.com/us/products/1380294>



PCB terminal block, nominal current: 24 A, rated voltage (III/2): 300 V, nominal cross section: 2.5 mm², number of potentials: 4, number of rows: 1, number of positions per row: 4, product range: ICC...-TS2,5/..R5,0, pitch: 5 mm, connection method: Screw connection with tension sleeve, screw head form: H1L Slotted Phillips recess, mounting: Wave soldering, conductor/PCB connection direction: 0 °, color: light grey, Pin layout: Linear pinning, number of solder pins per potential: 1, type of packaging: packed in cardboard. Product with pin output on right side

ICS50-B100X98-V-V-7035 - Mounting base housing



1076998

<https://www.phoenixcontact.com/us/products/1076998>

ICC25-TS1,5/5L3,5-7035 - PCB terminal block

1380295

<https://www.phoenixcontact.com/us/products/1380295>

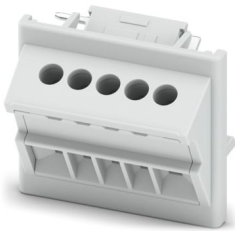

PCB terminal block, nominal current: 16 A, rated voltage (III/2): 150 V, nominal cross section: 1.5 mm², number of potentials: 5, number of rows: 1, number of positions per row: 5, product range: ICC..-TS1,5/..L3,5, pitch: 3.5 mm, connection method: Screw connection with tension sleeve, screw head form: L Slotted, mounting: Wave soldering, conductor/PCB connection direction: 0 °, color: light grey, Pin layout: Linear pinning, number of solder pins per potential: 1, type of packaging: packed in cardboard. Product with pin output on left side

ICC25-TS1,5/5R3,5-7035 - PCB terminal block

1380298

<https://www.phoenixcontact.com/us/products/1380298>

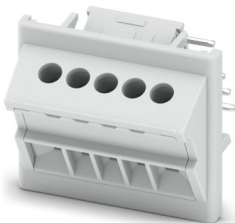

PCB terminal block, nominal current: 16 A, rated voltage (III/2): 150 V, nominal cross section: 1.5 mm², number of potentials: 5, number of rows: 1, number of positions per row: 5, product range: ICC..-TS1,5/..R3,5, pitch: 3.5 mm, connection method: Screw connection with tension sleeve, screw head form: L Slotted, mounting: Wave soldering, conductor/PCB connection direction: 0 °, color: light grey, Pin layout: Linear pinning, number of solder pins per potential: 1, type of packaging: packed in cardboard. Product with pin output on right side

ICS50-B100X98-V-V-7035 - Mounting base housing



1076998

<https://www.phoenixcontact.com/us/products/1076998>

PSPT 2,5/ 4-ST KMGY - PCB connectors

2202344

<https://www.phoenixcontact.com/us/products/2202344>



PCB connector, nominal cross section: 2.5 mm², color: light grey, nominal current: 16 A, rated voltage (III/2): 300 V, contact surface: Tin, contact connection type: Socket, number of potentials: 4, number of rows: 1, number of positions: 4, number of connections: 4, product range: PSPT 2,5/..-ST, pitch: 5 mm, connection method: Push-in spring connection, conductor/PCB connection direction: 0 °, locking clip: - Locking clip, locking: without, mounting: without, type of packaging: packed in cardboard, Color of the spring lever: orange

MSTBT 2,5 HC/ 4-STP GY7035 - PCB connectors

2200332

<https://www.phoenixcontact.com/us/products/2200332>



PCB connector, nominal cross section: 2.5 mm², color: light grey, nominal current: 16 A (see derating curve), rated voltage (III/2): 320 V, contact surface: Tin, contact connection type: Socket, number of rows: 1, number of positions: 4, product range: MSTBT 2,5 HC/..-STP, pitch: 5 mm, connection method: Screw connection with tension sleeve, conductor/PCB connection direction: 0 °, locking clip: - Locking clip, plug-in system: COMBICON MSTB 2,5 HC, locking: without, mounting: without

Phoenix Contact 2024 © - all rights reserved
<https://www.phoenixcontact.com>

Phoenix Contact USA
586 Fulling Mill Road
Middletown, PA 17057, United States
(+717) 944-1300
info@phoenixcon.com