

THICK-FILM CHIP RESISTOR

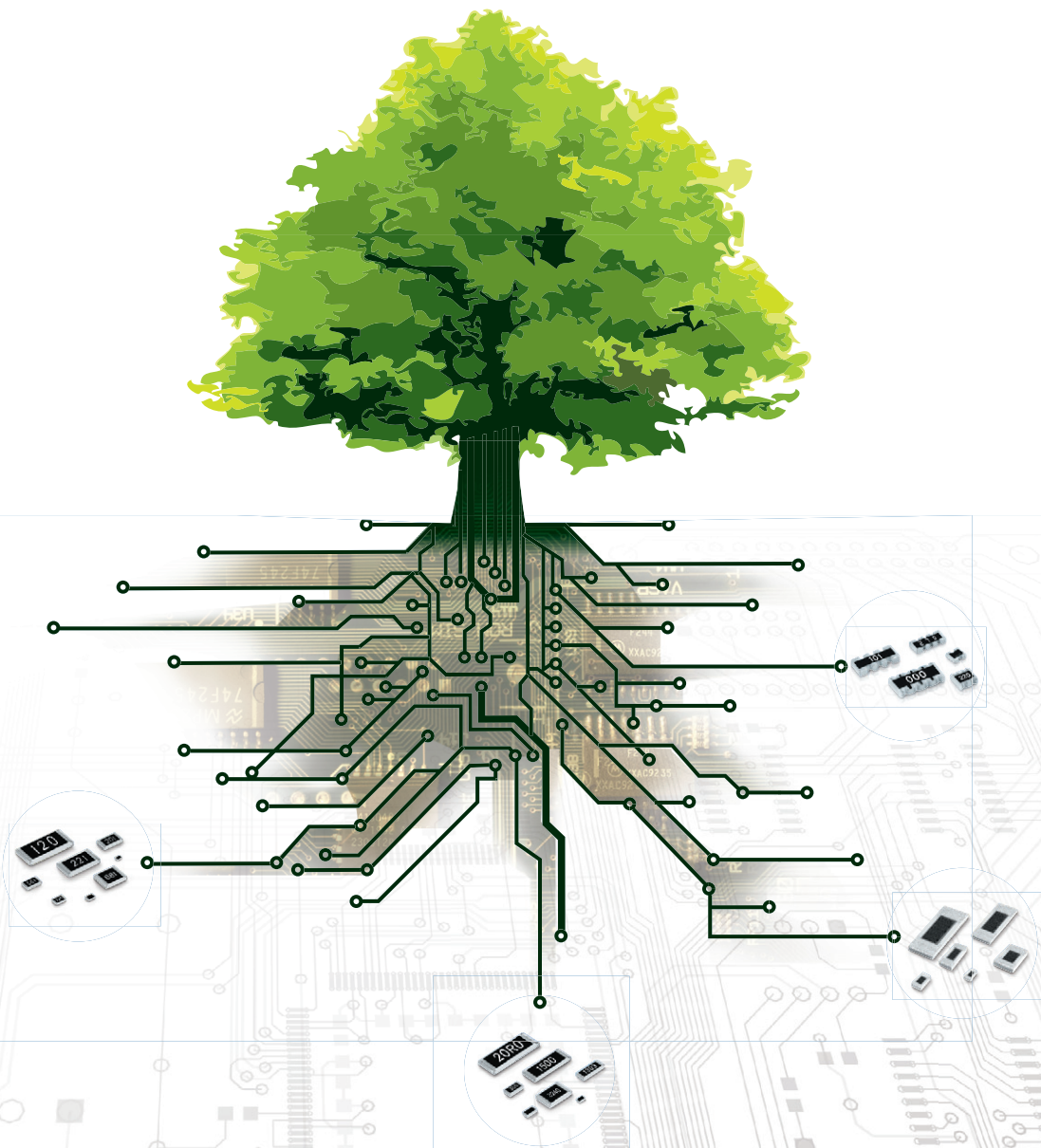



We, Samsung, declare that our component Chip Resistor is produced in accordance with EU RoHS directive.

1. RoHS Compliance and restriction of Br

The following restricted materials are not used in packaging materials as well as products in compliance with the law and restriction.

- Cd, Pb, Hg, Cr+6, As, Br and the compounds, PCB, asbestos
- Bromic materials : PBBs, PBBOs, PBDO, PBDE, PBB

2. No use of materials breaking Ozone layer

The following ODS materials are not used in our fabrication process.

- ODS material : Freon, Haron, 1-1-1 TCE, CCl4, HCFC

If you want more detailed Information, Please Visit Samsung Electro-mechanics Website
[<http://www.sem.samsung.com>, <http://www.semlcr.com>]

CONTENTS

Operation Notes	4	Operation Notes
Example of Land Pattern Design	5	Example of Land Pattern Design
Recommended Soldering Conditions	6	Recommended Soldering Conditions
General Structure	7	General Structure
General	8	General
Precision	10	Precision
Jumper	12	Jumper
Low ohms(RC Series)	14	Low ohms (RC Series)
Low ohms(RUT Series)	16	Low ohms (RUT Series)
Ultra Low Ohms(RU Series)	18	Ultra Low Ohms (RU Series)
Ultra Low Ohms(RUW Series)	20	Ultra Low Ohms (RUW Series)
Ultra Low Ohms(RUK Series)	22	Ultra Low Ohms (RUK Series)
Arrays(CONVEX Type)	24	Arrays (CONVEX Type)
Arrays(CONCAVE Type)	26	Arrays (CONCAVE Type)
Arrays(FLAT Type)	28	Arrays (FLAT Type)
Arrays for Memory Modules	30	Arrays for Memory Modules
Attenuator	32	Attenuator
Characteristics Performance	34	Characteristics Performance
Packaging	36	Packaging
Standard Resistance Value	38	Standard Resistance Value

Operation Notes

Applications

- Chip resistors are designed for general electronic devices such as home appliances, computer, mobile communications, digital circuit, etc. If you require our products with high reliability-performing at more than 125°C or below -55°C- for medical equipments, aircrafts, high speed machines, military usage, and items that can affect human life or if you need to use in specific conditions (corrosive gas atmosphere like H₂S etc.), please contact us beforehand.
- Normal operation temperature ranges (°C): -55°C~+155°C
- Others (rectangular, array_Flat type, trimmable) : -55°C~+125°C
- Although resistor body is coated, sharp excessive impact should be avoided to prevent damages and adverse effects on characteristics (resistor value, open circuited, T.C.R.).

Mounting

Please give more attention not to press the chip owing to the nozzle's improper height when it is mounted on PCB. (Excessive pressure may cause exterior damage, change in resistance, circuit open, etc.)

Safety precautions

- These products are designed and produced for applying to the ordinary electronic equipments. (AV equipment, OA equipment, Telecommunication equipment, etc)
- Consult with our sales department before applying in the devices that require extremely high reliability such as medical equipments, transport equipments, aircrafts/spacecrafts, nuclear power controllers, fuel controllers, car equipments including car accessories and other safety devices.
- Following special environments, and such environmental conditions may affect the performance of the product. Please verify the performance and reliability thoroughly prior to use.
 - a) Using in various type of Liquid including water, oil, organic solvent and other chemicals.
 - b) Using in the places where the products are exposed to direct sunlight, sea wind, corrosive gases (including Cl, H₂S, NH₃, SO₂, NO₂), static electricity, electromagnetic waves and dusty air.
 - c) Using close to heat generating components or other flammable items.
 - d) Using in the places that is sealed or coated with resins or other coating materials after soldering.
 - e) Using in places subject to dew condensation.
- These products are not radiation resistant.
- The company is not responsible for any problems resulting from using of the products under the conditions not recommended herein.
- The company should notify any safety issues of the products to the customer. And the safety of the products should be monitored by the customer periodically.

Storage

To maintain proper quality of chip components, the following precautions are required for storage environment, method and period.

- Storage Environment
 - Make sure that the ambient temperature is within 5°C~40°C and the ambient humidity is within 20~70%RH.
 - Chip components may be deformed, if the temperature of packaged components exceeds 40°C.
 - Do not store where the soldering properties can be deteriorated by harmful gas such as sulphurous gas, chlorine gas, etc.
 - Bulk packed chip components should be used as soon as the seal is opened, thus preventing the solderability from deteriorating.
 - The remaining unused chips should be put in the original bag and sealed again or store in a desiccator containing a desiccating agent.
- Storage Time Period
 - Stored chip components should be used within 6 months after receiving the components. If 6 months or more have elapsed, please check the solderability before actually using.

Cleaning

After Soldering Cleaning, soldering flux & Ionic cleaning liquid should be avoided on product. If any possibility on product, please take a test before usage.

Caution for Chip Resistor Separation from PCB.

Chip resistor installation on PCB is a similar phenomenon on a chocolate chip on top of a cake. PCB has enough flexibility on outer force but Chip resistor can be defected without any bending. (By chip resistor use of Ceramic, solder, metal) Therefore, when separating a Chip resistor from a PCB, beware of any crack on the chip.

Others

- Manual work
 - Whenever separating chip resistor from PCB, do not re-use the chip resistor for circuit safety.
 - Electrical specification of chip resistors can be changed by soldering iron after separation.
 - Re-use of separated chip resistor should be prohibited.
- Do not use more than rated voltage. (Please check the contents of each product)

Example of Land Pattern Design

- When designing P.C.B, the shape and size of the solder lands must allow for the proper amount of solder under the resistor. The amount of solder at the end terminations has a direct effect on the probability that the chip will crack. The greater amount of solder, the amount of stress on the chip, and the more likely that it will break. Use the following illustrations as guidelines for proper 'solder lands design'.

For Chip Type

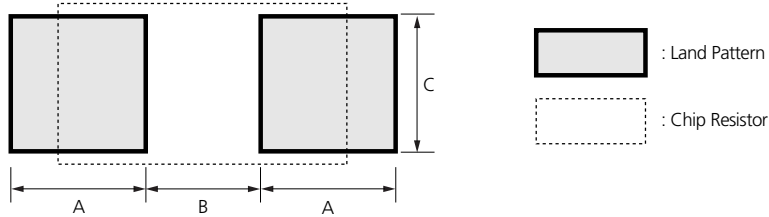

• Reflow soldering (UNIT: mm)					• Reflow soldering (RU, RUW, RUK) (UNIT: mm)					• Flow soldering (UNIT: mm)				
Type	A	B	2A+B	C	Type	A	B	2A+B	C	Type	A	B	2A+B	C
0402	0.17	0.20	0.54	0.18	1005	0.8	0.5	2.1	0.5	1005	0.7	0.5	1.9	0.5
0603	0.37	0.28	1.02	0.29	1608	0.8	0.5	2.1	0.8	1608	0.9	0.8	2.6	0.8
1005	0.6	0.5	1.7	0.5	2012	0.9	0.8	2.6	1.2	2012	1.0	1.4	3.4	1.3
1608	0.8	0.8	2.4	0.8	3216	1.7	1.2	4.6	1.4	3216	1.4	1.8	4.6	1.6
2012	0.9	1.4	3.2	1.2	3225	1.7	1.2	4.6	2.6	3225	1.4	1.8	4.6	2.6
3216	1.3	1.8	4.4	1.5	5025	2.15	1.8	6.1	2.6	5025	1.5	3.3	6.3	2.5
3225	1.3	1.8	4.4	2.4	6432	2.3	3.0	7.6	3.3	6432	1.5	4.6	7.6	3.2
5025	1.4	3.3	6.1	2.4										
6432	1.4	4.6	7.4	3.0										

For Array Type

- Convex type

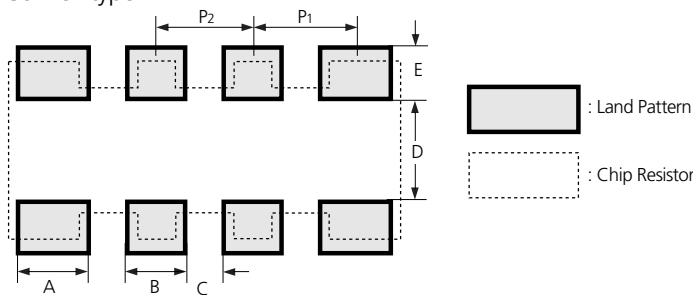

- Concave type

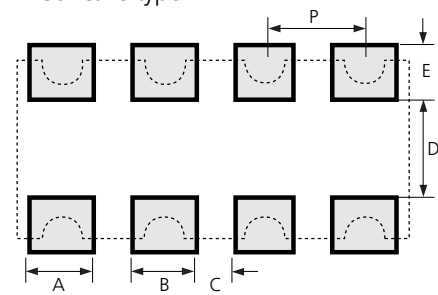

Type	A	B	C	D	E	P ₁	P ₂
062P	0.20	0.20	0.30	0.30	0.30	0.6	-
064P	0.20	0.20	0.20	0.30	0.30	0.5	0.5
10AT	0.4	0.4	0.25	0.5	0.5	0.65	-
102P	0.4	0.4	0.25	0.5	0.5	0.65	-
104P	0.7	0.3	0.2	0.5	0.5	0.55	0.5
164P	0.7	0.5	0.3	0.9	0.8	0.9	0.8

Type	A	B	C	D	E	P
102P	0.3	0.3	0.2	0.5	0.4	0.5
104P	0.3	0.3	0.2	0.5	0.4	0.5

- This is the recommended land pattern for designing PCB. This pattern does not guarantee any characteristic of other product.

The specifications and designs contained herein may be subject to change without notice. Please contact our sales representatives or product engineers before order.

Operation Notes

Example of land Pattern Design

Recommended Soldering Conditions

General Structure

General

Precision

Jumper

Low ohms (RC Series)

Low ohms (RUT Series)

Ultra Low Ohms (RU Series)

Ultra Low Ohms (RUW Series)

Ultra Low Ohms (RUK Series)

Arrays (CONVEX Type)

Arrays (CONCAVE Type)

Arrays (FLAT Type)

Arrays for Memory Modules

Attenuator

Characteristics Performance

Packaging

Standard Resistance Value

Recommended Soldering Conditions

Abstract

- There are 3 soldering methods.
 - Flow(wave) soldering.
 - Reflow soldering. (Reflow soldering is broadly divided into the total heating method and local heating method.)
 - Iron soldering.

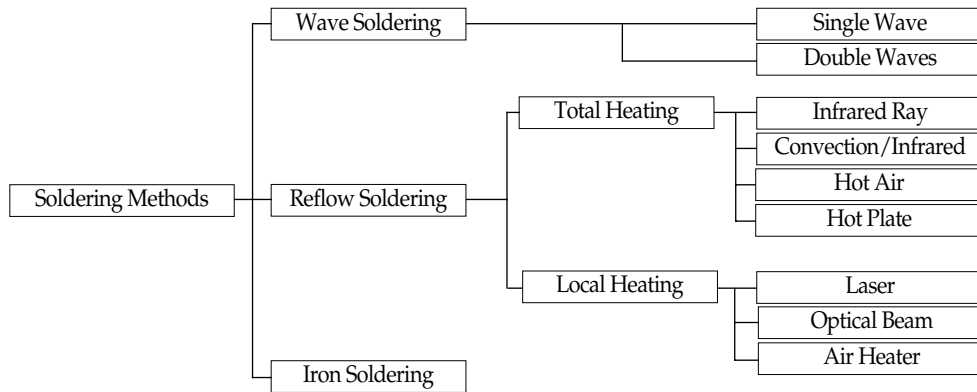

Since Chip resistors come into direct contact with melted solder during soldering, it is exposed to potential mechanical stress caused by the sudden temperature change. The chip resistors may also be subject to silver migration, and to contamination by the flux. Because of these factors, soldering technique is critical.

Flow(wave) Soldering

- Features

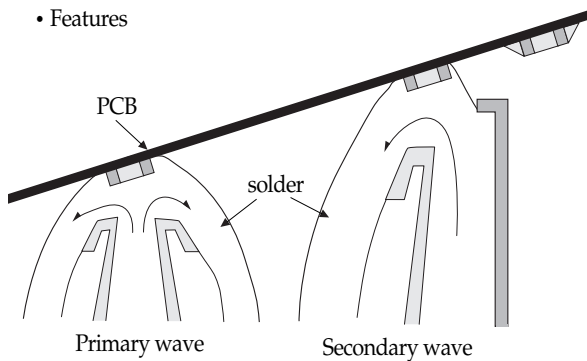

There are two types of soldering methods in flow(wave) soldering. One is single wave soldering, the other is a double waves soldering. However, double waves soldering is mainly used. This method is designed so that the continuous and multiple dipping processes by waves of solder having completely different primary and secondary characteristics and waveforms. With the primary wave, a comparatively strong jet flow is used to remove the flux gas and to solder. With the secondary wave, it is used to remove excessive solder. With the primary wave, the solder flows into a very small gap between components and air bubbles remaining on the soldered joint are removed. With the secondary wave, the peel back is used to prevent bridging.

- Preheating

If a chip component is heated suddenly during soldering, it may be cracked by the thermal shock caused by the temperature difference between the surface and the inside of the chip. To prevent this, a full preheating is necessary. In case of wave soldering, the temperature difference between solder and surface of the component is kept within 150°C. Also when cooling is done by dipping into solvent, care should be taken to keep the temperature difference within 150°C.

- Standard Soldering Condition

Soldering must be carried out without exceeding the approved soldering temperature and time shown within the shaded area of the right graph. An excessively long soldering time or high soldering temperature results in leaching of the outer terminations. When a PCB is warped, mechanical stress applied to the chip will be increased and might be a cause of chip crack, especially if there is big amount of solder on the chip. So, care should be taken not to use excessive amount of solder on the PCB. For the flow(wave) soldering, the solder amount can be controlled by land size.

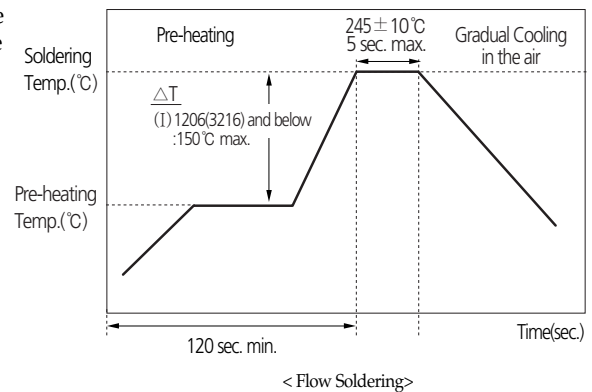

Reflow Soldering

• Pre-heating and cooling

In the reflow soldering method, a full pre-heating at the proper temperature is necessary to dry and activate solder paste. Tomb-stoning can be reduced by preheating at 150~180°C for more than 1 minute. Also when cooling is done by dipping into solvent, care should be taken to keep the temperature difference within 150°C.

• Standard Reflow Soldering Condition

Soldering must be carried out without exceeding the approved soldering temperature and time shown within the shaded area of the right graph. This prevents the terminations from leaching and characteristics from deteriorating. When soldering is repeated, the allowed time is the accumulated time.

• Standard solder amount

When a PCB is warped, mechanical stress applied to the chip should be reduced, and for doing so, care should be taken not to use excessive amount of solder on the PCB. In case of the reflow method, the thickness of the coated solder paste is controlled to prevent excessive solder. The thickness of solder paste should be 100~300 μ m.

• Tombstoning and Prevention

When reflow soldering, or especially vapor phase soldering (VPS), small chip components of less than RC3216 type may break away from solder and stand on end. This is commonly known as tombstoning or the Manhattan phenomenon.

- Preventing tombstoning

Keep land size as small as possible.

Keep the pre-heating conditions properly

(Pre-heating temperature : 150 ~ 180°, Pre-heating time : more than 1 min.)

Keep the solder paste quantity not too much and uniform for every lands.

Keep the position of chips properly.

At around the soldering temperature, keep minimize the difference of the temperature between the electrodes of a chip.

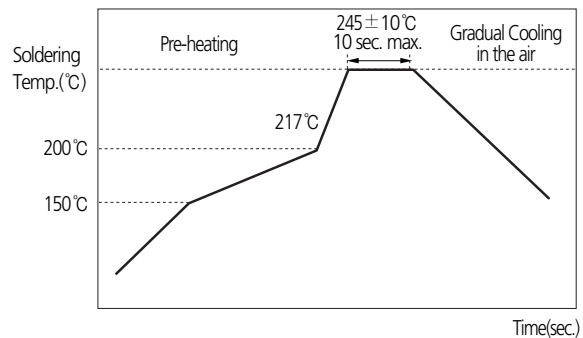

< Reflow Soldering >

Operation Notes

Example of land Pattern Design

Recommended Soldering Conditions

General Structure

General

Precision

Jumper

Low ohms (RC Series)

Low ohms (RUT Series)

Ultra Low Ohms (RU Series)

Ultra Low Ohms (RUW Series)

Ultra Low Ohms (RUK Series)

Arrays (CONVEX Type)

Arrays (CONCAVE Type)

Arrays (FLAT Type)

Arrays for Memory Modules

Attenuator

Characteristics Performance

Packaging

Standard Resistance Value

Iron Soldering

When using a soldering iron or any other soldering operation, the permissible temperature and time should not be exceeded that in the reflow soldering. In other to prevent the external terminations from leaching and characteristics from deteriorating, the tip of the soldering iron should not touch the chip component (ceramic element, resin case, etc.). Soldering with a soldering iron and correcting with a soldering iron can be performed right the following conditions.

Item	Condition
Temperature at tip	350°C Max.
Soldering iron output	20-Watt Max.
End of soldering iron	∅3mm Max.
Note	Do not directly touch the chip by the tip of the iron.

General Structure of the Chip Resistor

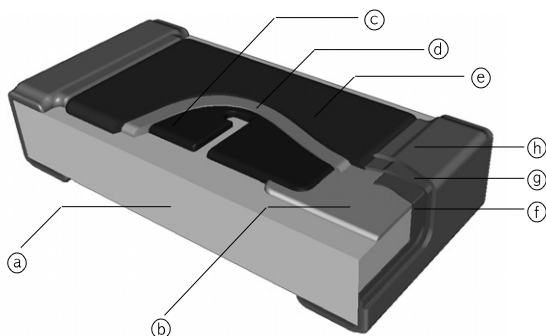

No.	Name	Main Substance
(a)	Ceramic Substrate	Al ₂ O ₃
(b)	Inner Electrode	Ag / Cu
(c)	Resistor	Ag-Pd / Cu-Ni
(d)	Glass Coat	Bi ₂ O ₃ , SiO ₂
(e)	Protective Coat	Polymer / Glass
(f)	Terminal Coat	Ni-Cr Alloy / Ag
(g)	Ni Plate	Ni
(h)	Sn Plate	Sn

The specifications and designs contained herein may be subject to change without notice. Please contact our sales representatives or product engineers before order.

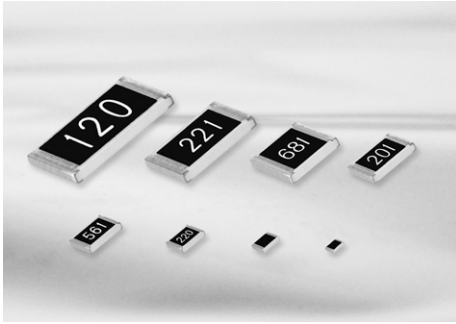

Feature

- Very small, thin, and light weight.
- Both flow and reflow soldering are applicable.
- Owing to the reduced lead inductance, the high frequency characteristic is excellent.
- Suitable size and packaging for surface mount assembly.

The product of lead-free terminal is RoHS compliant.

PbO(lead oxide) is included in the glass of our product which is prescribed on RoHS appendix as an exception.

Application

- General purpose
- Home Appliances
(DVD, Digital TV, Digital Camera, Audio, Tunner)
- For Computers & Communications
(Notebook, Memory Module, Mobile, Network Equipment, etc)

Structure and Dimensions

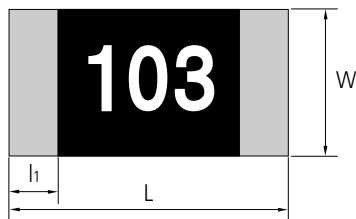

<Top View>

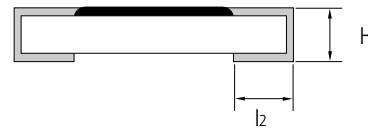

<Side View>

(UNIT: mm)

Type	Inch	Power(W)	L	W	H	l ₁	l ₂	Average Weight
RC0402	01005	1/32	0.40±0.02	0.20±0.02	0.13±0.02	0.10±0.03	0.10±0.03	0.04mg
RC0603	0201	1/20	0.60±0.03	0.30±0.03	0.23±0.03	0.10±0.05	0.15±0.05	0.15mg
RC1005	0402	1/16	1.00±0.05	0.50±0.05	0.35±0.05	0.20±0.10	0.25±0.10	0.6mg
RC1608	0603	1/10	1.60±0.10	0.80±0.10	0.45±0.10	0.30±0.20	0.35±0.10	2.1mg
RC2012	0805	1/8	2.00±0.20	1.25±0.15	0.50±0.10	0.40±0.20	0.35±0.20	4.9mg
RC3216	1206	1/4	3.20±0.20	1.60±0.15	0.55±0.10	0.45±0.20	0.40±0.20	9.5mg
RC3225	1210	1/3	3.20±0.20	2.55±0.20	0.55±0.10	0.45±0.20	0.40±0.20	16mg
RC5025	2010	2/3	5.00±0.20	2.50±0.20	0.55±0.10	0.60±0.20	0.60±0.20	26mg
RC6432	2512	1	6.30±0.20	3.20±0.20	0.55±0.10	0.60±0.20	0.60±0.20	41mg

Parts Numbering System

- The part number system shall be in the following format

RC	2012	J	100	CS
Code Designation	Dimension & Size Code	Tolerance	Resistance Value	Packaging Code
RC: Chip Resistor	0402: 0.4 × 0.2(mm) - 01005(inch) 0603: 0.6 × 0.3(mm) - 0201(inch) 1005: 1.0 × 0.5(mm) - 0402(inch) 1608: 1.6 × 0.8(mm) - 0603(inch) 2012: 2.0 × 1.2(mm) - 0805(inch) 3216: 3.2 × 1.6(mm) - 1206(inch) 3225: 3.2 × 2.5(mm) - 1210(inch) 5025: 5.0 × 2.5(mm) - 2010(inch) 6432: 6.4 × 3.2(mm) - 2512(inch)	F : ±1% G : ±2% J : ±5% K : ±10%	3 or 4 digits coding system (IEC coding system) 3digits (E-24 series) 4digits (E-96 series)	GS: Bulk Packaging CS: Tape Packaging 7" ES: Tape Packaging 10" AS: Tape Packaging 13"

Specification

Type	Power Rating (W)	Working Voltage (MAX)	Overload Voltage (MAX)	TCR (ppm/°C)	Resistance Range (Ω)	Rated Ambient Temperature	Rated Working Temperature
RC 0402	1/32	15(V)	30(V)	1~99 Ω: ±300 100~1 MΩ: ±250	1 Ω~1 MΩ	70°C	-55°C~+125°C
RC 0603	1/20	25(V)	50(V)	1~9.9 Ω: +300,-200 10 Ω~1 MΩ: ±100 (0603: ±250) 1.1 MΩ~10 MΩ: ±300	1 Ω~10 MΩ		-55°C~+155°C
RC 1005	1/16	50(V)	100(V)				
RC 1608	1/10						
RC 2012	1/8	150(V)	300(V)				
RC 3216	1/4	200(V)	400(V)				
RC 3225	1/3						
RC 5025	2/3						
RC 6432	1						

- Rated voltage (V) = $\sqrt{\text{Rated power(W)} \times \text{Normal resistance value (R)}}$
Rated voltage should be lower than (MAX) working voltage.

Power Derating Curve

The rated power is the maximum continuous loading power at 70°C ambient temperature.
For ambient temperature above 70°C, the loading power follows the below power derating curve.
(The load current shall be derated according to derating curve in case of the 'Jumper')

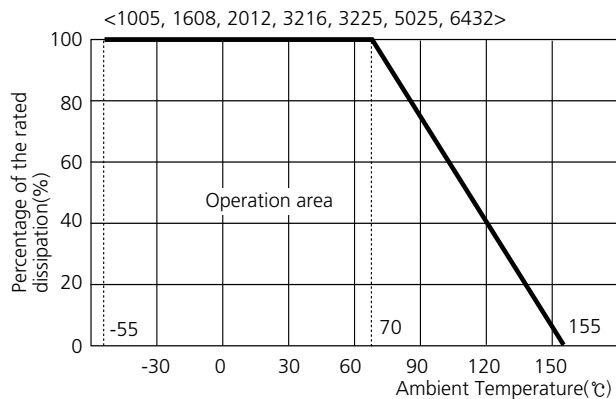
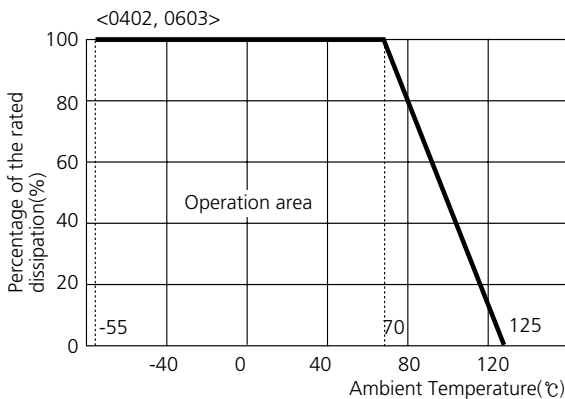

Marking

• 3 digits indication (E-24 series)	• 4 digits indication (E-96 series)
<ul style="list-style-type: none"> Left 2 digits represent significant figures. Last 1 digit represents exponential number of 10. Example: 103 Left 2 digits: 10 Last 1 digit: 3 $103 = 10 \times 10^3 \Omega = 10000 \Omega = 10k\Omega$ 	<ul style="list-style-type: none"> Left 3 digits represent significant figures. Last 1 digit represents exponential number of 10. Example: 1002 Left 3 digits: 100 Last 1 digit: 2 $1002 = 100 \times 10^2 \Omega = 10000 \Omega = 10k\Omega$
• 0603, 1005 type: No marking.	• 0603, 1005, 1608 type: No marking.

IEC Code System (E-96, E-24)

E-96	E-24	E-96	E-24	E-96	E-24	E-96	E-24
100		178		316		562	56
102	10	182	18	324	33	576	
105		187		332		590	
107		191		340		604	
110	11	196		348		619	
113		200	20	357	36	634	62
115		205		365		649	
118		210		374		665	
121	12	215		383	39	681	68
124		221	22	392		698	
127		226		402		715	
130		232		412		732	
133		237		422		750	75
137		243	24	432	43	768	
140		249		442		787	
143		255		453		806	
147		261		464		825	82
150	15	267		475	47	845	
154		274	27	487		866	
158		280		499		887	
162	16	287		511	51	909	
165		294		523		931	91
169		301	30	536		953	
174		309		549		976	

The specifications and designs contained herein may be subject to change without notice.
Please contact our sales representatives or product engineers before order.

Operation Notes

Example of land Pattern Design

Recommended Soldering Conditions

General Structure

General

Precision

Jumper

Low ohms (RC Series)

Low ohms (RUT Series)

Ultra Low Ohms (RU Series)

Ultra Low Ohms (RUW Series)

Ultra Low Ohms (RUK Series)

Arrays (CONVEX Type)

Arrays (CONCAVE Type)

Arrays (FLAT Type)

Arrays for Memory Modules

Attenuator

Characteristics Performance

Packaging

Standard Resistance Value

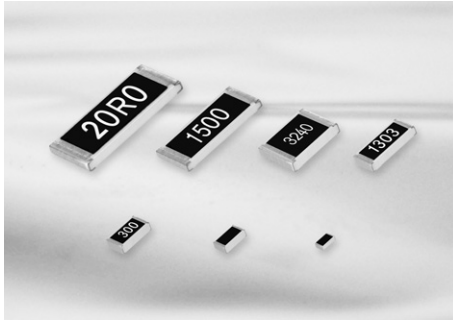

Feature

- Low tolerance ($\pm 0.5\%$)
- Both flow and reflow soldering are applicable.
- Suitable size and packaging for surface mount assembly.
- Owing to the reduced lead inductance, the high frequency characteristic is excellent.

The product of lead-free terminal is RoHS compliant. PbO(lead oxide) is included in the glass of our product which is prescribed on RoHS appendix as an exception.

Application

- Circuit for high precision resistance and reliability.
- For signal control part
- For tuning circuit.

Structure and Dimensions

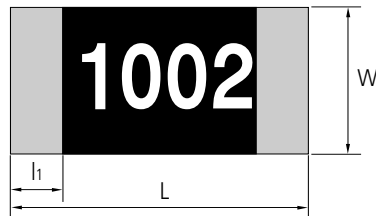

<Top View>



<Side View>

(UNIT: mm)

Type	Inch	Power(W)	L	W	H	l ₁	l ₂	Average Weight
RC1005	0402	1/16	1.00 \pm 0.05	0.50 \pm 0.05	0.35 \pm 0.05	0.20 \pm 0.10	0.25 \pm 0.10	0.6mg
RC1608	0603	1/10	1.60 \pm 0.10	0.80 \pm 0.10	0.45 \pm 0.10	0.30 \pm 0.20	0.35 \pm 0.10	2.1mg
RC2012	0805	1/8	2.00 \pm 0.20	1.25 \pm 0.15	0.50 \pm 0.10	0.40 \pm 0.20	0.35 \pm 0.20	4.9mg
RC3216	1206	1/4	3.20 \pm 0.20	1.60 \pm 0.15	0.55 \pm 0.10	0.45 \pm 0.20	0.40 \pm 0.20	9.5mg
RC3225	1210	1/3	3.20 \pm 0.20	2.55 \pm 0.20	0.55 \pm 0.10	0.45 \pm 0.20	0.40 \pm 0.20	16mg
RC5025	2010	2/3	5.00 \pm 0.20	2.50 \pm 0.20	0.55 \pm 0.10	0.60 \pm 0.20	0.60 \pm 0.20	26mg
RC6432	2512	1	6.30 \pm 0.20	3.20 \pm 0.20	0.55 \pm 0.10	0.60 \pm 0.20	0.60 \pm 0.20	41mg

Parts Numbering System

- The part number system shall be in the following format

RC	1005	D	1002	CS
Code Designation	Dimension & Size Code	Tolerance	Resistance Value	Packaging Code
RC: Chip Resistor	1005: 1.0 × 0.5(mm) - 0402(inch) 1608: 1.6 × 0.8(mm) - 0603(inch) 2012: 2.0 × 1.2(mm) - 0805(inch) 3216: 3.2 × 1.6(mm) - 1206(inch) 3225: 3.2 × 2.5(mm) - 1210(inch) 5025: 5.0 × 2.5(mm) - 2010(inch) 6432: 6.4 × 3.2(mm) - 2512(inch)	D: $\pm 0.5\%$	3 or 4 digits coding system (IEC coding system) 3digits (E-24 series) 4digits (E-96, E-192 series)	GS: Bulk Packaging CS: Tape Packaging 7" ES: Tape Packaging 10" AS: Tape Packaging 13"

Specification

Type	Power Rating (W)	Working Voltage (MAX)	Overload Voltage (MAX)	TCR (ppm/°C)	Resistance Range (Ω)	Rated Ambient Temperature	Rated Working Temperature
RC 1005	1/16	50(V)	100(V)	1~9.9Ω : ±300 10Ω~1MΩ : ±100 1.1MΩ~10MΩ : ±300	1Ω~10MΩ	70°C	-55°C~+155°C
RC 1608	1/10						
RC 2012	1/8	200(V)	400(V)				
RC 3216	1/4						
RC 3225	1/3						
RC 5025	2/3						
RC 6432	1						

- Rated voltage (V) = $\sqrt{\text{Rated power(W)} \times \text{Normal resistance value (R)}}$
Rated voltage should be lower than (MAX) working voltage.

Power Derating Curve

The rated power is the maximum continuous loading power at 70°C ambient temperature.
For ambient temperature above 70°C, the loading power follows the below power derating curve.

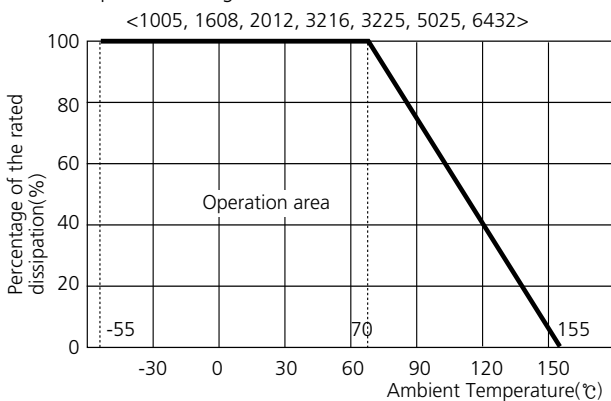

Marking

• 3 digits indication (E-24 series)

- Left 2 digits represent significant figures.
- Last 1 digit represents exponential number of 10.
- Example: **103**
Left 2 digits: 10
Last 1 digit: 3
 $103 = 10 \times 10^3 \Omega = 10000 \Omega = 10k\Omega$



- 1005 type: No marking.

• 4 digits indication (E-96, E-192 series)

- Left 3 digits represent significant figures.
- Last 1 digit represents exponential number of 10.
- Example: **1002**
Left 3 digits: 100
Last 1 digit: 2
 $1002 = 100 \times 10^2 \Omega = 10000 \Omega = 10k\Omega$



- 1005, 1608 type: No marking.

Significant Figure of Resistance Value

E192	E96	E24	E192	E96	E24	E192	E96	E24	E192	E96	E24	E192	E96	E24	E192	E96	E24	E192	E96	E24			
100	100	10	133	133		178	178		237	237		316	316		422	422		562	562	56	750	750	75
101			135			180		18	240		24	320			427			569			759		
102	102		137	137		182	182		243	243		324	324		432	432	43	576	576		768	768	
104			138			184			246			328			437			583			777		
105	105		140	140		187	187		249	249		332	332	33	442	442		590	590		787	787	
106			142			189			252			336			448			597			796		
107	107		143	143		191	191		255	255		340	340		453	453		604	604		806	806	
109			145			193			258			344			459			612			816		
110	110	11	147	147		196	196		261	261		348	348		464	464		619	619	62	825	825	82
111			149			198			264			352			470			626			835		
113	113		150	150	15	200	200	20	267	267		357	357		475	475		634	634		845	845	
114			152			203			271		27	361		36	481			642			856		
115	115		154	154		205	205		274	274		365	365		487	487		649	649		866	866	
117			156			208			277			370			493			657			876		
118	118		158	158		210	210		280	280		374	374		499	499		665	665		887	887	
120		12	160		16	213			284			379			505			673			898		
121	121		162	162		215	215		287	287		383	383		511	511	51	681	681	68	909	909	91
123			164			218			291			388			517			690			920		
124	124		165	165		221	221	22	294	294		392	392	39	523	523		698	698		931	931	
126			167			223			298			397			530			706			942		
127	127		169	169		226	226		301	301	30	402	402		536	536		715	715		953	953	
129			172			229			305			407			542			723			965		
130	130	13	174	174		232	232		309	309		412	412		549	549		732	732		976	976	
132			176			234			312			417			556			741			988		

The specifications and designs contained herein may be subject to change without notice.
Please contact our sales representatives or product engineers before order.

Operation Notes

Example of land Pattern Design

Recommended Soldering Conditions

General Structure

General

Precision

Jumper

Low ohms (RC Series)

Low ohms (RUT Series)

Ultra Low Ohms (RU Series)

Ultra Low Ohms (RUW Series)

Ultra Low Ohms (RUK Series)

Arrays (CONVEX Type)

Arrays (CONCAVE Type)

Arrays (FLAT Type)

Arrays for Memory Modules

Attenuator

Characteristics Performance

Packaging

Standard Resistance Value

Jumper

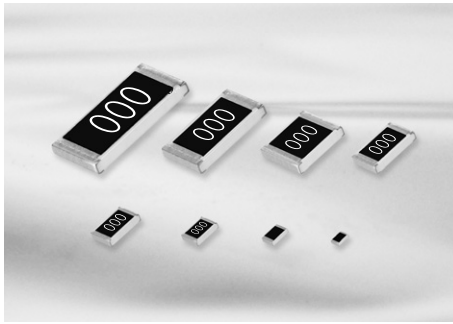

Feature

- Very small, thin, and light weight.
- Both flow and reflow soldering are applicable.
- Owing to the reduced lead inductance, the high frequency characteristic is excellent.
- Suitable size and packaging for surface mount assembly.

The product of lead-free terminal is RoHS compliant.

PbO(lead oxide) is included in the glass of our product which is prescribed on RoHS appendix as an exception.

Application

- General purpose
- Home Appliances
(DVD, Digital TV, Digital Camera, Audio, Tunner)
- For Computers & Communications
(Notebook, Memory Module, Mobile, Network Equipment, etc)

Structure and Dimensions

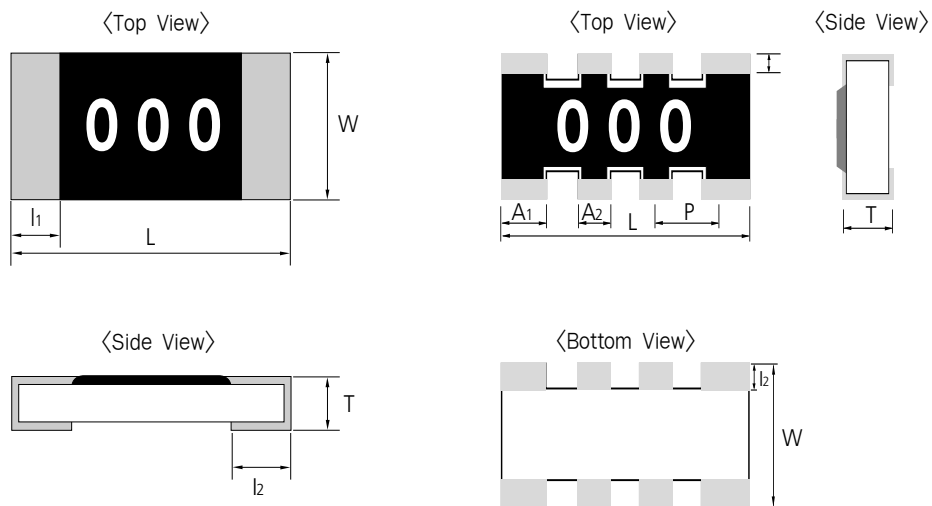

(UNIT: mm)

Type	Inch	Power(W)	L	W	T	A ₁	A ₂	l ₁	l ₂	P	Average Weight
RC0402	01005	1/32	0.40±0.02	0.20±0.02	0.13±0.02	-	-	0.10±0.03	0.10±0.03	-	0.04mg
RC0603	0201	1/20	0.60±0.03	0.30±0.03	0.23±0.03	-	-	0.10±0.05	0.15±0.05	-	0.15mg
RC1005	0402	1/16	1.00±0.05	0.50±0.05	0.35±0.05	-	-	0.20±0.10	0.25±0.10	-	0.6mg
RC1608	0603	1/10	1.60±0.10	0.80±0.10	0.45±0.10	-	-	0.30±0.20	0.35±0.10	-	2.1mg
RC2012	0805	1/8	2.00±0.20	1.25±0.15	0.50±0.10	-	-	0.40±0.20	0.35±0.20	-	4.9mg
RC3216	1206	1/4	3.20±0.20	1.60±0.15	0.55±0.10	-	-	0.45±0.20	0.40±0.20	-	9.5mg
RC3225	1210	1/3	3.20±0.20	2.55±0.20	0.55±0.10	-	-	0.45±0.20	0.40±0.20	-	16mg
RC5025	2010	2/3	5.00±0.20	2.50±0.20	0.55±0.10	-	-	0.60±0.20	0.60±0.20	-	26mg
RC6432	2512	1	6.30±0.20	3.20±0.20	0.55±0.10	-	-	0.60±0.20	0.60±0.20	-	41mg
RP102P	0404	1/16	1.00±0.10	1.00±0.10	0.35±0.10	0.33±0.10	0.33±0.10	0.20±0.10	0.25±0.10	0.65±0.10	1.1mg
RP104P	0804	1/16	2.00±0.10	1.00±0.10	0.35±0.10	0.40±0.15	0.30±0.15	0.15±0.10	0.25±0.10	0.50±0.15	2.2mg
RP164P	1206	1/16	3.20±0.10	1.60±0.10	0.50±0.10	0.60±0.15	0.40±0.15	0.30±0.15	0.30±0.15	0.80±0.15	8.9mg

Parts Numbering System

- The part number system shall be in the following format

RC	2012	J	000	CS
Code Designation	Dimension & Size Code	Tolerance	Resistance Value	Packaging Code
RC: Chip Resistor RP: Array	0402: 0.4 × 0.2(mm) - 01005(inch) 0603: 0.6 × 0.3(mm) - 0201(inch) 1005: 1.0 × 0.5(mm) - 0402(inch) 1608: 1.6 × 0.8(mm) - 0603(inch) 2012: 2.0 × 1.2(mm) - 0805(inch) 3216: 3.2 × 1.6(mm) - 1206(inch) 3225: 3.2 × 2.5(mm) - 1210(inch) 5025: 5.0 × 2.5(mm) - 2010(inch) 6432: 6.4 × 3.2(mm) - 2512(inch) 102P: 1.0 × 1.0(mm) - 0404(inch) 104P: 2.0 × 1.0(mm) - 0804(inch) 164P: 3.2 × 1.6(mm) - 1206(inch)	J: Max 50 mΩ	Jumer: 000	GS: Bulk Packaging CS: Tape Packaging 7" ES: Tape Packaging 10" AS: Tape Packaging 13"

Operation Notes

Example of land Pattern Design

Recommended Soldering Conditions

General Structure

General

Precision

Jumper

Low ohms (RC Series)

Low ohms (RUT Series)

Ultra Low Ohms (RU Series)

Ultra Low Ohms (RUW Series)

Ultra Low Ohms (RUK Series)

Arrays (CONVEX Type)

Arrays (CONCAVE Type)

Arrays (FLAT Type)

Arrays for Memory Modules

Attenuator

Characteristics Performance

Packaging

Standard Resistance Value

Jumper Resistors

Type	Resistance	Current Rating	Rated Ambient Temperature	Rated Working Temperature	Marking
RC0402	50mΩ max	0.5 (A)	70℃	-55℃ ~ +125℃	X
RC0603					
RC1005		1.0 (A)			
RC1608					
RC2012		2.0 (A)			
RC3216					
RC3225					
RC5025					
RC6432					
RP102P				1 ~ 1M	1.0 (A)
RP104P	O				
RP164P	X				
	O				

Power Derating Curve

The rated power is the maximum continuous loading power at 70℃ ambient temperature.
For ambient temperature above 70℃, the loading power follows the below power derating curve.
(The load current shall be derated according to derating curve in case of the 'Jumper')

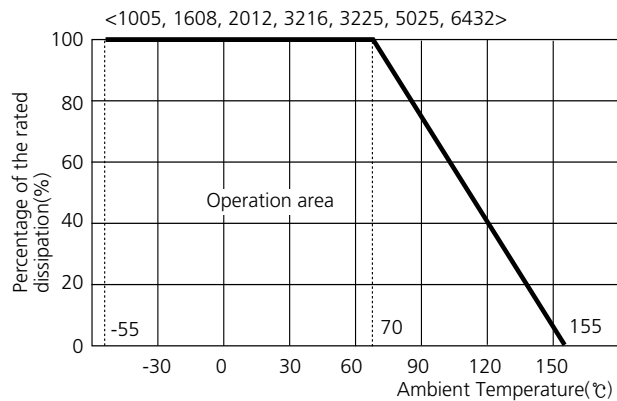
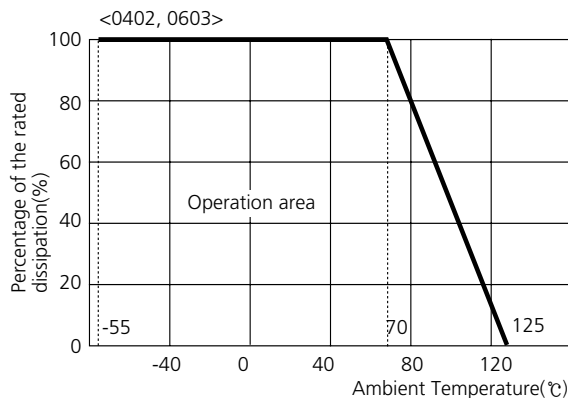

Low Ohms(RC Series)

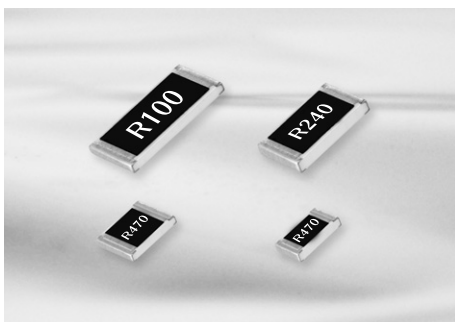

Feature

- Under 1 ohms, precision resistance.
- Both flow and reflow soldering are applicable.
- The product of lead-free terminal is RoHS compliant.
100% Lead-free Products (PbO is not used)

Application

- Current detect.
- Safe circuit through protecting over-current flow.
- Power supplying part, DC power charger, adapter.
- Mobile Phone, HDD, DSC, LCD.

Structure and Dimensions

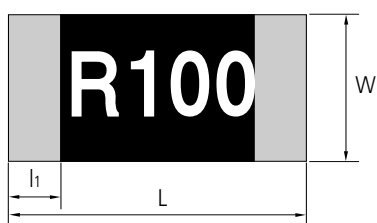

<Top View>



<Side View>

(UNIT: mm)

Type	Inch	Power(W)	L	W	H	l ₁	l ₂	Average Weight
RC1005	0402	1/16	1.00±0.05	0.50±0.05	0.35±0.05	0.20±0.10	0.25±0.10	0.6mg
RC1608	0603	1/10	1.60±0.10	0.80±0.10	0.45±0.10	0.30±0.20	0.35±0.10	2.1mg
RC2012	0805	1/8	2.00±0.20	1.25±0.15	0.50±0.10	0.40±0.20	0.35±0.20	4.9mg
RC3216	1206	1/4	3.20±0.20	1.60±0.15	0.55±0.10	0.45±0.20	0.40±0.20	9.5mg
RC3225	1210	1/3	3.20±0.20	2.55±0.20	0.55±0.10	0.45±0.20	0.40±0.20	16mg
RC5025	2010	2/3	5.00±0.20	2.50±0.20	0.55±0.10	0.60±0.20	0.60±0.20	26mg
RC6432	2512	1	6.30±0.20	3.20±0.20	0.55±0.10	0.60±0.20	0.60±0.20	41mg

Parts Numbering System

- The part number system shall be in the following format

RC	6432	J	R680	CS
Code Designation	Dimension & Size Code	Tolerance	Resistance Value	Packaging Code
RC: Chip Resistor	1005: 1.0×0.5(mm) - 0402(inch) 1608: 1.6×0.8(mm) - 0603(inch) 2012: 2.0×1.2(mm) - 0805(inch) 3216: 3.2×1.6(mm) - 1206(inch) 3225: 3.2×2.5(mm) - 1210(inch) 5025: 5.0×2.5(mm) - 2010(inch) 6432: 6.4×3.2(mm) - 2512(inch)	F: ±1% G: ±2% J: ±5%	3 or 4 digits coding system (E-24 series)	GS: Bulk Packaging CS: Tape Packaging 7" ES: Tape Packaging 10" AS: Tape Packaging 13"

Specification

Type	Power Rating (W)	Working Voltage (V, MAX)	TCR (ppm/°C)	Resistance Range (Ω)	Rated Ambient Temperature	Rated Working Temperature
RC1005	1/16	$\sqrt{P \times R}$	$0.1\Omega \leq R \leq 0.2\Omega$: +700, -600 $R > 0.2\Omega : \pm 250$	0.1~0.98	70°C	-55~+155°C
RC1608	1/10					
RC2012	1/8					
RC3216	1/4					
RC3225	1/3					
RC5025	2/3					
RC6432	1					

- Rated voltage (V) = $\sqrt{\text{Rated power(W)} \times \text{Normal resistance value (R)}}$
 Rated voltage should be lower than (MAX) working voltage.

Power Derating Curve

The rated power is the maximum continuous loading power at 70°C ambient temperature. For ambient temperature above 70°C, the loading power follows the below power derating curve.

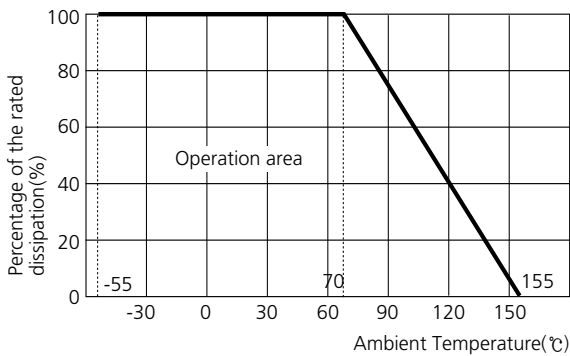

Marking

E-24 series

3 digits indication

- R means decimal point.
- Other digits represent significant value.
- Example: **R22**
 Left 1 digit: R
 Last 2 digits: 22
 $R22 = 0.22\Omega$



4 digits indication

- R means decimal point.
- Other digits represent significant value.
- Example: **R075**
 Left 1 digit: R
 Last 3 digits: 075
 $R075 = 0.075\Omega$



Resistance Value Table

- E-24 series

Code	R-value
R10	0.10 Ω
R11	0.11 Ω
R12	0.12 Ω
R13	0.13 Ω
R15	0.15 Ω
R16	0.16 Ω
R18	0.18 Ω
R20	0.20 Ω
R22	0.22 Ω
R24	0.24 Ω
R27	0.27 Ω
R30	0.30 Ω

Code	R-value
R33	0.33 Ω
R36	0.36 Ω
R39	0.39 Ω
R43	0.43 Ω
R47	0.47 Ω
R51	0.51 Ω
R56	0.56 Ω
R62	0.62 Ω
R68	0.68 Ω
R75	0.75 Ω
R82	0.82 Ω
R91	0.91 Ω

The specifications and designs contained herein may be subject to change without notice. Please contact our sales representatives or product engineers before order.

Operation Notes

Example of land Pattern Design

Recommended Soldering Conditions

General Structure

General

Precision

Jumper

Low ohms (RC Series)

Low ohms (RUT Series)

Ultra Low Ohms (RU Series)

Ultra Low Ohms (RUW Series)

Ultra Low Ohms (RUK Series)

Arrays (CONVEX Type)

Arrays (CONCAVE Type)

Arrays (FLAT Type)

Arrays for Memory Modules

Attenuator

Characteristics Performance

Packaging

Standard Resistance Value

Low Ohms(RUT Series)

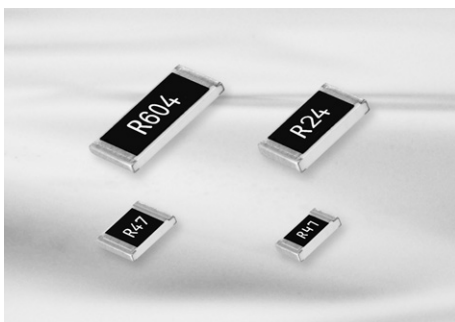

Feature

- Under 1 ohms, precision resistance.
- Both flow and reflow soldering are applicable.
- Ag metal is not used for termination electrode. (Good Sulfide - Resistant)
- The product of lead-free terminal is RoHS compliant. 100% Lead-free Products (PbO is not used)

Application

- Current detect.
- Safe circuit through protecting over-current flow.
- Power supplying part, DC power charger, adapter.
- Mobile Phone, HDD, DSC, LCD.

Structure and Dimensions

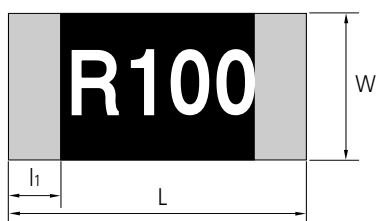

<Top View>



<Side View>

(UNIT: mm)

Type	Inch	Power(W)	L	W	H	l ₁	l ₂	Average Weight
RUT1005	0402	1/10 (0.1)	1.00±0.05	0.50±0.05	0.35±0.05	0.20±0.10	0.25±0.10	0.6mg
RUT1608	0603	1/8 (0.125)	1.60±0.10	0.80±0.10	0.45±0.10	0.30±0.20	0.35±0.10	2.1mg
RUT2012	0805	1/4 (0.25)	2.00±0.20	1.25±0.15	0.50±0.10	0.40±0.20	0.35±0.20	4.9mg
RUT3216	1206	1/3 (0.33)	3.20±0.20	1.60±0.15	0.55±0.10	0.45±0.20	0.40±0.20	9.5mg
RUT3225	1210	1/2 (0.50)	3.20±0.20	2.55±0.20	0.55±0.10	0.45±0.20	0.40±0.20	16mg
RUT5025	2010	2/3 (0.66)	5.00±0.20	2.50±0.20	0.55±0.10	0.60±0.20	0.60±0.20	26mg
RUT6432	2512	1 (1.0)	6.30±0.20	3.20±0.20	0.55±0.10	0.60±0.20	0.60±0.20	41mg

Parts Numbering System

- The part number system shall be in the following format

RUT	2012	J	R680	CS
Code Designation	Dimension & Size Code	Tolerance	Resistance Value	Packaging Code
RUT: Current Sensing Resistor Top Mounting (Face-up)	1005: 1.0×0.5(mm) - 0402(inch) 1608: 1.6×0.8(mm) - 0603(inch) 2012: 2.0×1.2(mm) - 0805(inch) 3216: 3.2×1.6(mm) - 1206(inch) 3225: 3.2×2.5(mm) - 1210(inch) 5025: 5.0×2.5(mm) - 2010(inch) 6432: 6.4×3.2(mm) - 2512(inch)	F: ±1% G: ±2% J: ±5%	3 or 4 digits coding system (IEC coding system) 3digits(E-24 series) 4digits(E-96 series)	GS: Bulk Packaging CS: Tape Packaging 7" ES: Tape Packaging 10" AS: Tape Packaging 13"

Specification

Type	Power Rating (W)	Working Voltage (V, MAX)	TCR (ppm/°C)	Resistance Range (Ω)	Rated Ambient Temperature	Rated Working Temperature
RUT1005	1/10 (0.1)	$\sqrt{P \times R}$	±150	0.1~0.98	70°C	-55~+155°C
RUT1608	1/8 (0.125)					
RUT2012	1/4 (0.25)					
RUT3216	1/3 (0.33)					
RUT3225	1/2 (0.50)					
RUT5025	2/3 (0.66)					
RUT6432	1 (1.0)					

- Rated voltage (V) = $\sqrt{\text{Rated power(W)} \times \text{Normal resistance value (R)}}$
Rated voltage should be lower than (MAX) working voltage.

Power Derating Curve

The rated power is the maximum continuous loading power at 70°C ambient temperature. For ambient temperature above 70°C, the loading power follows the below power derating curve.

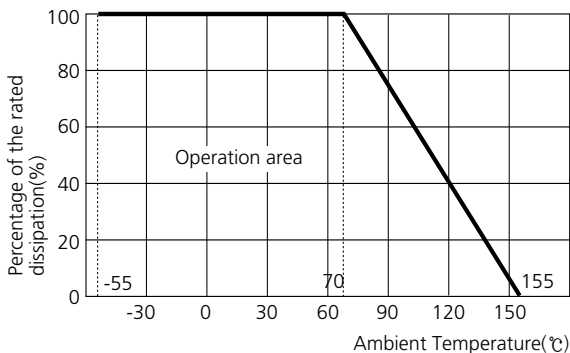

Marking

E-24 series

3 digits indication

- R means decimal point.
- Other digits represent significant value.
- Example: **R22**
Left 1 digit: R
Last 2 digits: 22
R22 = 0.22 Ω



4 digits indication

- R means decimal point.
- Other digits represent significant value.
- Example: **R075**
Left 1 digit: R
Last 3 digits: 075
R075 = 0.075 Ω



Resistance Value Table

Code	Value (Ω)	Tol (%)	Code	Value (Ω)	Tol (%)	Code	Value (Ω)	Tol (%)	Code	Value (Ω)	Tol (%)	Code	Value (Ω)	Tol (%)	Code	Value (Ω)	Tol (%)
R100	0.1	±1, ±5	R154	0.154	±1	R226	0.226	±1	R330	0.33	±1, ±5	R470	0.47	±1, ±5	R680	0.68	±1, ±5
R102	0.102	±1	R158	0.158	±1	R232	0.232	±1	R332	0.332	±1	R475	0.475	±1	R681	0.681	±1
R105	0.105	±1	R160	0.16	±1, ±5	R237	0.237	±1	R340	0.34	±1	R487	0.487	±1	R698	0.698	±1
R107	0.107	±1	R162	0.162	±1	R240	0.24	±1, ±5	R348	0.348	±1	R499	0.499	±1	R715	0.715	±1
R110	0.11	±1, ±5	R165	0.165	±1	R243	0.243	±1	R357	0.357	±1	R510	0.51	±1, ±5	R732	0.732	±1
R113	0.113	±1	R169	0.169	±1	R249	0.249	±1	R360	0.36	±1, ±5	R511	0.511	±1	R750	0.75	±1, ±5
R115	0.115	±1	R174	0.174	±1	R255	0.255	±1	R365	0.365	±1	R523	0.523	±1	R768	0.768	±1
R118	0.118	±1	R178	0.178	±1	R261	0.261	±1	R374	0.374	±1	R536	0.536	±1	R787	0.787	±1
R120	0.12	±1, ±5	R180	0.180	±1, ±5	R267	0.267	±1	R383	0.383	±1	R549	0.549	±1	R806	0.806	±1
R121	0.121	±1	R182	0.182	±1	R270	0.27	±1, ±5	R390	0.39	±1, ±5	R560	0.56	±1, ±5	R820	0.82	±1, ±5
R124	0.124	±1	R187	0.187	±1	R274	0.274	±1	R392	0.392	±1	R562	0.562	±1	R825	0.825	±1
R127	0.127	±1	R191	0.191	±1	R280	0.28	±1	R402	0.402	±1	R576	0.576	±1	R845	0.845	±1
R130	0.13	±1, ±5	R196	0.196	±1	R287	0.287	±1	R412	0.412	±1	R590	0.59	±1	R866	0.866	±1
R133	0.133	±1	R200	0.200	±1, ±5	R294	0.294	±1	R422	0.422	±1	R604	0.604	±1	R887	0.887	±1
R137	0.137	±1	R205	0.205	±1	R300	0.3	±1, ±5	R430	0.43	±1, ±5	R619	0.619	±1	R909	0.909	±1
R140	0.14	±1	R210	0.21	±1	R301	0.301	±1	R432	0.432	±1	R620	0.62	±1, ±5	R910	0.91	±1, ±5
R143	0.143	±1	R215	0.215	±1	R309	0.309	±1	R442	0.442	±1	R634	0.634	±1	R931	0.931	±1
R147	0.147	±1	R220	0.22	±1, ±5	R316	0.316	±1	R453	0.453	±1	R649	0.649	±1	R953	0.953	±1
R150	0.15	±1, ±5	R221	0.221	±1	R24	0.324	±1	R464	0.464	±1	R665	0.665	±1	R976	0.976	±1

The specifications and designs contained herein may be subject to change without notice. Please contact our sales representatives or product engineers before order.

Operation Notes

Example of land Pattern Design

Recommended Soldering Conditions

General Structure

General

Precision

Jumper

Low ohms (RC Series)

Low ohms (RUT Series)

Ultra Low Ohms (RU Series)

Ultra Low Ohms (RUW Series)

Ultra Low Ohms (RUK Series)

Arrays (CONVEX Type)

Arrays (CONCAVE Type)

Arrays (FLAT Type)

Arrays for Memory Modules

Attenuator

Characteristics Performance

Packaging

Standard Resistance Value

Ultra Low Ohms(RU Series)

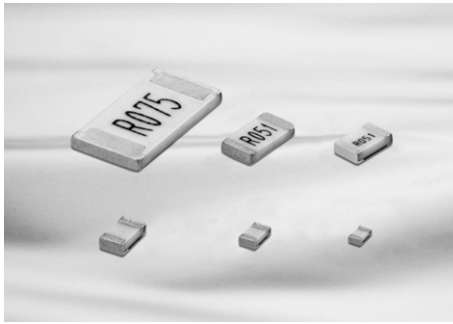

Feature

- Ultra Low Ohms Resistor, high precision reliability
- Suitable for reflow and soldering.
- Reverse Type.
- Ag metal is not used for termination electrode.
(Good Sulfide-Resistant)
- 100% Lead-free Products (PbO is not used)
- RoHS Compliant.

Application

- Current Sensings.
- Safe circuit through protecting over current flow.
- Power supplying part, DC power charger, adapter.
- Mobile Phone, Mobile PC, Note PC, HDD, DSC, LCD

Structure and Dimensions

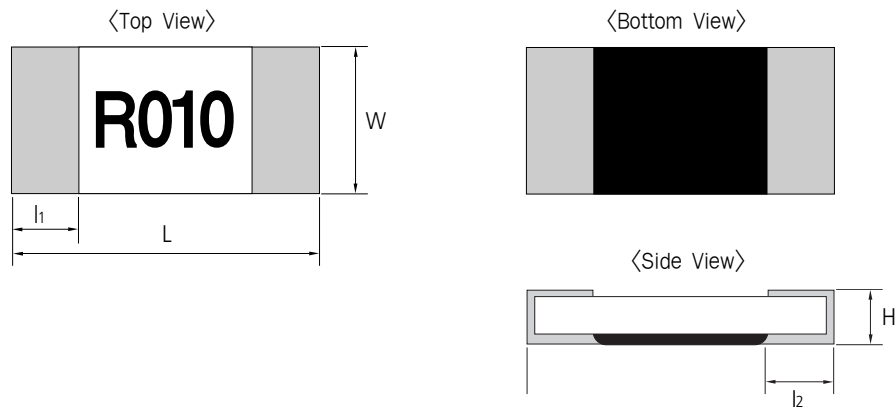

(UNIT: mm)

Type	Inch	Power(W)	L	W	H	l ₁	l ₂	Average Weight
RU1005	0402	1/8 (0.125)	1.00±0.05	0.50±0.05	0.35±0.05	0.25±0.15	0.25±0.15	0.6mg
RU1608	0603	1/4 (0.25)	1.60±0.10	0.80±0.10	0.45±0.10	0.30±0.20	R < 0.03 Ω : 0.50±0.20 R ≥ 0.03 Ω : 0.35±0.20	2.2mg
RU2012	0805	1/3 (0.33)	2.00±0.20	1.25±0.15	0.55±0.10	0.40±0.20	R < 0.03 Ω : 0.65±0.20 R ≥ 0.03 Ω : 0.40±0.20	4.7mg
RU3216	1206	1/2 (0.5)	3.20±0.20	1.60±0.15	0.60±0.10	0.45±0.20	R < 0.03 Ω : 0.90±0.20 R ≥ 0.03 Ω : 0.60±0.20	9.4mg
RU3225	1210	2/3 (0.66)	3.20±0.20	2.55±0.20	0.55±0.10	0.45±0.20	R < 0.03 Ω : 1.2±0.20 R ≥ 0.03 Ω : 0.75±0.20	9.5mg
RU5025	2010	3/4 (0.75)	5.00±0.20	2.50±0.20	0.60±0.10	0.80±0.20	R < 0.03 Ω : 1.5±0.20 R ≥ 0.03 Ω : 0.90±0.20	27mg
RU6432	2512	1 (1.0)	6.30±0.20	3.20±0.20	0.60±0.10	1.00±0.20	R < 0.03 Ω : 1.90±0.20 R ≥ 0.03 Ω : 1.10±0.25	42mg

Parts Numbering System

- The part number system shall be in the following format

RU	2012	F	R051	CS
Code Designation	Dimension & Size Code	Tolerance	Resistance Value	Packaging Code
RU : Current sensing resistor	1005: 1.0×0.5(mm) - 0402(inch)	F: ±1% G: ±2% J: ±5%	3 or 4 digits coding system (E-24 series)	CS: Tape Packaging 7"
	1608: 1.6×0.8(mm) - 0603(inch)			ES: Tape Packaging 10"
	2012: 2.0×1.2(mm) - 0805(inch)			AS: Tape Packaging 13"
	3216: 3.2×1.6(mm) - 1206(inch)			
	3225: 3.2×2.5(mm) - 1210(inch)			
	5025: 5.0×2.5(mm) - 2010(inch)			
6432: 6.4×3.2(mm) - 2512(inch)				

Specification

Type	Power Rating (W)	Working Voltage (V, MAX)	Tolerance (%)	Resistance Range (Ω)	T.C.R (ppm/ $^{\circ}$ C)	Rated Ambient Temperature	Rated Working Temperature
RU1005	1/8 (0.125)	$\sqrt{P \times R}$	F: ± 1 J: ± 5	25m~100m	R < 47m: ± 500 R \geq 47m: ± 150	70 $^{\circ}$ C	-55 $^{\circ}$ C ~ +155 $^{\circ}$ C
RU1608	1/4 (0.25)			10m~100m	R \leq 25m: ± 600 R < 33m: ± 400 R \geq 33m: ± 150		
RU2012	1/3 (0.33)				R \leq 25m: ± 500 R < 33m: ± 350 R \geq 33m: ± 150		
RU3216	1/2 (0.5)						
RU3225	2/3 (0.66)						
RU5025	3/4 (0.75)						
RU6432	1 (1)						

- Working voltage = Rated voltage(Vr)=(P \times R) (P:Rated Power, R:Nominal Resistance)
Please contact our sales representatives or product engineers for lower T.C.R or higher rated power products.

Power Derating Curve

The rated power is the maximum continuous loading power at 70 $^{\circ}$ C ambient temperature. For ambient temperature above 70 $^{\circ}$ C, the loading power follows the below power derating curve.

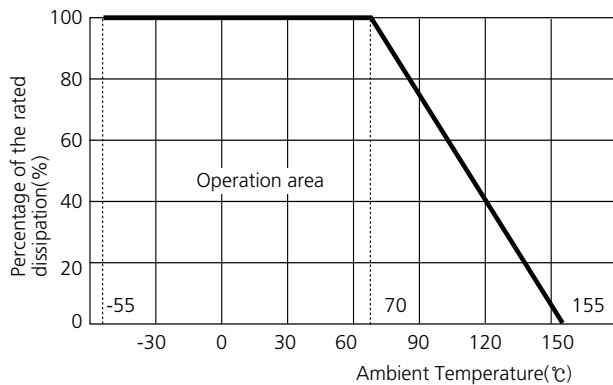

Marking

4 digits indication (E-24 series)

- R means decimal point.
- Other digits represent significant value.
- Example: **R010**
Left 1 digit: R
Last 3 digits: **010**
R010 = 0.010 Ω = 10m Ω



Performance Characteristics

Item	Requirement dR%	Test Method
Resistance	within specified tolerance	at 25 $^{\circ}$ C. Kelvin Probing Method.
T.C.R	within specified T.C.R	20 $^{\circ}$ C/-55 $^{\circ}$ C & 20 $^{\circ}$ C/+125 $^{\circ}$ C
Overload(Short time)	$\pm(1.0\%+0.0005 \Omega)$	Rated Voltage \times 2.5 for 5sec.
Overload(Intermittent)	$\pm(3.0\%+0.0005 \Omega)$	Rated Voltage \times 2.5 1sec on, 25sec off 10,000cycles.
Resistance to solder Heat	$\pm(1.0\%+0.0005 \Omega)$	260 $^{\circ}$ C \pm 5 $^{\circ}$ C, 10 \pm 1sec
Moisture Resistance	$\pm(3.0\%+0.0005 \Omega)$	40 $^{\circ}$ C, 95%RH, 1,000hr, 1.5hr On/0.5hr off cycle
Endurance at 70 $^{\circ}$ C	$\pm(3.0\%+0.0005 \Omega)$	70 $^{\circ}$ C, 1,000hr, 1.5hr On/0.5hr off cycle
Bending strength	$\pm(1.0\%+0.0005 \Omega)$	60mm/min speed, Press until 3mm, keep 5sec

The specifications and designs contained herein may be subject to change without notice. Please contact our sales representatives or product engineers before order.

Operation Notes

Example of land Pattern Design

Recommended Soldering Conditions

General Structure

General

Precision

Jumper

Low ohms (RC Series)

Low ohms (RUT Series)

Ultra Low Ohms (RU Series)

Ultra Low Ohms (RUW Series)

Ultra Low Ohms (RUK Series)

Arrays (CONVEX Type)

Arrays (CONCAVE Type)

Arrays (FLAT Type)

Arrays for Memory Modules

Attenuator

Characteristics Performance

Packaging

Standard Resistance Value

Ultra Low Ohms(RUW Series)

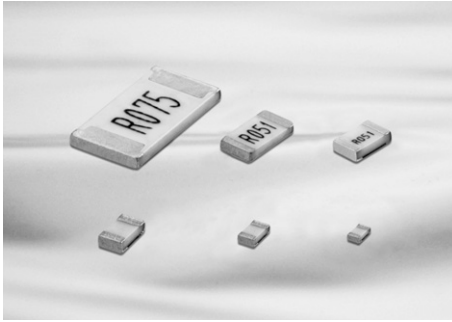

Feature

- Ultra Low Ohms Resistor, high precision reliability
- Suitable for reflow and soldering.
- Very stable Temperature coefficient characteristics.
- Reverse Type.
- Ag metal is not used for termination electrode (Good Sulfide -Resistant)
- 100% Lead-free Products (PbO is not used)
- RoHS Compliant.

Application

- Current Sensings.
- Safe circuit through protecting over current flow.
- Power supplying part, DC power charger, adapter.
- Mobile Phone, Mobile PC, Note PC, HDD, DSC, LCD

Structure and Dimensions

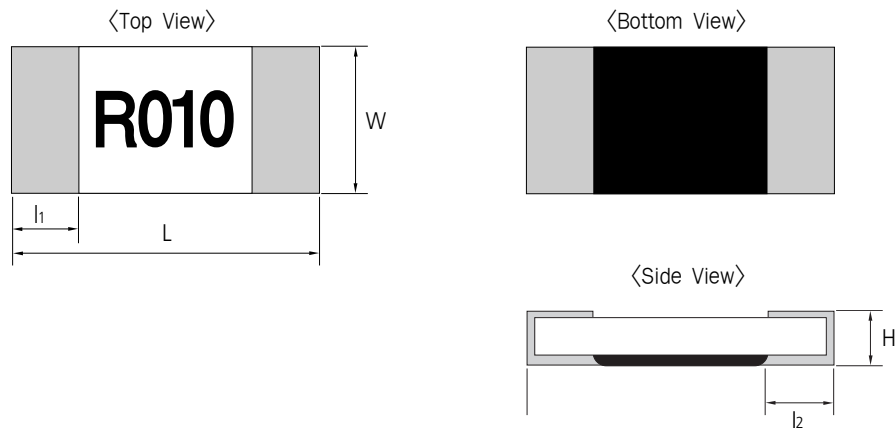

(UNIT: mm)

Type	Inch	Power(W)	L	W	H	l ₁	l ₂	Average Weight
RUW1608	0603	1/3 (0.33)	1.60±0.10	0.80±0.10	0.45±0.10	0.30±0.20	R < 0.03 Ω : 0.50±0.20 R ≥ 0.03 Ω : 0.35±0.20	2.2mg
RUW2012	0805	1/2 (0.5)	2.00±0.20	1.25±0.15	0.55±0.10	0.40±0.20	R < 0.03 Ω : 0.65±0.20 R ≥ 0.03 Ω : 0.40±0.20	4.7mg
RUW3216	1206	1 (1)	3.20±0.20	1.60±0.15	0.60±0.10	0.45±0.20	R < 0.03 Ω : 0.90±0.20 R ≥ 0.03 Ω : 0.60±0.20	9.4mg

Parts Numbering System

- The part number system shall be in the following format

RUK	2012	F	R010	CS
Code Designation	Dimension & Size Code	Tolerance	Resistance Value	Packaging Code
RUW : Current Sensing Resistor High Power	1608: 1.6×0.8(mm) - 0603(inch) 2012: 2.0×1.2(mm) - 0805(inch) 3216: 3.2×1.6(mm) - 1206(inch)	F: ±1% G: ±2% J: ±5%	3 or 4 digits coding system (IEC coding system) 3digits(E-24 series) 4digits(E-96 series)	GS: Bulk Packaging CS: Tape Packaging 7" ES: Tape Packaging 10" AS: Tape Packaging 13"

Specification

Type	Power Rating (W)	Working Voltage (Vr)	Tolerance (%)	Resistance Range (Ω)	T.C.R (ppm/ $^{\circ}$ C)	Rated Ambient Temperature	Rated Working Temperature
RUW1608	1/3 (0.33)	$\sqrt{P \times R}$	F: ± 1 J: ± 5	10m~100m	R \leq 25m: ± 600 R<33m: ± 400 R \geq 33m: ± 150	70 $^{\circ}$ C	-55 $^{\circ}$ C~+155 $^{\circ}$ C
RUW2012	1/2 (0.5)		F: ± 1 J: ± 5		R<25m: ± 600 R<33m: ± 400 R \geq 33m: ± 150		
RUW3216	1 (1)		F: ± 1 J: ± 5		R<25m: ± 500 R<33m: ± 350 R \geq 33m: ± 150		

- Working voltage = Rated voltage(Vr)=(P \times R) (P:Rated Power, R:Nominal Resistance)
Please contact our sales representatives or product engineers for lower T.C.R or higher rated power products.

Power Derating Curve

The rated power is the maximum continuous loading power at 70 $^{\circ}$ C ambient temperature. For ambient temperature above 70 $^{\circ}$ C, the loading power follows the below power derating curve.

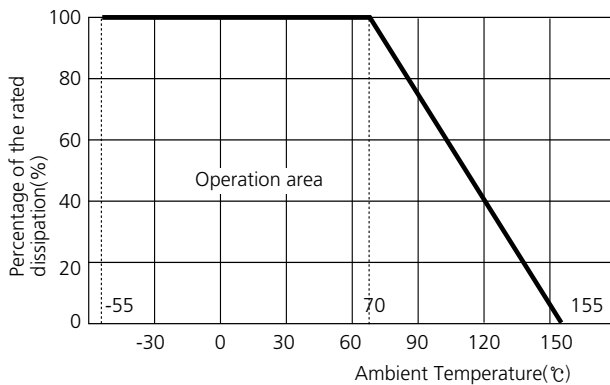

Marking

4 digits indication (E-24 series)

- R means decimal point.
- Other digits represent significant value.
- Example: **R010**
Left 1 digit: R
Last 3 digits: **010**
R010 = 0.010 Ω = 10m Ω



Performance Characteristics

Item	Requirement dR%	Test Method
Resistance	within specified tolerance	at 25 $^{\circ}$ C. Kelvin Probing Method.
T.C.R	within specified T.C.R	20 $^{\circ}$ C/-55 $^{\circ}$ C & 20 $^{\circ}$ C/+125 $^{\circ}$ C
Overload(Short time)	$\pm(1.0\%+0.0005 \Omega)$	Rated Voltage \times 2.5 for 5sec.
Overload(Intermittent)	$\pm(3.0\%+0.0005 \Omega)$	Rated Voltage \times 2.5 1sec on, 25sec off 10,000cycles.
Resistance to solder Heat	$\pm(1.0\%+0.0005 \Omega)$	260 $^{\circ}$ C \pm 5 $^{\circ}$ C, 10 \pm 1sec
Moisture Resistance	$\pm(3.0\%+0.0005 \Omega)$	40 $^{\circ}$ C, 95%RH, 1,000hr, 1.5hr On/0.5hr off cycle
Endurance at 70 $^{\circ}$ C	$\pm(3.0\%+0.0005 \Omega)$	70 $^{\circ}$ C, 1,000hr, 1.5hr On/0.5hr off cycle
Bending strength	$\pm(1.0\%+0.0005 \Omega)$	60mm/min speed, Press until 3mm, keep 5sec

The specifications and designs contained herein may be subject to change without notice. Please contact our sales representatives or product engineers before order.

Operation Notes

Example of land Pattern Design

Recommended Soldering Conditions

General Structure

General

Precision

Jumper

Low ohms (RC Series)

Low ohms (RUT Series)

Ultra Low Ohms (RU Series)

Ultra Low Ohms (RUW Series)

Ultra Low Ohms (RUK Series)

Arrays (CONVEX Type)

Arrays (CONCAVE Type)

Arrays (FLAT Type)

Arrays for Memory Modules

Attenuator

Characteristics Performance

Packaging

Standard Resistance Value

Ultra Low Ohms(RUK Series)

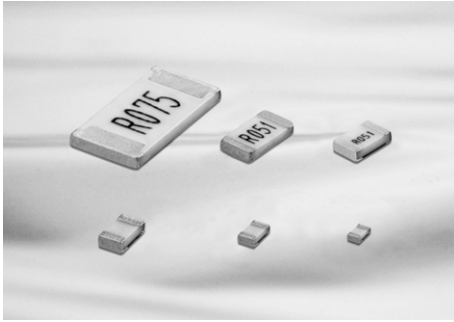

Feature

- Ultra Low Ohms Resistor, high precision reliability
- Suitable for reflow and soldering.
- Very stable Temperature coefficient characteristics.
- Reverse Type.
- Ag metal is not used for termination electrode. (Good Sulfide -Resistant)
- 100% Lead-free Products (PbO is not used)
- RoHS Compliant.

Application

- Current Sensings.
- Safe circuit through protecting over current flow.
- Power supplying part, DC power charger, adapter.
- Mobile Phone, Mobile PC, Note PC, HDD, DSC, LCD

Structure and Dimensions

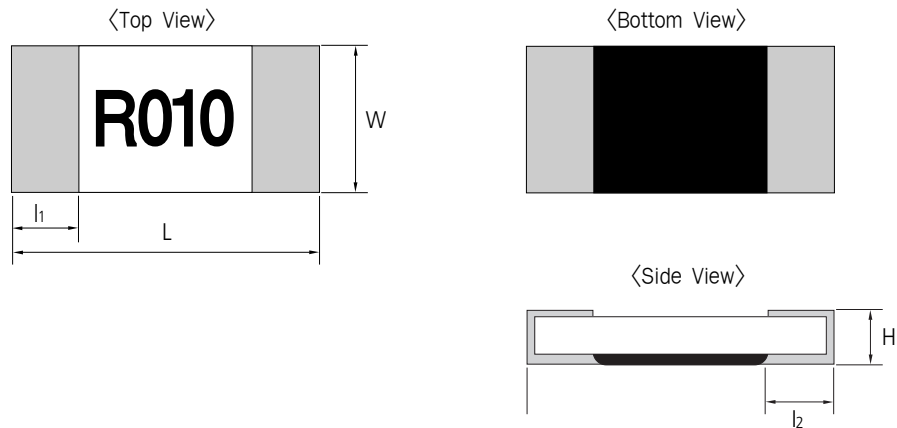

(UNIT: mm)

Type	Inch	Power(W)	L	W	H	l ₁	l ₂	Average Weight
RUK1608	0603	1/3 (0.33)	1.60±0.10	0.80±0.10	0.45±0.10	0.35±0.20	0.50±0.20	2.2mg
RUK2012	0805	1/2 (0.50)	2.00±0.10	1.25±0.10	0.55±0.10	0.40±0.20	0.65±0.20	4.7mg
RUK3216	1206	1 (1.0)	3.20±0.25	1.60±0.15	R≤0015Ω:0.70±0.10 R>0015Ω:0.60±0.10	0.45±0.20	0.90±0.20	9.4mg
RUK3225	1210	1 (1.0)	3.20±0.20	2.55±0.20	0.60±0.10	0.45±0.20	0.80±0.20	9.5mg
RUK5025	2010	1 (1.0)	5.00±0.20	2.50±0.20	0.65±0.10	0.80±0.20	1.10±0.20	27mg
RUK6432	2512	1 (1.0)	6.30±0.20	3.20±0.20	0.65±0.10	1.0±0.20	1.90±0.20	42mg

Parts Numbering System

- The part number system shall be in the following format

RUK	1608	F	R010	CS
Code Designation	Dimension & Size Code	Tolerance	Resistance Value	Packaging Code
RUK : Current Sensing Resistor Low TCR	1608: 1.6×0.8(mm) - 0603(inch) 2012: 2.0×1.2(mm) - 0805(inch) 3216: 3.2×1.6(mm) - 1206(inch) 3225: 3.2×2.5(mm) - 1210(inch) 5025: 5.0×2.5(mm) - 2010(inch) 6432: 6.4×3.2(mm) - 2512(inch)	F: ±1% G: ±2% J: ±5%	3 or 4 digits coding system (IEC condong system) 3digits(E-24 series) 4digits(E-96 series)	GS: Bulk Packaging CS: Tape Packaging 7" ES: Tape Packaging 10" AS: Tape Packaging 13"

Specification

Type	Power Rating (W)	Working Voltage (Vr)	Tolerance (%)	Resistance Range (Ω)	T.C.R (ppm/°C)	Rated Ambient Temperature	Rated Working Temperature
RUK1608	1/3 (0.33)	$\sqrt{P \times R}$	F: ±1 J: ±5	10m~30m	±100	70°C	-55°C ~ +155°C
RUK2012	1/2 (0.50)						
RUK3216	1 (1.0)						
RUK3225	1 (1.0)						
RUK5025	1 (1.0)						
RUK6432	1 (1.0)						

- Working voltage = Rated voltage(Vr)=(P × R) (P:Rated Power, R:Nominal Resistance)
Please contact our sales representatives or product engineers for lower T.C.R or higher rated power products.

Power Derating Curve

The rated power is the maximum continuous loading power at 70°C ambient temperature. For ambient temperature above 70°C, the loading power follows the below power derating curve.

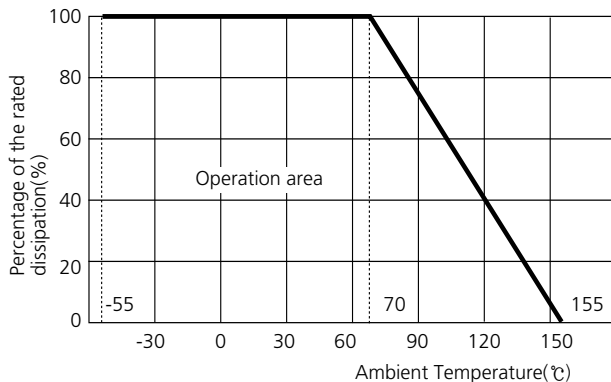

Marking

4 digits indication (E-24 series)

- R means decimal point.
- Other digits represent significant value.
- Example: **R010**
Left 1 digit: R
Last 3 digits: 010
 $R010 = 0.010 \Omega = 10m\Omega$



Performance Characteristics

Item	Requirement dR%	Test Method
Resistance	within specified tolerance	at 25°C. Kelvin Probing Method.
T.C.R	within specified T.C.R	20°C/-55°C & 20°C/+125°C
Overload(Short time)	±(1.0%+0.0005 Ω)	Rated Voltage × 2.5 for 5sec.
Overload(Intermittent)	±(3.0%+0.0005 Ω)	Rated Voltage × 2.5 1sec on, 25sec off 10,000cycles.
Resistance to solder Heat	±(1.0%+0.0005 Ω)	260°C±5°C, 10±1sec
Moisture Resistance	±(3.0%+0.0005 Ω)	40°C, 95%RH, 1,000hr, 1.5hr On/0.5hr off cycle
Endurance at 70°C	±(3.0%+0.0005 Ω)	70°C, 1,000hr, 1.5hr On/0.5hr off cycle
Bending strength	±(1.0%+0.0005 Ω)	60mm/min speed, Press until 3mm, keep 5sec

The specifications and designs contained herein may be subject to change without notice. Please contact our sales representatives or product engineers before order.

Operation Notes

Example of land Pattern Design

Recommended Soldering Conditions

General Structure

General

Precision

Jumper

Low ohms (RC Series)

Low ohms (RUT Series)

Ultra Low Ohms (RU Series)

Ultra Low Ohms (RUW Series)

Ultra Low Ohms (RUK Series)

Arrays (CONVEX Type)

Arrays (CONCAVE Type)

Arrays (FLAT Type)

Arrays for Memory Modules

Attenuator

Characteristics Performance

Packaging

Standard Resistance Value

Arrays(Convex Type)

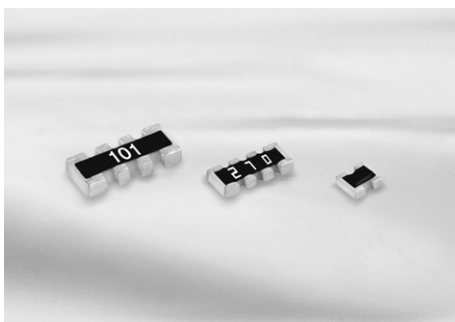

Feature

- Reducing SMD surface area (40% reduced).
- Reducing SMD costs (75% reduced).
- Both flow and reflow soldering are applicable.
- Convex & concave type.

The product of lead-free terminal is RoHS compliant.
PhO(lead oxide) is included in the glass of our product which is prescribed on RoHS appendix as an exception.

Application

- For semiconductor devices.
- For computers, digital circuits.

Structure and Dimensions

• 2 Array

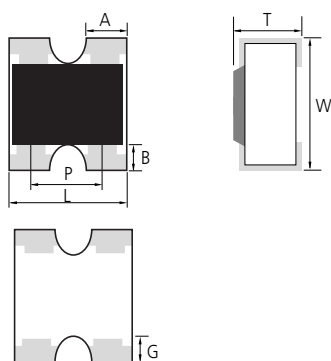

• 4 Array

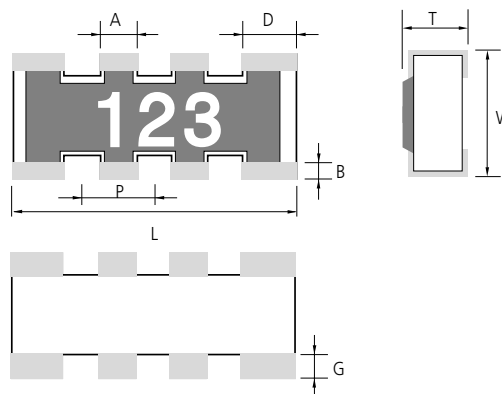

(UNIT: mm)

Type	L	W	T	A	D	B	G	P	Average Weight
RP102P	1.00±0.10	1.00±0.10	0.35±0.10	0.33±0.05	-	0.20±0.10	0.25±0.10	0.65±0.10	1.1mg
RP104P	2.00±0.10	1.00±0.10	0.35±0.10	0.30±0.15	0.40±0.15	0.15±0.10	0.25±0.15	0.50±0.15	2.2mg
RP164P	3.20±0.10	1.60±0.10	0.50±0.10	0.40±0.15	0.60±0.15	0.30±0.15	0.30±0.15	0.80±0.15	8.9mg

Parts Numbering System

• The part number system shall be in the following format

RP	10	4P	J	100	FS
Code Designation	Dimension	Resistors	Tolerance	Resistance Value	Packaging Code
RP: Convex type array	10: 1005	2P: 2 Pieces 4P: 4 Pieces	J: ±5% * Jumper: 'J'	3 digit coding system (IEC coding system) E-24 series	CS : Tape Packaging 7" ES : Tape Packaging 10" AS : Tape Packaging 13"

Specification

Type	Power Rating (W)	Working Voltage (MAX)	Overload Voltage (MAX)	TCR (ppm/°C)	Resistance Range (Ω)	Rated Ambient Temperature	Rated Working Temperature
102P	1/16	25(V)	50(V)	±200	1Ω~1MΩ	70°C	-55°C~+155°C
104P		25(V)	50(V)				
164P		50(V)	100(V)				

• Rated voltage (V) = $\sqrt{\text{Rated power(W)} \times \text{Normal resistance value (R)}}$
Rated voltage should be lower than (MAX) working voltage.

Power Derating Curve

The rated power is the maximum continuous loading power at 70°C ambient temperature.
For ambient temperature above 70°C, the loading power follows the below power derating curve.
(The load current shall be derated according to Derating curve in case of the 'Jumper')

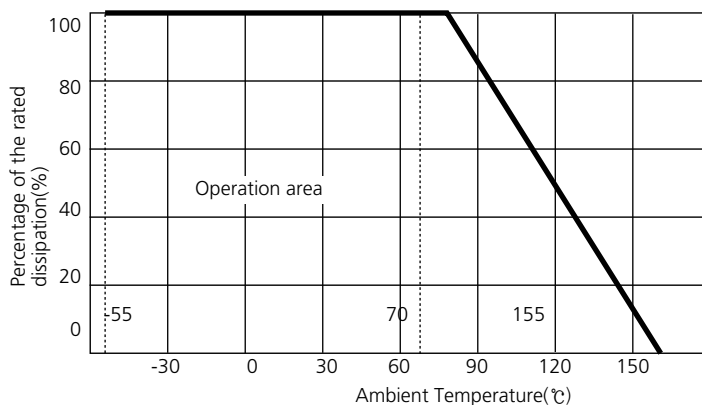

Jumper Resistors

Type	Resistance	Current Rating	Rated Ambient Temperature	Rated Working Temperature
102P	50mΩ Max.	1.0(A)	70°C	-55°C ~ +155°C
104P				
164P				

Marking

- 3 digits indication(E-24 series)
 - Left 2 digits represent significant figures.
 - Last 1 digit represents exponential number of 10.
 - Example: 103
 - Left 2 digit: 10
 - Last 1 digit: 3
 - $103 = 10 \times 10^3 = 10000 \Omega = 10k\Omega$
- RP102P, RN102P, RN104P type : No marking.

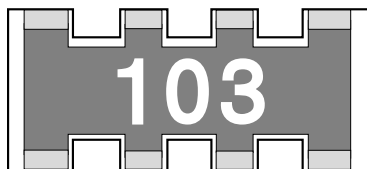

* Jumper chip is printed as "000".

Land Pattern

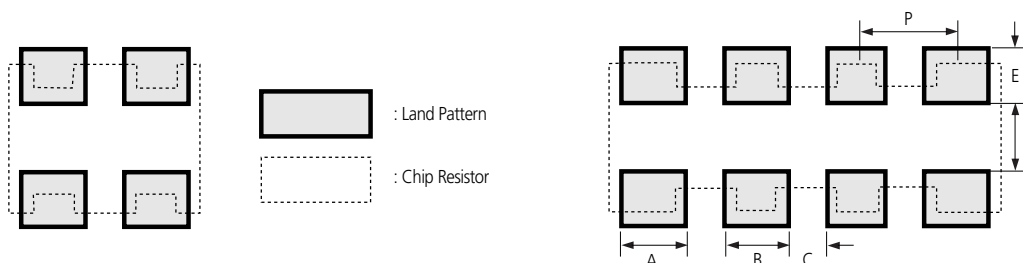

Type	A	B	C	D	E	P ₁	P ₂
10AT	0.4	0.4	0.25	0.5	0.5	0.65	-
102P	0.4	0.4	0.25	0.5	0.5	0.65	-
104P	0.7	0.3	0.2	0.5	0.5	0.55	0.5
164P	0.7	0.5	0.3	0.9	0.8	0.9	0.8

The specifications and designs contained herein may be subject to change without notice.
Please contact our sales representatives or product engineers before order.

Operation Notes

Example of land Pattern Design

Recommended Soldering Conditions

General Structure

General

Precision

Jumper

Low ohms (RC Series)

Low ohms (RUT Series)

Ultra Low Ohms (RU Series)

Ultra Low Ohms (RUW Series)

Ultra Low Ohms (RUK Series)

Arrays (CONVEX Type)

Arrays (CONCAVE Type)

Arrays (FLAT Type)

Arrays for Memory Modules

Attenuator

Characteristics Performance

Packaging

Standard Resistance Value

Arrays (Concave Type)

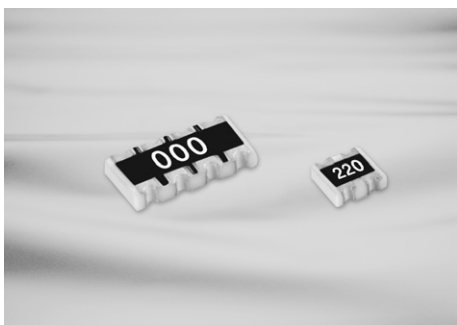

Feature

- Reducing SMD surface area (40% reduced).
- Reducing SMD costs (75% reduced).
- Both flow and reflow soldering are applicable.
- Convex & concave type.

The product of lead-free terminal is RoHS compliant. PhO(lead oxide) is included in the glass of our product which is prescribed on RoHS appendix as an exception.

Application

- For semiconductor devices.
- For computers, digital circuits.

Structure and Dimensions

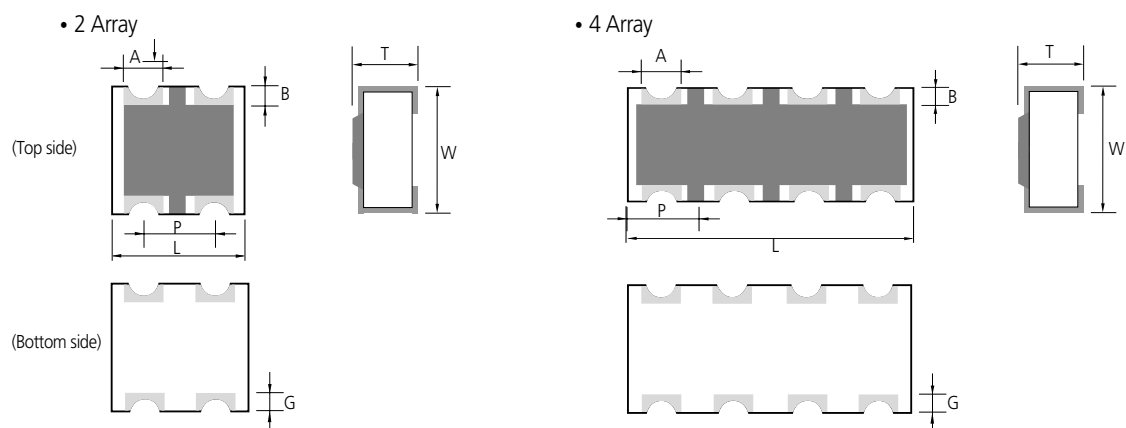

(UNIT: mm)

Type	L	W	T	A	B	G	P	Average Weight
RN102P	1.00±0.10	1.00±0.10	0.35±0.10	0.30±0.10	0.15±0.10	0.25±0.15	0.5±0.10	1.2mg
RN104P	2.00±0.10	1.00±0.10	0.40±0.10	0.30±0.10	0.15±0.10	0.25±0.15	0.5±0.10	2.8mg

Parts Numbering System

- The part number system shall be in the following format

RN	10	4P	J	100	CS
Code Designation	Dimension	Resistors	Tolerance	Resistance Value	Packaging Code
RN: Concave type array	10: 1005	2P: 2 Pieces 4P: 4 Pieces	F: ±1% J: ±5% * Jumper: 'J'	3 digit coding system (IEC coding system) E-24 series	CS : Tape Packaging 7" ES : Tape Packaging 10" AS : Tape Packaging 13"

Specification

Type	Power Rating (W)	Working Voltage (MAX)	Overload Voltage (MAX)	TCR (ppm/°C)	Resistance Range (Ω)	Rated Ambient Temperature	Rated Working Temperature
102P	1/16	25(V)	50(V)	1~9.9 Ω: ±300	1 Ω~1MΩ	70°C	-55°C~+155°C
104P		25(V)	50(V)	10 Ω~1MΩ: ±200			

• Rated voltage (V) = $\sqrt{\text{Rated power(W)} \times \text{Normal resistance value (R)}}$
 Rated voltage should be lower than (MAX) working voltage.

Power Derating Curve

The rated power is the maximum continuous loading power at 70°C ambient temperature.
 For ambient temperature above 70°C, the loading power follows the below power derating curve.
 (The load current shall be derated according to Derating curve in case of the 'Jumper')

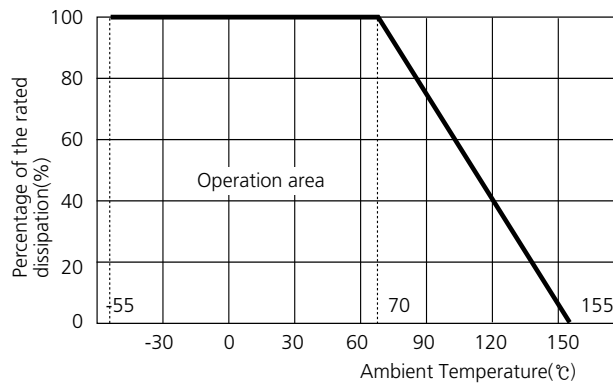

Jumper Resistors

Type	Resistance	Current Rating	Rated Ambient Temperature	Rated Working Temperature
102P 104P	50mΩ Max.	1.0(A)	70°C	-55°C~+155°C

Land Pattern

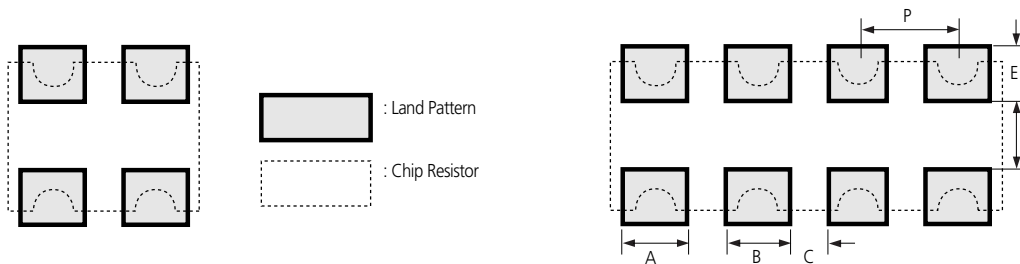

Type	A	B	C	D	E	P
102P	0.3	0.3	0.2	0.5	0.4	0.5
104P	0.3	0.3	0.2	0.5	0.4	0.5

The specifications and designs contained herein may be subject to change without notice.
 Please contact our sales representatives or product engineers before order.

Operation Notes

Example of land Pattern Design

Recommended Soldering Conditions

General Structure

General

Precision

Jumper

Low ohms (RC Series)

Low ohms (RUT Series)

Ultra Low Ohms (RU Series)

Ultra Low Ohms (RUW Series)

Ultra Low Ohms (RUK Series)

Arrays (CONVEX Type)

Arrays (CONCAVE Type)

Arrays (FLAT Type)

Arrays for Memory Modules

Attenuator

Characteristics Performance

Packaging

Standard Resistance Value

Arrays(Flat Type)

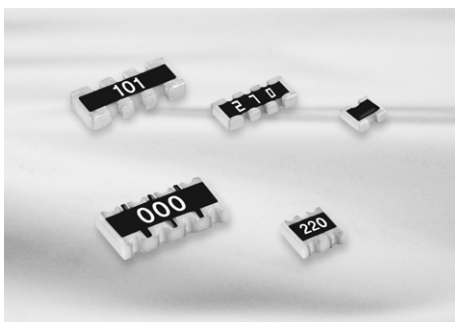

Feature

- Reducing SMD surface area (40% reduced).
- Reducing SMD costs (75% reduced).
- Both flow and reflow soldering are applicable.
- Convex & concave type.

The product of lead-free terminal is RoHS compliant.
PhO(lead oxide) is included in the glass of our product which is prescribed on RoHS appendix as an exception.

Application

- For semiconductor devices.
- For computers, digital circuits.

Structure and Dimensions

• 2 Array

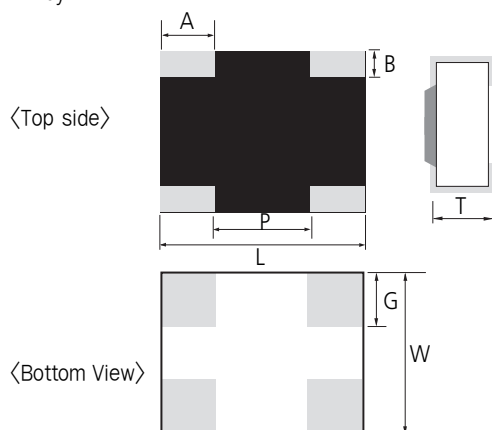

• 4 Array

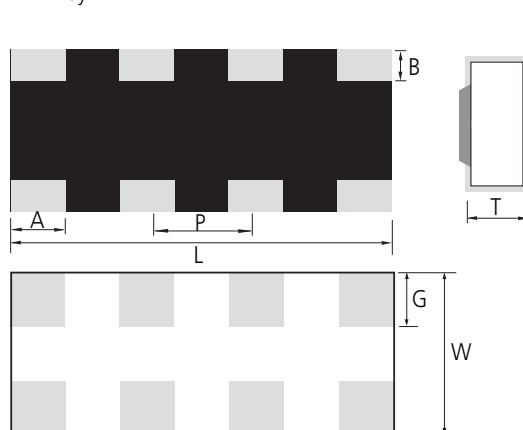

(UNIT: mm)

Type	L	W	T	A	B	G	P	Average Weight
RF062P	0.80±0.05	0.60±0.05	0.23±0.10	0.20±0.10	0.10±0.10	0.20±0.10	0.50±0.05	0.3mg
RF064P	1.40±0.05	0.60±0.05	0.23±0.10	0.20±0.10	0.10±0.10	0.20±0.10	0.40±0.05	0.5mg

Parts Numbering System

• The part number system shall be in the following format

RF	06	4P	J	R68	CS
Code Designation	Dimension	Resistors	Tolerance	Resistance Value	Packaging Code
RF: Flat type array	06: 0603	2P: 2 Pieces 4P: 4 Pieces	J: ±5% * Jumper: 'J'	3 digit coding system (IEC coding system) E-24 series	CS : Tape Packaging 7" ES : Tape Packaging 10" AS : Tape Packaging 13"

Specification

Type	Power Rating (W)	Working Voltage (MAX)	Overload Voltage (MAX)	TCR (ppm/°C)	Resistance Range (Ω)	Rated Ambient Temperature	Rated Working Temperature
062P 064P	1/32	12.5(V)	25(V)	±250	10 Ω ~1MΩ	70°C	-55°C ~+125°C

• Rated voltage (V) = $\sqrt{\text{Rated power(W)} \times \text{Normal resistance value (R)}}$
 Rated voltage should be lower than (MAX) working voltage.

Power Derating Curve

The rated power is the maximum continuous loading power at 70°C ambient temperature.
 For ambient temperature above 70°C, the loading power follows the below power derating curve.
 (The load current shall be derated according to Derating curve in case of the 'Jumper')

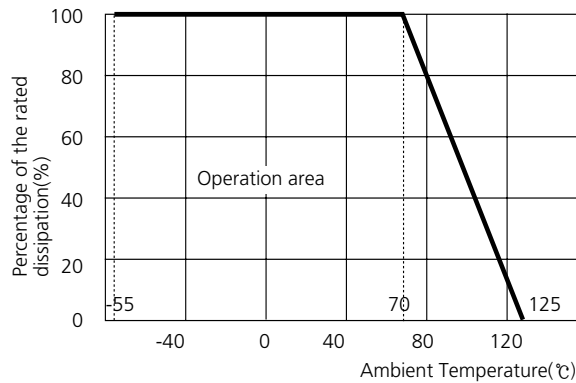

Jumper Resistors

Type	Resistance	Current Rating	Rated Ambient Temperature	Rated Working Temperature
062P 064P	50mΩ Max.	0.5(A)	70°C	-55°C ~+125°C

Land Pattern



TYPE (Inch)	Reflow Soldering				
	A	B	2A + B	C	D
RF062P	0.3	0.3	0.9	0.2	0.3
RF064P	0.3	0.3	0.9	0.2	0.2

Operation Notes

Example of land Pattern Design

Recommended Soldering Conditions

General Structure

General

Precision

Jumper

Low ohms (RC Series)

Low ohms (RUT Series)

Ultra Low Ohms (RU Series)

Ultra Low Ohms (RUW Series)

Ultra Low Ohms (RUK Series)

Arrays (CONVEX Type)

Arrays (CONCAVE Type)

Arrays (FLAT Type)

Arrays for Memory Modules

Attenuator

Characteristics Performance

Packaging

Standard Resistance Value

Arrays for Memory Modules

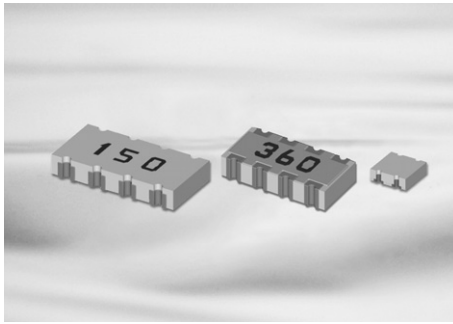

Feature

- Reducing SMD surface area (40% reduced).
- Reducing SMD costs (75% reduced).
- Applicable both flow and reflow soldering.
- Reverse & Short free Reverse Concave Type.

The product of lead-free terminal is RoHS compliant. PhO(lead oxide) is included in the glass of our product which is prescribed on RoHS appendix as an exception.

Application

- For semiconductor devices.
- For computers, digital circuits.

Structure and Dimensions

(1) REVERSE CONCAVE TYPE

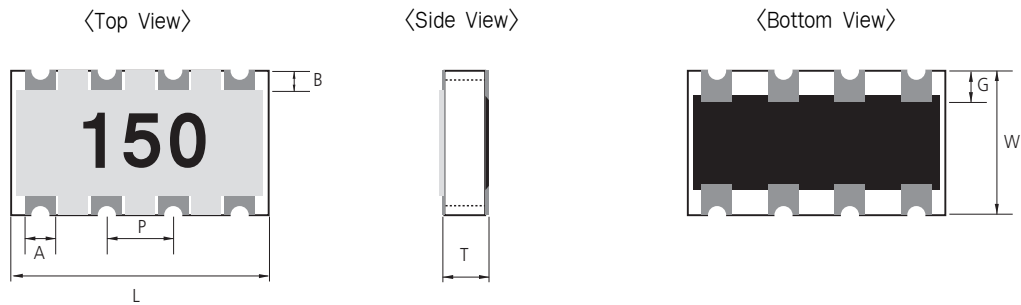

(UNIT: mm)

Type	L	W	T	A	B	G	P	Average Weight
RM102P	1.00±0.10	1.00±0.10	0.35±0.10	0.30±0.10	0.15±0.10	0.25±0.15	0.50±0.10	1.2mg
RM104P	2.00±0.10	1.00±0.10	0.45±0.10	0.30±0.10	0.15±0.10	0.25±0.15	0.50±0.10	2.8mg

(2) SHORT-FREE REVERSE CONCAVE TYPE

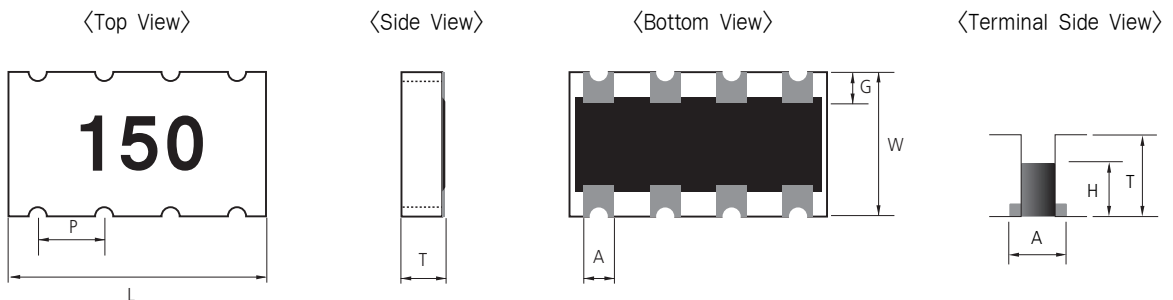

(UNIT: mm)

Type	L	W	T	A	G	P	H	Average Weight
RK102P	1.00±0.10	1.00±0.10	0.35±0.10	0.30±0.10	0.25±0.15	0.50±0.10	0.17min	1.2mg
RK104P	2.00±0.10	1.00±0.10	0.45±0.10	0.30±0.10	0.25±0.15	0.50±0.10	0.23min	2.8mg

Parts Numbering System

- The part number system shall be in the following format

RM	10	4P	J	100	CS
Code Designation	Dimension	Resistors	Tolerance	Resistance Value	Packaging Code
RM : Reverse Concave Array RK : Short-free Reverse Concave Array	10: 1005	2P: 2 Pieces 4P: 4 Pieces	F: ±1% J: ±5% *Jumper:'J'	3 digit coding system (IEC coding system) E-24 series	CS : Tape Packaging 7" ES : Tape Packaging 10" AS : Tape Packaging 13"

Specification

Type	Power Rating (W)	Working Voltage (MAX)	Overload Voltage (MAX)	TCR (ppm/°C)	Resistance Range (Ω)	Rated Ambient Temperature	Rated Working Temperature
102P 104P	1/16	25(V)	50(V)	1~9.9 Ω: ±300 10 Ω~1MΩ: ±200	1 Ω~1MΩ	70°C	-55°C~+125°C

- Rated voltage (V) = $\sqrt{\text{Rated power(W)} \times \text{Normal resistance value (R)}}$
Rated voltage should be lower than (MAX) working voltage.

Power Derating Curve

The rated power is the maximum continuous loading power at 70°C ambient temperature. For ambient temperature above 70°C, the loading power follows the below power derating curve. (The load current shall be derated according to Derating curve in case of the 'Jumper')

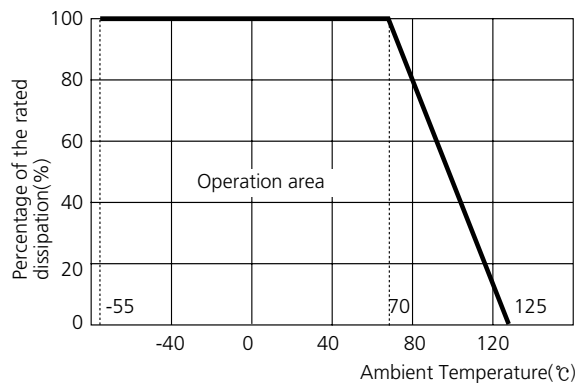

Jumper Resistors

Type	Resistance	Current Rating	Rated Ambient Temperature	Rated Working Temperature
102P 104P	50mΩ Max.	1.0(A)	70°C	-55°C~+125°C

Marking

- 3 digits indication(E-24 series)
 - Left 2 digits represent significant figures.
 - Last 1 digit represents exponential number of 10.
 - Example: 150
 - Left 2 digit: 15
 - Last 1 digit: 0
 - $150 = 15 \times 10^0 = 15 \Omega$

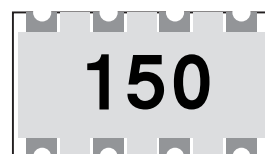

* Jumper chip is printed as "000".

- RM102P, RK102P Type : No marking.

The specifications and designs contained herein may be subject to change without notice. Please contact our sales representatives or product engineers before order.

Operation Notes

Example of land Pattern Design

Recommended Soldering Conditions

General Structure

General

Precision

Jumper

Low ohms (RC Series)

Low ohms (RUT Series)

Ultra Low Ohms (RU Series)

Ultra Low Ohms (RUW Series)

Ultra Low Ohms (RUK Series)

Arrays (CONVEX Type)

Arrays (CONCAVE Type)

Arrays (FLAT Type)

Arrays for Memory Modules

Attenuator

Characteristics Performance

Packaging

Standard Resistance Value

Attenuator

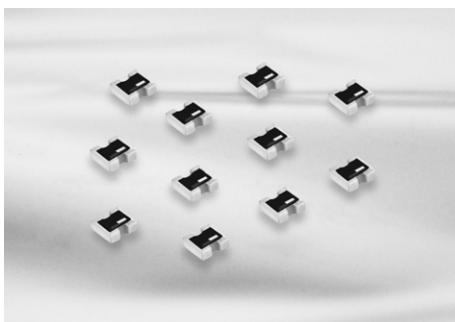

Feature

- The RP10AT is small-size chip Attenuator, suitable for high density surface mounting.
- Unbalanced π type attenuator circuit in one chip(1.0 mm x 1.0 mm)
- Mounting occupation area reduction : about 50 % reduction
- Mounting cost reduction : Mounting times 3 times \rightarrow 1 time
- Attenuation : 0 dB to 10 dB

Application

- Attenuation / level control / impedance matching of high frequency signals of communication equipment; cellular phones(GSM, CDMA, etc.), PHS, PDA, for example.

Structure and Dimensions

• Structure

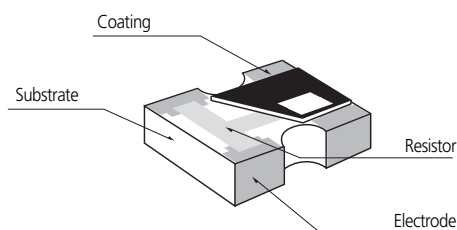

• Dimensions

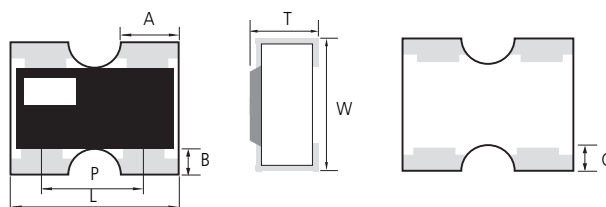

(UNIT: mm)

Type	Power(W)	L	W	T	A	B	C	P	Average Weight
RP10AT	0.04W / package	1.00 \pm 0.10	1.00 \pm 0.10	0.35 \pm 0.10	0.33 \pm 0.05	0.20 \pm 0.10	0.25 \pm 0.10	0.65 \pm 0.10	1.1mg

Parts Numbering System

- The part number system shall be in the following format

RP	10AT	L	A	03	CS
Code Designation	Dimensions & Circuit Configuration	Attenuation Value Tolerance	Characteristic Impedance	Attenuation Value	Packing Type
RP: Convex type	10:1.0x1.0(mm)-0404(inch) AT: Unbalanced π -type Attenuator	L: \pm 0.3 dB H: \pm 0.5 dB	A: 50 ohm	3 dB EX) 0 \rightarrow 0dB	CS: Tape Packaging 7"

Specification

Item	Specifications
Attenuation Value	0 dB~15dB
Attenuation Value Tolerance	0 dB~5 dB : ± 0.3 dB 6 dB~15dB : ± 0.5 dB
Characteristic Impedance	50 Ω
Power Rating	0.04W / package
Frequency Range	DC to 3 GHz
VSWR (Voltage Standing Wave Ratio)	1.3 max
Number of terminals	4 terminals
Category Temperature Range (Operating Temperature Range)	-55 $^{\circ}\text{C}$ to +125 $^{\circ}\text{C}$

Operation Notes

Example of land Pattern Design

Recommended Soldering Conditions

General Structure

General

Precision

Jumper

Low ohms (RC Series)

Low ohms (RUT Series)

Ultra Low Ohms (RU Series)

Ultra Low Ohms (RUW Series)

Ultra Low Ohms (RUK Series)

Arrays (CONVEX Type)

Arrays (CONCAVE Type)

Arrays (FLAT Type)

Arrays for Memory Modules

Attenuator

Characteristics Performance

Packaging

Standard Resistance Value

Power Derating Curve

The rated power is the maximum continuous loading power at 70 $^{\circ}\text{C}$ ambient temperature.
For ambient temperature above 70 $^{\circ}\text{C}$, the loading power follows the below power derating curve.

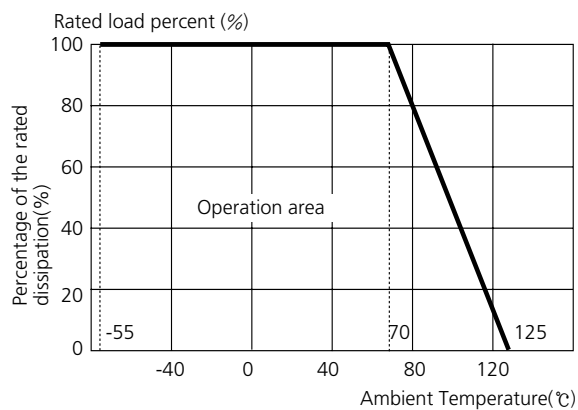

Equivalent Circuit Configuration

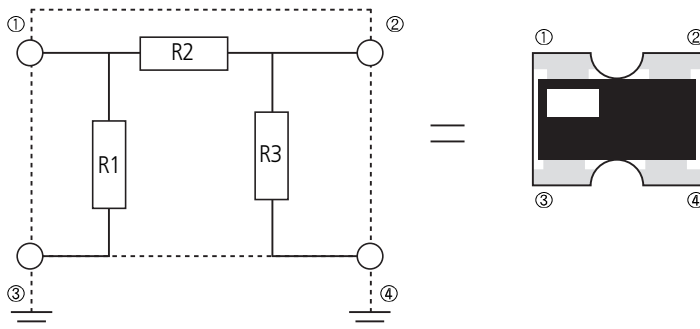

Electrical Characteristic

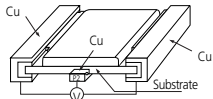
Item	Requirements Specification		Test Methods	
	Resistor	Jumper	Resistor	Jumper
Direct Current Resistance	Within the regulated resistance tolerance.		JIS C 5201-1 4.5 Voltage apply Within 5 sec. Test temp: 20℃, 65RH Test board: <FIG. 1>	
Temperature Characteristic	■J-Grade $1\ \Omega \leq R < 10\ \Omega : +300/-200\text{ppm}/^\circ\text{C}$ $10\ \Omega \leq R \leq 1\text{M}\ \Omega : \pm 100\text{ppm}/^\circ\text{C} (0603 \pm 250\text{ppm})$ $1\text{M}\ \Omega < R \leq 10\text{M}\ \Omega : \pm 300\text{ppm}/^\circ\text{C}$ ■F-Grade $1\ \Omega \leq R \leq 10\text{M}\ \Omega : \pm 100\text{ppm}/^\circ\text{C} (0603 \pm 250\text{ppm})$		JIS C 5201-1 4.8 Test Temperature(℃) 20℃ → -55℃ / 20℃ → 125℃ T.C.R(ppm / ℃)=(R-R ₂₀) / R ₂₀ × 1 / (T-T ₂₀) × 10 ⁶ ※ T=test Temperature, T ₂₀ =20℃ R=Resistance at T, R ₂₀ =Resistance at T ₂₀ Test board: <FIG. 1>	
Short-time Overload	ΔR	Less than ±(1%+0.1 Ω) of the initial value.	50m Ω Max.	JIS C 5201-1 4.13 Apply 2.5 times rated voltage for 5 sec. Wait 60 minutes at room temperature. Measure the resistance value. Test board: <FIG. 1>
	Visual	No evidence of mechanical damage.		
Intermittent Overload	ΔR	Less than ±(3%+0.1 Ω) of the initial value.	50m Ω Max.	JIS C 5201-1 4.13 2.5 times of rated voltage . 1 second ON, 25 second OFF. 10,000 cycles. Test board: <FIG. 1>
	Visual	No evidence of mechanical damage.		
Dielectric Withstanding Voltage	No evidence of mechanical damage.		JIS C 5201-1 4.7 Apply Voltage for 1 minute 0402.0603:50V 1005, 1608: 100V Other: 500V	
Insulation Resistance	Over 1,000M Ω			

Mechanical Characteristic

Item	Requirements Specification		Test Methods	
	Resistor	Jumper	Resistor	Jumper
Solderability	Coverage: ≥95% each termination. No crack of termination parts and ceramic exposure of surface by melting.		IEC60068-2-58 Rosin Flux: Rosin 25%, Methanol 75% Solder Temp.: 245±5/-0℃ Dipping time: 2±0.5 sec.(Both side dipping)	
Bending Test	ΔR	Less than ±(1.0%+0.05Ω) of the initial value.	50m Ω Max.	JIS C 5201-1 4.33 After soldering resistor on the PCB, 3mm of bending shall be applied for 10 sec. Test board: <FIG. 2>
	Visual	No evidence of mechanical damage.		
Adhesive strength of termination	·No mechanical damage or sign of disconnection		JIS C 5201-1(4.16) - Test strength : 5N (500g · f), 0603 : 2N - Test time : Applying pressure for 10 seconds 	
Resistance to Soldering Heat	ΔR	Less than ±(1%+0.05 Ω) of the initial value.	50m Ω Max.	JIS C 5201-1 4.18 - Flow soldering : 260±5℃, 10 sec. max.(both side dipping) - Reflow soldering : 260±5℃, 10 sec. max. over 230℃, 30~40 sec.
	Visual	No evidence of mechanical damage.		
Anti-Vibration Test	ΔR	Less than ±(1%+0.05 Ω) of the initial value.	50m Ω Max.	JIS C 5201-1 4.22 2 hours each in X, Y and Z axis(total 6 hours) 10 to 55Hz sweep in 1 minute at 1.5mm amplitude.
	Visual	No evidence of mechanical damage.		

Environmental Characteristic

Item	Requirements Specification		Test Methods	
	Resistor	Jumper	Resistor	Jumper
Temperature Cycle	ΔR	Less than $\pm(1\%+0.1 \Omega)$ of the initial value.	50mΩ Max.	JIS C 5201-1 4.19 Perform 100 cycles as follows. Test Condition: -55 °C/30min ↔ 125 °C/30min sweep time: 5 min Test board: <FIG. 1>
	Visual	No evidence of mechanical damage.		
Load Life	ΔR	Less than $\pm(3\%+0.1 \Omega)$ of the initial value.	50mΩ Max.	JIS C 5201-1 4.25 Test Voltage: rated voltage Test temp.: 70±2 °C Time: 1,000 ⁺⁴⁸ hours(90 min; ON, 30 min; OFF) Test board: <FIG. 1>
	Visual	No evidence of mechanical damage.		
Low Temp. Exposure	ΔR	Less than $\pm(3\%+0.1 \Omega)$ of the initial value.	50mΩ Max.	JIS C 5201-1 4.23 Dwell in -55 °C chamber without loading for 1,000 ⁺⁴⁸ hours. Stabilize for 60 minutes at room temperature. Measure value. Test board: <FIG. 1>
	Visual	No evidence of mechanical damage.		
High Temp. Exposure	ΔR	Less than $\pm(3\%+0.1 \Omega)$ of the initial value.	50mΩ Max.	JIS C 5201-1 4.23 Dwell in 125 °C±2 °C or 155 °C±2 °C chamber without loading for 1,000 ⁺⁴⁸ hours. Stabilize for 60 minutes at room temperature. Measure value. Test board: <FIG. 1>
	Visual	No evidence of mechanical damage.		
Moisture Resistance	ΔR	Less than $\pm(3\%+0.1 \Omega)$ of the initial value.	50mΩ Max.	JIS C 5201-1 4.14 Test Voltage: rated voltage Test temp.: 40±2 °C Time: 1,000 ⁺⁴⁸ hours(90 min; ON, 30 min; OFF) Humidity: 90~95% RH Stabilize for 1 hrs & Measure. Test board: <FIG. 1>
	Visual	No evidence of mechanical damage.		

* These characteristics apply to 1 Ω ~ 10M Ω. In case of other resistance range, please contact us.

* The next is specification in our company for flow soldering and test boards.

Flow soldering Conditions

Item	Specification	Dipping
Flux	ROSIN 25%, IPA 75%	Time: 5~10 sec.
Solder	Sn-3.0Ag-0.5Cu	Time: 10 sec max. Temp.: 260±5 °C.

Operation Notes

Example of land Pattern Design

Recommended Soldering Conditions

General Structure

General

Precision

Jumper

Low ohms (RC Series)

Low ohms (RUT Series)

Ultra Low Ohms (RU Series)

Ultra Low Ohms (RUW Series)

Ultra Low Ohms (RUK Series)

Arrays (CONVEX Type)

Arrays (CONCAVE Type)

Arrays (FLAT Type)

Arrays for Memory Modules

Attenuator

Characteristics Performance

Packaging

Standard Resistance Value

Taping Type

• Reel dimensions

Unit: mm

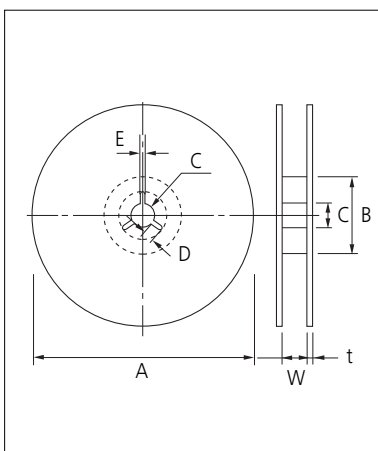

Symbol	Tape Width	A	B	C	D
7" Reel	8mm	$\varnothing 180+0/-3$	$\varnothing 60\pm 1.0$	$\varnothing 13\pm 0.3$	4 ± 0.2
	12mm	$\varnothing 180+0/-3$	$\varnothing 60\pm 1.0$	$\varnothing 13\pm 0.3$	4 ± 0.2
10" Reel	8mm	$\varnothing 258+0/-3$	$\varnothing 80\pm 1.0$	$\varnothing 13\pm 0.3$	4 ± 0.2
	12mm	$\varnothing 258+0/-3$	$\varnothing 80\pm 1.0$	$\varnothing 13\pm 0.3$	4 ± 0.2
13" Reel	8mm	$\varnothing 330\pm 2.0$	$\varnothing 100\pm 1.0$	$\varnothing 13\pm 0.3$	4 ± 0.2
	12mm	$\varnothing 330\pm 2.0$	$\varnothing 80\pm 1.0$	$\varnothing 13\pm 0.3$	4 ± 0.2

Symbol	Tape Width	E	W	t
7" Reel	8mm	2.0 ± 0.5	9 ± 0.5	1.2 ± 0.2
	12mm	2.0 ± 0.5	13 ± 0.5	1.2 ± 0.2
10" Reel	8mm	2.0 ± 0.5	9 ± 0.5	1.8 ± 0.2
	12mm	2.0 ± 0.5	13 ± 0.5	1.8 ± 0.2
13" Reel	8mm	2.0 ± 0.5	9 ± 0.5	2.2 ± 0.2
	12mm	2.0 ± 0.5	13 ± 0.5	2.2 ± 0.2

• Tape dimensions

(UNIT: mm)

Type	Pitch	Width	Dimensions																																												
Press Pocket or Punched Paper	2mm	8mm																																													
			<table border="1"> <thead> <tr> <th></th> <th>A</th> <th>B</th> <th>T</th> </tr> </thead> <tbody> <tr> <td>0402</td> <td>0.24 ± 0.03</td> <td>0.45 ± 0.03</td> <td>0.5 Max</td> </tr> <tr> <td>0603</td> <td>0.38 ± 0.05</td> <td>0.68 ± 0.05</td> <td>0.5 Max</td> </tr> <tr> <td>1005</td> <td>0.70 ± 0.10</td> <td>1.20 ± 0.10</td> <td>0.6 Max</td> </tr> <tr> <td>RF062P</td> <td>0.70 ± 0.10</td> <td>0.90 ± 0.10</td> <td>0.35 Max</td> </tr> <tr> <td>RF064P</td> <td>0.70 ± 0.10</td> <td>1.60 ± 0.10</td> <td>0.35 Max</td> </tr> <tr> <td>RP102</td> <td>1.17 ± 0.10</td> <td>1.17 ± 0.10</td> <td>0.6 Max</td> </tr> <tr> <td>RP10AT</td> <td>1.20 ± 0.10</td> <td>1.20 ± 0.10</td> <td>0.6 Max</td> </tr> <tr> <td>RN102</td> <td>1.20 ± 0.10</td> <td>1.20 ± 0.10</td> <td>0.6 Max</td> </tr> <tr> <td>RP104</td> <td>1.20 ± 0.10</td> <td>2.20 ± 0.10</td> <td>0.6 Max</td> </tr> <tr> <td>RN104</td> <td>1.20 ± 0.10</td> <td>2.20 ± 0.10</td> <td>0.8 Max</td> </tr> </tbody> </table> <p>-0603: Press pocket.</p>		A	B	T	0402	0.24 ± 0.03	0.45 ± 0.03	0.5 Max	0603	0.38 ± 0.05	0.68 ± 0.05	0.5 Max	1005	0.70 ± 0.10	1.20 ± 0.10	0.6 Max	RF062P	0.70 ± 0.10	0.90 ± 0.10	0.35 Max	RF064P	0.70 ± 0.10	1.60 ± 0.10	0.35 Max	RP102	1.17 ± 0.10	1.17 ± 0.10	0.6 Max	RP10AT	1.20 ± 0.10	1.20 ± 0.10	0.6 Max	RN102	1.20 ± 0.10	1.20 ± 0.10	0.6 Max	RP104	1.20 ± 0.10	2.20 ± 0.10	0.6 Max	RN104	1.20 ± 0.10	2.20 ± 0.10	0.8 Max
				A	B	T																																									
			0402	0.24 ± 0.03	0.45 ± 0.03	0.5 Max																																									
			0603	0.38 ± 0.05	0.68 ± 0.05	0.5 Max																																									
			1005	0.70 ± 0.10	1.20 ± 0.10	0.6 Max																																									
			RF062P	0.70 ± 0.10	0.90 ± 0.10	0.35 Max																																									
			RF064P	0.70 ± 0.10	1.60 ± 0.10	0.35 Max																																									
			RP102	1.17 ± 0.10	1.17 ± 0.10	0.6 Max																																									
			RP10AT	1.20 ± 0.10	1.20 ± 0.10	0.6 Max																																									
RN102	1.20 ± 0.10	1.20 ± 0.10	0.6 Max																																												
RP104	1.20 ± 0.10	2.20 ± 0.10	0.6 Max																																												
RN104	1.20 ± 0.10	2.20 ± 0.10	0.8 Max																																												
Punched Paper	4mm	8mm																																													
			<table border="1"> <thead> <tr> <th></th> <th>A</th> <th>B</th> <th>T</th> </tr> </thead> <tbody> <tr> <td>1608</td> <td>1.10 ± 0.20</td> <td>1.90 ± 0.20</td> <td>0.8 Max</td> </tr> <tr> <td>2012</td> <td>1.65 ± 0.20</td> <td>2.40 ± 0.20</td> <td rowspan="4">1.1 Max</td> </tr> <tr> <td>3216</td> <td>2.00 ± 0.20</td> <td>3.60 ± 0.20</td> </tr> <tr> <td>3225</td> <td>2.90 ± 0.20</td> <td>3.60 ± 0.20</td> </tr> <tr> <td>RP164</td> <td>2.00 ± 0.20</td> <td>3.60 ± 0.20</td> </tr> </tbody> </table>		A	B	T	1608	1.10 ± 0.20	1.90 ± 0.20	0.8 Max	2012	1.65 ± 0.20	2.40 ± 0.20	1.1 Max	3216	2.00 ± 0.20	3.60 ± 0.20	3225	2.90 ± 0.20	3.60 ± 0.20	RP164	2.00 ± 0.20	3.60 ± 0.20																							
				A	B	T																																									
			1608	1.10 ± 0.20	1.90 ± 0.20	0.8 Max																																									
			2012	1.65 ± 0.20	2.40 ± 0.20	1.1 Max																																									
3216	2.00 ± 0.20	3.60 ± 0.20																																													
3225	2.90 ± 0.20	3.60 ± 0.20																																													
RP164	2.00 ± 0.20	3.60 ± 0.20																																													
Embossed Tape	12mm	8mm																																													
			<table border="1"> <thead> <tr> <th></th> <th>A</th> <th>B</th> <th>T</th> </tr> </thead> <tbody> <tr> <td>5025</td> <td>2.80 ± 0.20</td> <td>5.30 ± 0.20</td> <td rowspan="2">1.1 Max</td> </tr> <tr> <td>6432</td> <td>3.50 ± 0.20</td> <td>6.75 ± 0.20</td> </tr> </tbody> </table>		A	B	T	5025	2.80 ± 0.20	5.30 ± 0.20	1.1 Max	6432	3.50 ± 0.20	6.75 ± 0.20																																	
	A	B	T																																												
5025	2.80 ± 0.20	5.30 ± 0.20	1.1 Max																																												
6432	3.50 ± 0.20	6.75 ± 0.20																																													

Packaging Table

TYPE (mm)	TYPE (inch)	Taping Packaging					
		Code	Reels	Carrier Tape	Quantity	Weight(g)	
0402	01005	CS	7"	Pressed Paper	20,000	143	
0603	0201	CS	7"	Pressed Paper	15,000	126	
		DP	7"	Punched PE	20,000	154	
		AS	13"	Pressed Paper	60,000	573	
		FP	13"	Punched PE	50,000	474	
1005	0402	CS	7"	Punched paper	10,000	92	
		DS	7"		20,000	152	
		ES	10"		30,000	331	
		AS	13"		40,000	539	
1608	0603	CS	7"		5,000	125	
		ES	10"		10,000	324	
		AS	13"		20,000	561	
2012	0805	CS	7"		5,000	149	
		ES	10"		10,000	360	
		AS	13"		20,000	658	
3216	1206	CS	7"		5,000	157	
		ES	10"		10,000	382	
		AS	13"		20,000	695	
3225	1210	CS	7"		5,000	183	
		ES	10"		10,000	463	
		AS	13"		20,000	674	
5025	2010	CS	7"	Embossed PE	4,000	202	
6432	2512	CS	7"		4,000	267	
		AS	13"	15,000	1,041		
062P	0201×2R	CS	7"	Punched paper	20,000	126	
064P	0201×4R	CS	7"		20,000	126	
102P	0402×2R	CS	7"		10,000	100	
		AS	13"		40,000	485	
104P	0402×4R	CS	7"		10,000	136	
		AS	13"		40,000	610	
164P	0603×4R	CS	7"		5,000	157	
		AS	13"		20,000	695	
		AS	13"		20,000	695	
10AT (1010)	0404	CS	7"		Punched paper	10,000	100
		AS	13"			40,000	485

- General type, Precision, Low ohms, High ohms.
- Packaging style can be modified when you want.

Operation Notes

Example of land Pattern Design

Recommended Soldering Conditions

General Structure

General

Precision

Jumper

Low ohms (RC Series)

Low ohms (RUT Series)

Ultra Low Ohms (RU Series)

Ultra Low Ohms (RUW Series)

Ultra Low Ohms (RUK Series)

Arrays (CONVEX Type)

Arrays (CONCAVE Type)

Arrays (FLAT Type)

Arrays for Memory Modules

Attenuator

Characteristics Performance

Packaging

Standard Resistance Value

Standard Resistance Value

Tolerance Code Table

Tolerance Code	D	F	G	J	K	M
Digit Number	4 digit			3 digit		
IEC-Code System	E-192	E-96	E-48	E-24	E-12	E-6
Specification	±0.5%	±1%	±2%	±5%	±10%	±20%

Significant Figure of Resistance Value

E-192	E-96	E-48	E-24	E-192	E-96	E-48	E-24	E-192	E-96	E-48	E-24	E-192	E-96	E-48	E-24
100	100	100	10	178	178	178		316	316	316		562	562	562	56
101				180			18	320				569			
102	102			182	182			324	324			576	576		
104				184				328				583			
105	105	105		187	187	187		332	332	332	33	590	590	590	
106				189				336				597			
107	107			191	191			340	340			604	604		
109				193				344				612			
110	110	110	11	196	196	196		348	348	348		619	619	619	
111				198				352				626			62
113	113			200	200		20	357	357			634	634		
114				203				361				642			
115	115	115		205	205	205		365	365	365	36	649	649	649	
117				208				370				657			
118	118			210	210			374	374			665	665		
120			12	213				379				673			
121	121	121		215	215	215		383	383	383		681	681	681	68
123				218				388				690			
124	124			221	221		22	392	392		39	698	698		
126				223				397				706			
127	127	127		226	226	226		402	402	402		715	715	715	
129				229				407				723			
130	130		13	232	232			412	412			732	732		
132				234				417				741			
133	133	133		237	237	237		422	422	422		750	750	750	75
135				240			24	427				759			
137	137			243	243			432	432		43	768	768		
138				246				437				777			
140	140	140		249	249	249		442	442	442		787	787	787	
142				252				448				796			
143	143			255	255			453	453			806	806		
145				258				459				816			
147	147	147		261	261	261		464	464	464		825	825	825	82
149				264				470			47	835			
150	150		15	267	267			475	475			845	845		
152				271			27	481				856			
154	154	154		274	274	274		487	487	487		866	866	866	
156				277				493				876			
158	158			280	280			499	499			887	887		
160			16	284				505				898			
162	162	162		287	287	287		511	511	511	51	909	909	909	
164				291				517				920			91
165	165			294	294			523	523			931	931		
167				298				530				942			
169	169	169		301	301	301	30	536	536	536		953	953	953	
172				305				542				965			
174	174			309	309			549	549			976	976		
176				312				556				988			

• Example

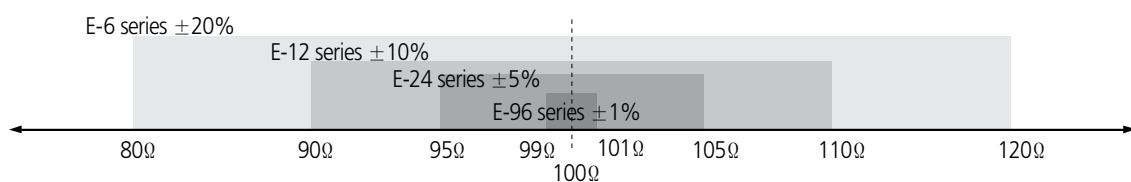

ISO/TS 16949



ISO 14001



OHSAS 18001



QC080000



Operation Notes

Example of land Pattern Design

Recommended Soldering Conditions

General Structure

General

Precision

Jumper

Low ohms (RC Series)

Low ohms (RUT Series)

Ultra Low Ohms (RU Series)

Ultra Low Ohms (RUW Series)

Ultra Low Ohms (RUK Series)

Arrays (CONVEX Type)

Arrays (CONCAVE Type)

Arrays (FLAT Type)

Arrays for Memory Modules

Attenuator

Characteristics Performance

Packaging

Standard Resistance Value

Quality System Certification List

Table 1: Certification list of Samsung Factory

Certification	Section	High Tech(China)
ISO / TS 16949	Authority	BSI
	Number	TS 91430-008
	Date	2011 - 11 - 29
	Validity	2014 - 11 - 28
ISO 14001	Authority	BSI
	Number	EMS 585307
	Date	2012 - 04 - 17
	Validity	2015 - 04 - 16
OHSAS 18001	Authority	BSI
	Number	OHS 585308
	Date	2012 - 04 - 17
	Validity	2015 - 04 - 16
QC080000	Authority	UL
	Number	PRC-HSPM-1766
	Date	2010 - 07 - 27
	Validity	2013 - 07 - 26



Passive components sales offices

• Head office

206, Cheomdansaneop Road,
Yeongtong-gu, Suwon-city,
Gyeonggi province, Korea,
443-743

Europe

Tel: +82-31-210-6328

E-mail: james.pyun@samsung.com

America

Tel: +82-31-210-6803

E-mail: wesley.roh@samsung.com

Asia

Tel: +82-31-210-6791

E-mail: peter_kim@samsung.com

Domestic

Tel: +82-31-210-5074

E-mail: bounggho.lee@samsung.com

• Manufacturing sites

Suwon Plant (Korea)

206, Cheomdansaneop Road,
Yeongtong-gu, Suwon-city,
Gyeonggi province, Korea,
443-743

Tel: +82-31-210-5074

E-mail: bounggho.lee@samsung.com

Busan Plant (Korea)

1623-2, Songjeong-dong,
Gangseo-gu, Busan, Korea,
618-270

Tel: +82-51-970-7671

E-mail: kyc.kweon@samsung.com

Tianjin Plant (China)

27, Heiniucheng-Road, Hexi District,
Tianjin, 300210 China

Tel: +86-22-2397-9000(310)

E-mail: moohantop.Park@samsung.com

High Tech (China)

Xiqing Dist. Micro-Electronics
Industrial Park, Jingang Highway,
Tianjin, China 300485

Tel: + 022-23979000-313

E-mail: enhao.song@samsung.com

Bin Hai Plant (China)

80, Xiaqing Road, West area of
Bin Hai development zone,
Tianjin, 300458, China

Tel: +86-22-6686-3333(1300)

E-mail: sk1000.kim@samsung.com

Philippines Plant (Philippines)

Block No.5, Calamba Premiere
International Park, Batino, Calamba,
Laguna, Manila, Philippines 4027

Tel: +63-49-545-0422

E-mail: donna@samsung.com

• Asia sales offices

Shenzhen Office

46 F, New World Center,
Yitian Road, Futian District,
Shenzhen, 518026 China

Tel: +86-755-8608-5571

E-mail: jackson.xian@samsung.com

Shanghai Office

Rm. 1211, Shanghai International
Trade Center, No. 2201 Yan an(W) Rd.,
Shanghai, 200335 China

Tel: +86-21-6270-4168(274)

E-mail: dennis.cha@samsung.com

HongKong Office

8/F., Central Plaza, 18 Harbour Road,
Wanchai, Hongkong, China

Tel: +852-28626344

E-mail: vivianchan@samsung.com

Qingdao Office

Rm 1201. Growne Plaza Qingdao 76,
Xiang Gang Zhong Rd, Qingdao,
266071 China

Tel: +86-532-85779102

E-mail: zhengguo.cui@samsung.com

Taiwan Office

9F-1, Np. 399 Ruey Kuang Rd., Neihu
District, Taipei City, Taiwan, 114

Tel: +886-2-2656-8356

E-mail: kevin0130.wang@samsung.com

Singapore Office

3 Church Street Samsung Hub,
#23-02 Singapore 049483

Tel: +65-6833-3228

E-mail: winson.yeong@samsung.com

Bangkok Office

23rd Floor, Lake Rajada Office Complex
193/89 Rachadapisek Road,
Khet Klongtoey, Bangkok 10110, Thailand

Tel: +66-2-661-8004~5

E-mail: yangshin.yi@samsung.com

• America sales office

Irvine Office

3333 Michelson Drive,
Suite 500, Irvine, CA 92612, USA

Tel: +1-949-797-8016

E-mail: andrew.skelly@samsung.com

• Europe sales offices

Frankfurt Office

Samsung Haus, Am Kronberger Hang 6,
D-65824 Schwalbach/Ts. Germany

Tel: +49-6196-66-7255

E-mail: frank.goebel@samsung.com

Hungary Office

H-2310, Leshegy utca 2-4,
Szigetszentmiklos, Pest megye, Hungary

Tel: +36-24-551-148

E-mail: jun21c.lee@samsung.com

• Domestic Distributors

Korchip Corporation

817-38, Anyang 2-dong, Manan-gu,
Anyang-city, Gyeonggi province,
Korea, 430-812

Tel: +82-31-361-8100

E-mail: itasap@korchip.com

SAMT

Daekyung Bldg., 983-10, Daechi-dong,
Gangnam-gu, Seoul, Korea

Tel: +82-2-3458-9000

E-mail: info@isamt.com

CHUNGMAC

301 Gwonseon Medivill, 544-14
Gokbanjeong-dong, Gwonseon-gu,
Suwon-si, Gyeonggi-do Korea

Tel: +82-31-234-2367~8

E-mail: webmaster@chungmac.co.kr

YOUNGDUK

Gasan-Dong 632, Seobusaetgil,
Geumcheon-Gu, Seoul, Korea

Tel: +82-2-2107-7860

E-mail: siyang1109@gmail.com

All information indicated in this catalog is as of July 2012

* The specifications and designs contained herein may be subject to change without notice.