

Data Sheet | Item Number: 224-101

Lighting connector; push-button on lighting side; Lighting side: for all conductor types; Inst. side: for solid conductors; 224 Series; max. 2.5 mm²; Surrounding air temperature: max 60°C; 2,50 mm²; gray

<https://www.wago.com/224-101>



Color: ■ gray

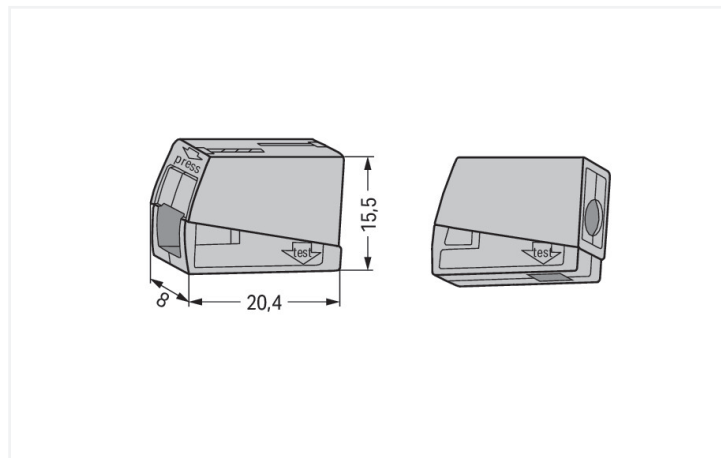

Dimensions in mm

Lighting connector, 224 Series, PUSH WIRE®

Our lighting connector (item number 224-101) ensures effortless electrical installations. WAGO's 224 Series lighting connectors simplify the connection of fine-stranded and solid conductors. Connecting lights is a straightforward task—for quick, easy, and reliable connections. Wherever you need this type of connection, e.g., in office buildings, homes, or other locations, our 224 Series is sure to impress. Conductors can only be connected to this lighting connector if their strip length is between 9 and 11 mm. Our splicing connector is rated for 400 V and is designed to handle a rated current of up to 24 A. It can therefore be used in high-load applications. This product features conductor terminals and utilizes PUSH WIRE® as well as CAGE CLAMP®. Our PUSH WIRE® connection offers a quick and easy solution for connecting solid conductors. Our reliable and maintenance-free CAGE CLAMP® connection makes it easy to connect all types of conductors without having to prepare the conductor. For example, you don't need to crimp ferrules. The item's dimensions are (8 x 15.5 x 20.4) mm (width x height x depth). Depending on the type of conductor, this lighting connector is ideal for conductor cross sections ranging from 1 mm² to 2.5 mm² on one side and for conductor cross sections from 0.5 mm² to 2.5 mm² on the other side.

Notes

Safety Information

in grounded power lines

Electrical data

Ratings per	EN 60664		
Overvoltage category	III	III	II
Pollution degree	3	2	2
Nominal voltage	-	-	400 V
Rated impulse withstand voltage	-	-	4 kV
Rated current	-	-	24 A

General information

Wiring direction Side-entry wiring

Connection Data

Clamping units	2
Total number of potentials	1

Connection 1

Connection type	Installation side
Connection technology	PUSH WIRE®
Number of connection points	1
Actuation type	Push-in
Connectable conductor materials	Copper Aluminum

Connectable conductor materials (note) **Terminating Aluminum Conductors (not for use in North America)** WAGO Spring-Clamp Terminal Blocks are also suitable for solid aluminum conductors up to 4 mm²/12 AWG if WAGO "Alu-Plus" Contact Paste [249-130](#) is used for termination.

"Alu-Plus" Contact Paste Advantages:

- Automatically destroys the oxide film during clamping.
- Prevents fresh oxidation at the clamping point.
- Prevents electrolytic corrosion between aluminum and copper conductors (in the same terminal block).
- Provides long-term protection against corrosion.

Using terminal blocks with CAGE CLAMP® Spring Pressure Connection Technology, **aluminum conductors must first be cleaned with a blade** and then immediately inserted into the clamping units filled with "Alu-Plus" contact paste.

For spring clamp connections with PUSH WIRE® connection technology, **WAGO recommends that the aluminum conductor first be cleaned** and then immediately inserted into the clamping unit filled with "Alu-Plus" contact paste.

It is also possible to apply WAGO "Alu-Plus" **additionally** on the whole surface of the aluminum conductor before termination.

Please note that the nominal currents must be adapted to the reduced conductivity of the aluminum conductors:
 2.5 mm² = 16 A
 4 mm² = 22 A

Solid conductor	1 ... 2.5 mm ² / 14 ... 12 AWG
Strip length	9 ... 11 mm / 0.35 ... 0.43 inches
Wiring direction	Side-entry wiring

Connection 2

Connection type	Lighting side
Connection technology	CAGE CLAMP®
Number of connection points	1
Solid conductor	0.5 ... 2.5 mm ² / 20 ... 16 AWG
Fine-stranded conductor	0.5 ... 2.5 mm ² / 20 ... 16 AWG

Physical data

Width	8 mm / 0.315 inches
Height	15.5 mm / 0.61 inches
Depth	20.4 mm / 0.803 inches

Material data

Note (material data)	Information on material specifications can be found here
Color	gray
Fire load	0.035 MJ
Weight	1.8 g

Environmental requirements

Ambient temperature (operation)	+60 °C
Continuous operating temperature	105 °C

Commercial data

PU (SPU)	1000 (100) pcs
Packaging type	Box
Country of origin	CH
GTIN	4044918583817
Customs tariff number	85369010000

Product Classification

UNSPSC	39121409
eCl@ss 10.0	27-14-11-03
eCl@ss 9.0	27-14-11-03
ETIM 9.0	EC000446
ETIM 10.0	EC000446
ECCN	NO US CLASSIFICATION

Environmental Product Compliance

RoHS Compliance Status	Compliant, No Exemption
------------------------	-------------------------

Approvals / Certificates

General approvals



Approval	Standard	Certificate Name
CSA DEKRA Certification B.V.	C22.2	1053495
UL UL International Germany GmbH	EN 60998	CCA-2617-A1
UL UL International Germany GmbH	EN 60998	D-05895-A1 (EN60998-1 EN60998-2-2)
UL UL International Germany GmbH	UL 486C	E69654
VDE VDE Prüf- und Zertifizierungsinstitut	EN 60998	40022792

Declarations of conformity and manufacturer's declarations

Approval	Standard	Certificate Name
EU-Declaration of Conformity WAGO GmbH & Co. KG	-	-
UK-Declaration of Conformity WAGO GmbH & Co. KG	-	-

Approvals for marine applications



Approval	Standard	Certificate Name
ABS American Bureau of Ship- ping	-	23-2417173-PDA
LR Lloyds Register	EN 60998	LR22207029TA
PRS Polski Rejestr Statków	EN 60998	TE/1093/880590/23

Downloads

Environmental Product Compliance

Compliance Search
Environmental Product Compliance 224-101 ↓

Documentation

Bid Text			
224-101	19.02.2019	xml 3.44 KB	↓
224-101	21.02.2019	docx 15.52 KB	↓

CAD/CAE-Data

CAD data
2D/3D Models 224-101 ↓

CAE data
EPLAN Data Portal 224-101 ↓
WSCAD Universe 224-101 ↓
ZUKEN Portal 224-101 ↓

1 Compatible Products

1.1 Optional Accessories

1.1.1 Tool

1.1.1.1 "Alu-Plus" contact paste



Item No.: 249-130

Syringe; Contents: 20 ml Alu contact paste

Installation Notes

Conductor termination

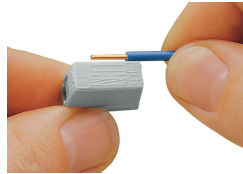
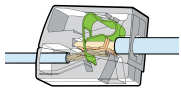

Lighting Connectors (2.5 mm²), 224 Series

Strip conductor to 9 ... 11 mm (0.35 ... 0.43 inch).

Conductor termination

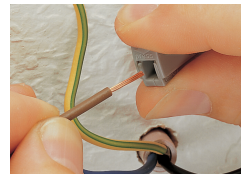
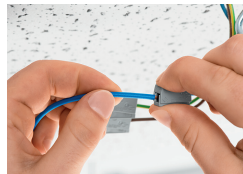

To connect: Press button fully, insert stripped conductor into square entry and release.

To remove: Press button and withdraw conductor.

Conductor termination

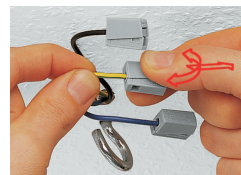
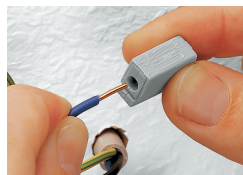

To connect: Insert stripped solid conductor into circular entry and push until it hits the backstop.

To remove: Hold conductor to be removed and twist alternately left and right while slightly pulling the connector.

Testing



Testing via separate test ports.

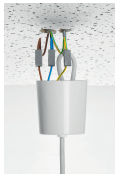

Connecting solid conductors with fine-stranded conductors via lighting connectors (224-101).