

# Rotary Encoder

## Model EN11 Series

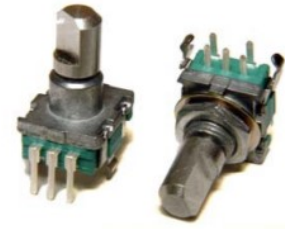

### Features:

- 11 mm rotary encoder
- 2 bits gray code
- Incremental/Contacting type
- Metal bushing/shaft
- Push-on switch option

### Model Styles Available

Top adjust, with switch, threaded bushing	EN11-HSM
Top adjust, without switch, threaded bushing	EN11-HNM
Top adjust, with switch, plain bushing	EN11-HSB
Top adjust, without switch, plain bushing	EN11-HNB
Side adjust, with switch, threaded bushing	EN11-VSM
Side adjust, without switch, threaded bushing	EN11-VNM
Side adjust, with switch, plain bushing	EN11-VSB
Side adjust, without switch, plain bushing	EN11-VNB

### Electrical

Pulses (per revolution)	15, 20
Encoder closed circuit resistance	3 Ohms, max.
Encoder contact rating	10mA/5Vdc
Operating current, maximum	10mA
Dielectric strength	300Vac/1mA, 1 minute
Insulation resistance, minimum	100M ohms at 250Vdc/ 1 mA
Sliding Noise (at 60 RPM)	2.0ms max.
Contact Bounce (at 15 RPM)	5.0ms max.
Operating speed (RPM)	100 RPM max.
Switch power rating	10mA/5Vdc
Switch contact resistance	100 miliohms
Actual electrical travel, nominal	Continuous

#### Notes:

1. Specifications subject to change without notice

#### General Note

TT Electronics reserves the right to make changes in product specification without notice or liability. All information is subject to TT Electronics' own data and is considered accurate at time of going to print.

### Mechanical

Total mechanical travel	Continuous
Detents (per revolution)	0, 20 and 30
Rotational torque of detent, maximum	2.5 oz-in
Switch operating force	550 gf
Switch travel	0.5mm

### Environmental

Operating temperature range	-10°C to +70°C
Rotational life	30,000 cycles

### Ordering Information

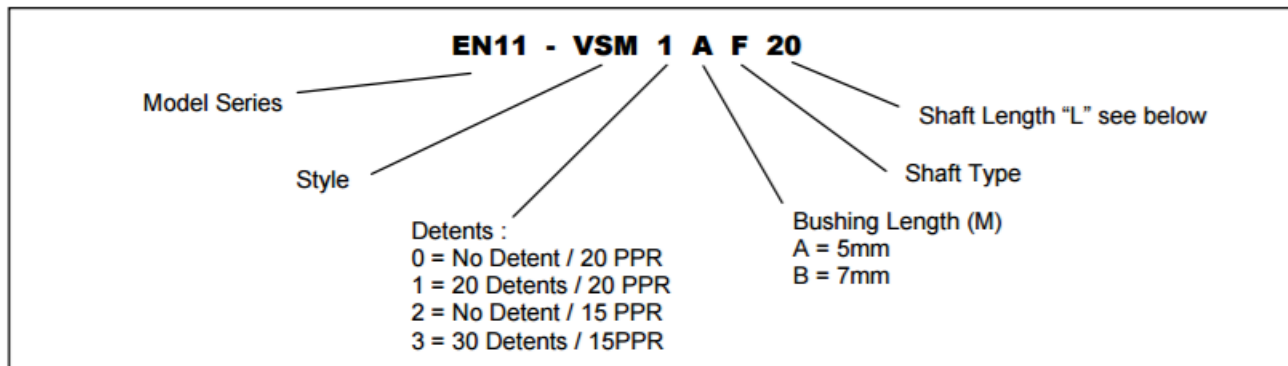

**Notes:**

1. Contact our customer service for custom designs and features.

### Shaft Types–N types (No switch)

#### Q Type

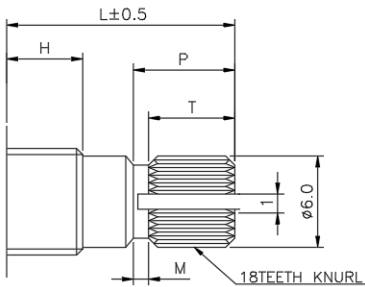

#### H = 5mm

L	12.5	15	20	25	30
P	7	7	7	11	14
T	6	6	6	10	12
M	1	1	1	2	4

#### H = 7mm

L	15	20	25	30
P	7	7	11	14
T	6	6	10	12
M	1	1	2	4

#### F Type

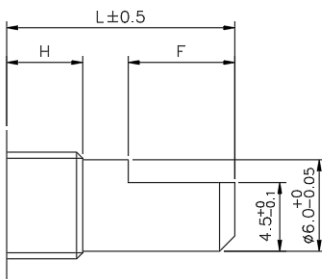

#### H = 5mm

L	12	15	20	25	30
F	5	7	12	12	12

#### H = 7mm

L	15	20	25	30
F	7	7	12	12

### Shaft Types–S types (Switch)

#### Q Type

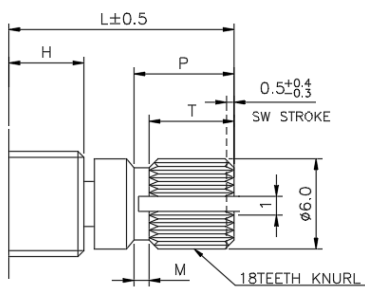

#### H = 5mm

L	12	15	20	25	30
P	4.5	7	7	11	14
T	4.5	6	6	10	12
M	1	2	2	2	4

#### H = 7mm

L	15	20	25	30
P	6	7	11	14
T	5	6	10	12
M	1	1	2	4

#### F Type

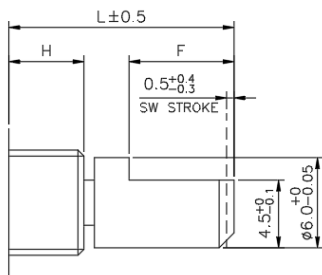

#### H = 5mm

L	12	15	20	25	30
F	5	7	12	12	12

#### H = 7mm

L	15	20	25	30
F	7	10	12	12

General Note  
 TT Electronics reserves the right to make changes in product specification without notice or liability. All information is subject to TT Electronics' own data and is considered accurate at time of going to print.

TT Electronics | BI Technologies  
 Circulo de la Amistad #102 PIMSA IV Mexicali B.C. Mexico C.P 21210  
 Ph: +1 714 447 2345  
 www.ttelectronics.com/bi-technologies

### Outline Drawings

**MODEL EN11-HSM**  
(Top Adjust, with Switch, Threaded Bushing)

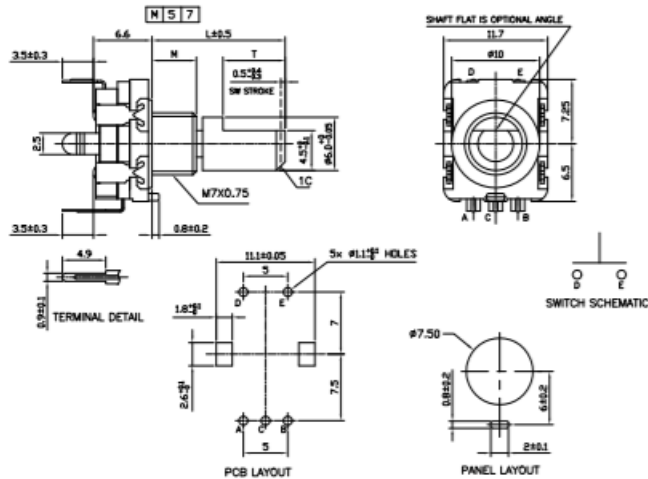

**MODEL EN11-HNM**  
(Top Adjust, without Switch, Threaded Bushing)

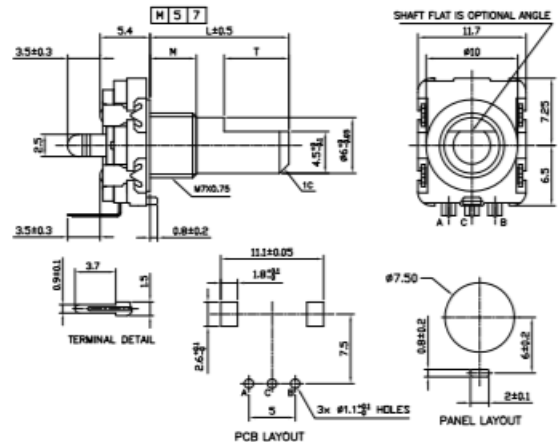

**MODEL EN11-HSB**  
(Top Adjust, with Switch, Plain Bushing)

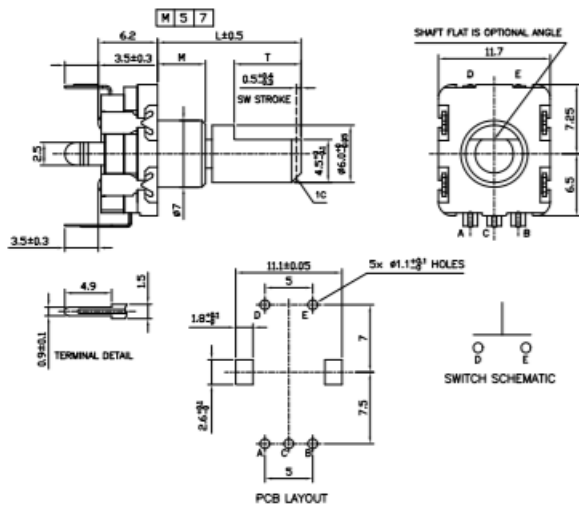

**MODEL EN11-HNB**  
(Top Adjust, without Switch, Plain Bushing)

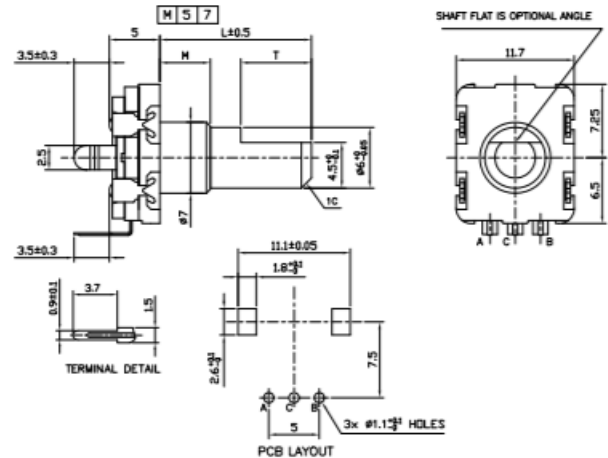

General Note  
TT Electronics reserves the right to make changes in product specification without notice or liability. All information is subject to TT Electronics' own data and is considered accurate at time of going to print.

TT Electronics | BI Technologies  
Circulo de la Amistad #102 PIMSA IV Mexicali B.C. Mexico C.P 21210  
Ph: +1 714 447 2345  
www.ttelectronics.com/bi-technologies

### Outline Drawings

**MODEL EN11-VSM**  
(Side Adjust, with Switch, Threaded Bushing)

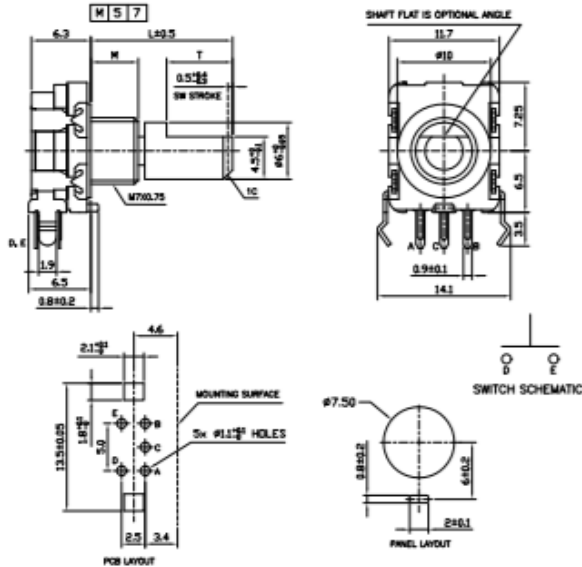

**MODEL EN11-VNM**  
(Side Adjust, without Switch, Threaded Bushing)

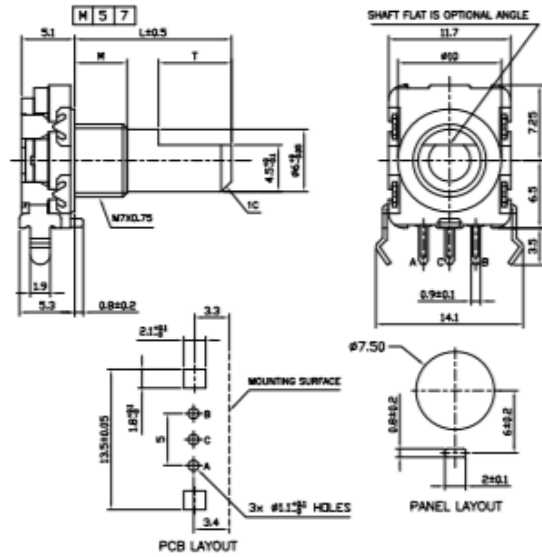

**MODEL EN11-VSB**  
(Side Adjust, with Switch, Plain Bushing)

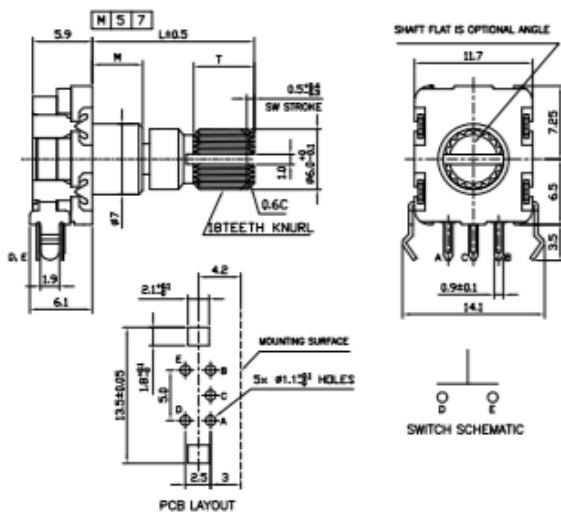

**MODEL EN11-VNB**  
(Side Adjust, without Switch, Plain Bushing)

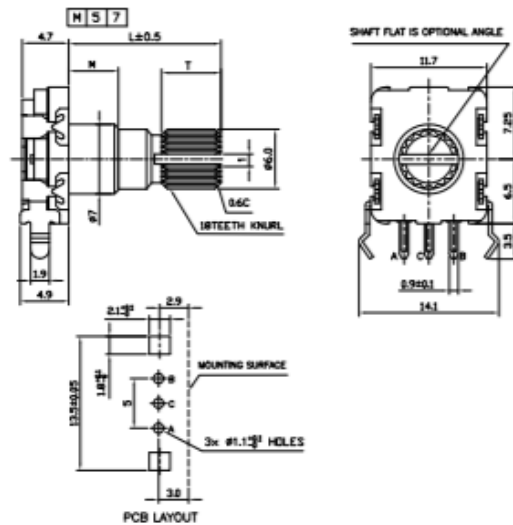

General Note  
TT Electronics reserves the right to make changes in product specification without notice or liability. All information is subject to TT Electronics' own data and is considered accurate at time of going to print.

TT Electronics | BI Technologies  
Circulo de la Amistad #102 PIMSA IV Mexicali B.C. Mexico C.P 21210  
Ph: +1 714 447 2345  
www.ttelectronics.com/bi-technologies

### Recommended Filter Schematic

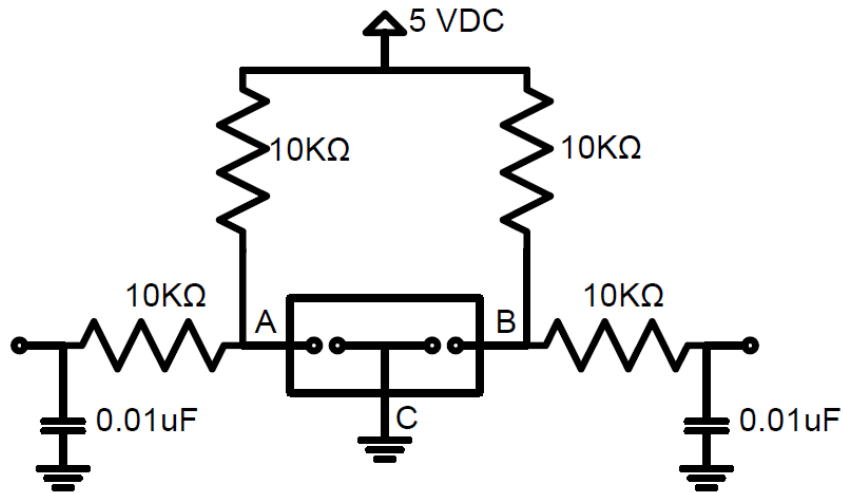

### Circuit Diagram

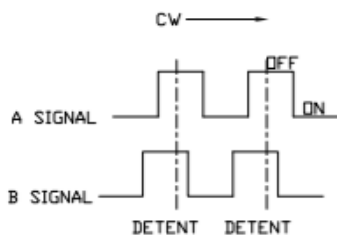

**For 20 PPR (B leads A)**

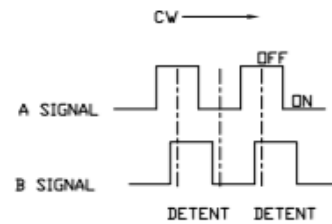

**For 15 PPR (A leads B)**