

P	LTR	DESCRIPTION	DATE	DWN	APVD
	A	INITIAL RELEASE	27OCT2022	E.C	Z.Z
	A1	REVISION (ECR-23-185088)	24AUG2023	S.W	Z.Z

	3 POSITION	2 POSITION	COLOR
CODING A	2392563-1 	1-2392563-1 	BLACK
CODING B	2392563-2 	1-2392563-2 	NATURAL
CODING C	2392563-3 	1-2392563-3 	BLUE
CODING D	2392563-4 	1-2392563-4 	PURPLE
CODING E	2392563-5 	1-2392563-5 	GREEN
CODING F	2392563-6 	1-2392563-6 	BROWN

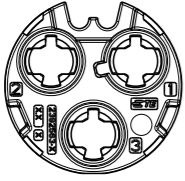

SCALE 1:1
2392563-1 AS SHOWN

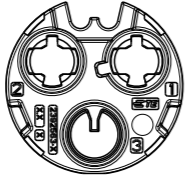
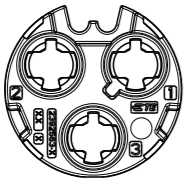
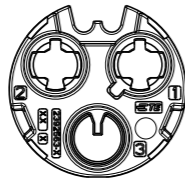
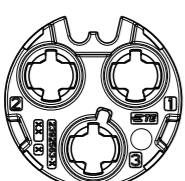
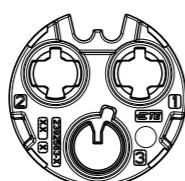
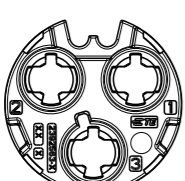
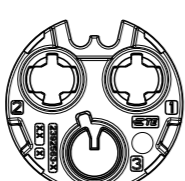
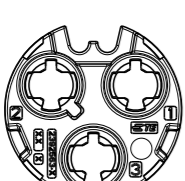
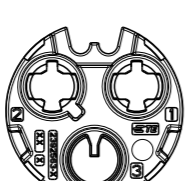
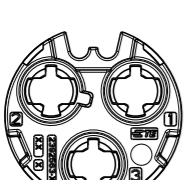
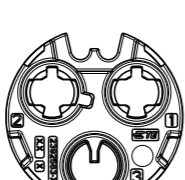
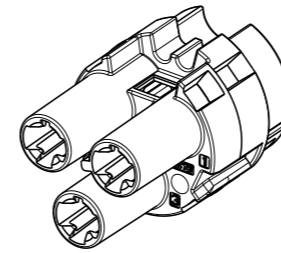
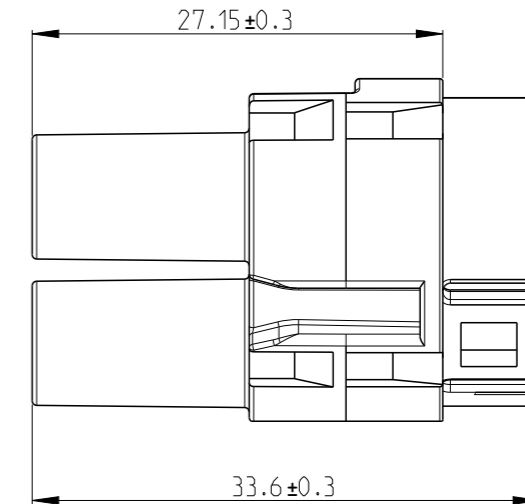
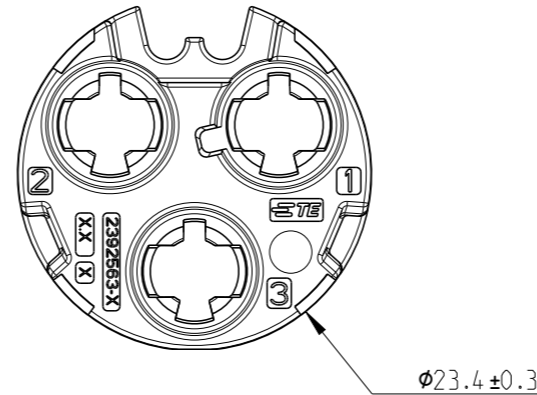

- MATERIAL: PA66 GF-30
FLAMMABILITY: UL94 V-0
COLOR: SEE TABLE
- FEATURE DENOTED BY REFERENCE DIMENSIONS MUST BE INSPECTION FOR PRESENCE
- PART MUST BE FREE OF EXCESSIVE FLASH, MIS-MATCH, SINK MARKS, OR OTHER VISUAL IMPERFECTIONS THAT MAY AFFECT PRODUCT FIT OR FUNCTION
- BULK PACKAGED

THIS DRAWING IS A CONTROLLED DOCUMENT.		DWN E.CHEN 22OCT2022	 TE Connectivity	
DIMENSIONS: mm		CHK J.LI 22OCT2022		
TOLERANCES UNLESS OTHERWISE SPECIFIED:		APVD Z.ZHOU 22OCT2022	NAME PLUG INNER HOUSING HVA-HD400 MULTI CORE PLUG	
0 PLC ± 1 PLC ± 2 PLC ± 3 PLC ± 4 PLC ± ANGLES ±		PRODUCT SPEC 108-160599	SIZE A3	
MATERIAL 1		APPLICATION SPEC 114-160337	CAGE CODE 00779	DRAWING NO C-2392563
FINISH -		WEIGHT -	RESTRICTED TO -	
CUSTOMER DRAWING			SCALE 2:1	SHEET 1 OF 1
			REV A1	