

**Highly insulated module****Features**

- Electrical features
  - $V_{CES} = 6500\text{ V}$
  - $I_{C\text{nom}} = 250\text{ A} / I_{CRM} = 500\text{ A}$
- Mechanical features
  - ALSiC base plate for increased thermal cycling capability
  - Extended storage temperature down to  $T_{stg} = -55\text{ °C}$
  - Package with enhanced insulation of 10.4 kV AC 60 s
  - Package with CTI > 600
  - High creepage and clearance distances

**Potential applications**

- Traction drives
- Medium-voltage converters

**Product validation**

- Qualified for industrial applications according to the relevant tests of IEC 60747, 60749 and 60068

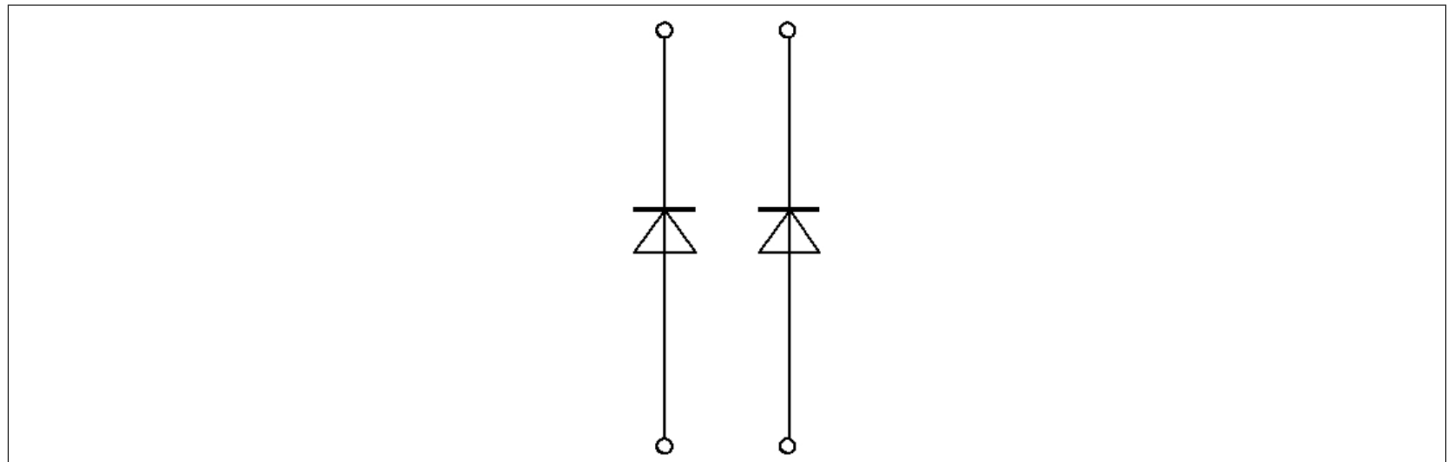
**Description**

## Table of contents

	<b>Description</b> .....	1
	<b>Features</b> .....	1
	<b>Potential applications</b> .....	1
	<b>Product validation</b> .....	1
	<b>Table of contents</b> .....	2
<b>1</b>	<b>Package</b> .....	3
<b>2</b>	<b>Diode, Inverter</b> .....	3
<b>3</b>	<b>Characteristics diagrams</b> .....	5
<b>4</b>	<b>Circuit diagram</b> .....	7
<b>5</b>	<b>Package outlines</b> .....	8
<b>6</b>	<b>Module label code</b> .....	9
	<b>Revision history</b> .....	10
	<b>Disclaimer</b> .....	11

## 1 Package

**Table 1** Insulation coordination

Parameter	Symbol	Note or test condition	Values	Unit
Isolation test voltage	$V_{ISOL}$	RMS, $f = 50$ Hz, $t = 60$ s	10.4	kV
Partial discharge extinction voltage	$V_{isol}$	RMS, $f = 50$ Hz, $Q_{PD}$ typ. 10 pC	5.1	kV
DC stability	$V_{CE(D)}$	$T_{vj}=25^{\circ}\text{C}$ , 100 Fit	3800	V
Material of module baseplate			AlSiC	
Internal isolation		basic insulation (class 1, IEC 61140)	AlN	
Creepage distance	$d_{Creep}$	terminal to heatsink	64.0	mm
Creepage distance	$d_{Creep}$	terminal to terminal	56.0	mm
Clearance	$d_{Clear}$	terminal to heatsink	40.0	mm
Clearance	$d_{Clear}$	terminal to terminal	26.0	mm
Comparative tracking index	$CTI$		> 600	

**Table 2** Characteristic values

Parameter	Symbol	Note or test condition	Values			Unit	
			Min.	Typ.	Max.		
Stray inductance module	$L_{sCE}$			25		nH	
Module lead resistance, terminals - chip	$R_{AA'+CC'}$	$T_C=25^{\circ}\text{C}$ , per switch		0.36		mΩ	
Storage temperature	$T_{stg}$		-55		125	°C	
Mounting torque for module mounting	$M$	- Mounting according to valid application note	M6, Screw	4.25		5.75	Nm
Terminal connection torque	$M$	- Mounting according to valid application note	M8, Screw	8		10	Nm
Weight	$G$			500		g	

Note: Dynamic data valid in conjunction with FZ250R65KE3 module

## 2 Diode, Inverter

**Table 3** Maximum rated values

Parameter	Symbol	Note or test condition	Values	Unit
Repetitive peak reverse voltage	$V_{RRM}$	$T_{vj} = -50^{\circ}\text{C}$	5900	V
		$T_{vj} = 25^{\circ}\text{C}$	6500	
		$T_{vj} = 125^{\circ}\text{C}$	6500	

(table continues...)

**Table 3 (continued) Maximum rated values**

Parameter	Symbol	Note or test condition	Values	Unit	
Continuous DC forward current	$I_F$		250	A	
Repetitive peak forward current	$I_{FRM}$	$t_P = 1 \text{ ms}$	500	A	
$I^2t$ - value	$I^2t$	$t_P = 10 \text{ ms}, V_R = 0 \text{ V}$	$T_{vj} = 125 \text{ }^\circ\text{C}$	52	$\text{kA}^2\text{s}$
Maximum power dissipation	$P_{RQM}$		$T_{vj} = 125 \text{ }^\circ\text{C}$	1000	kW
Minimum turn-on time	$t_{onmin}$		10	$\mu\text{s}$	

**Table 4 Characteristic values**

Parameter	Symbol	Note or test condition	Values			Unit
			Min.	Typ.	Max.	
Forward voltage	$V_F$	$I_F = 250 \text{ A}, V_{GE} = 0 \text{ V}$	$T_{vj} = 25 \text{ }^\circ\text{C}$	3.00	3.50	V
			$T_{vj} = 125 \text{ }^\circ\text{C}$	2.95	3.50	
Peak reverse recovery current	$I_{RM}$	$V_R = 3600 \text{ V}, I_F = 250 \text{ A}, V_{GE} = -15 \text{ V}, -di_F/dt = 1000 \text{ A}/\mu\text{s} (T_{vj} = 125 \text{ }^\circ\text{C})$	$T_{vj} = 25 \text{ }^\circ\text{C}$	370		A
			$T_{vj} = 125 \text{ }^\circ\text{C}$	400		
Recovered charge	$Q_r$	$V_R = 3600 \text{ V}, I_F = 250 \text{ A}, V_{GE} = -15 \text{ V}, -di_F/dt = 1000 \text{ A}/\mu\text{s} (T_{vj} = 125 \text{ }^\circ\text{C})$	$T_{vj} = 25 \text{ }^\circ\text{C}$	290		$\mu\text{C}$
			$T_{vj} = 125 \text{ }^\circ\text{C}$	540		
Reverse recovery energy	$E_{rec}$	$V_R = 3600 \text{ V}, I_F = 250 \text{ A}, V_{GE} = -15 \text{ V}, -di_F/dt = 1000 \text{ A}/\mu\text{s} (T_{vj} = 125 \text{ }^\circ\text{C})$	$T_{vj} = 25 \text{ }^\circ\text{C}$	470		mJ
			$T_{vj} = 125 \text{ }^\circ\text{C}$	1000		
Thermal resistance, junction to case	$R_{thJC}$	per diode			55.8	K/kW
Thermal resistance, case to heat sink	$R_{thCH}$	per diode		42.0		K/kW
Temperature under switching conditions	$T_{vj op}$		-50		125	$^\circ\text{C}$

### 3 Characteristics diagrams

**Forward characteristic (typical), Diode, Inverter**

$$I_F = f(V_F)$$

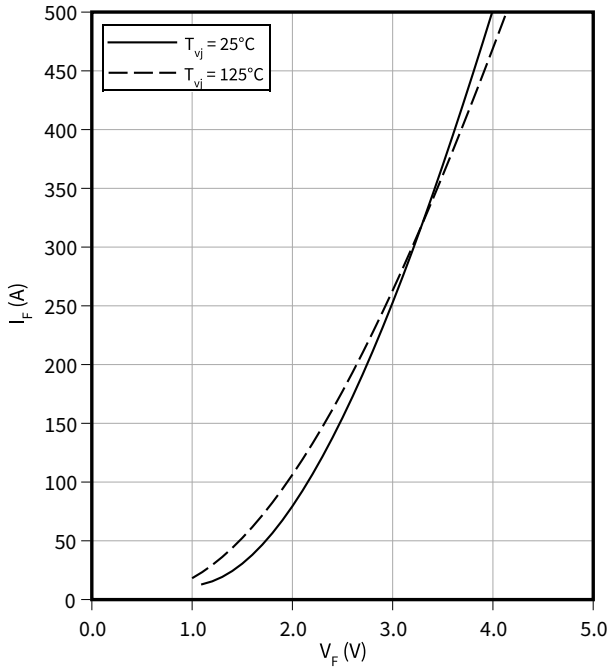

**Switching losses (typical), Diode, Inverter**

$$E_{rec} = f(I_F)$$

$$V_{CE} = 3600 \text{ V}, R_{Gon} = R_{Gon}(\text{IGBT})$$

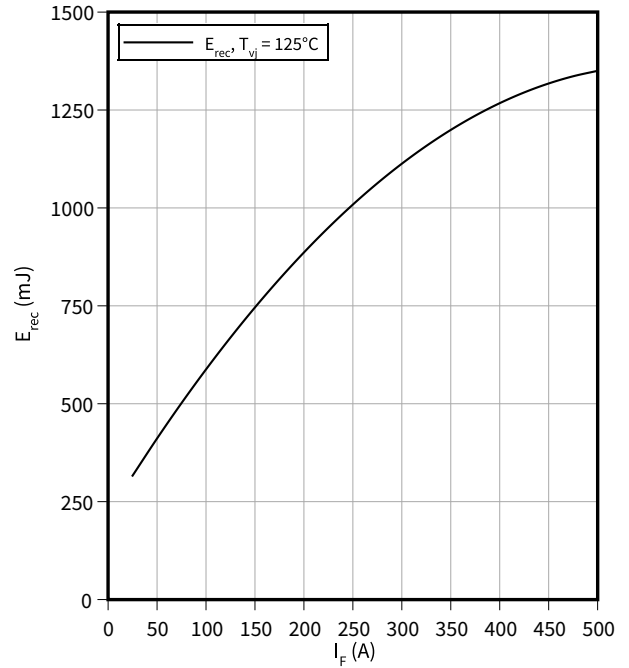

**Switching losses (typical), Diode, Inverter**

$$E_{rec} = f(R_G)$$

$$V_{CE} = 3600 \text{ V}, I_F = 250 \text{ A}$$

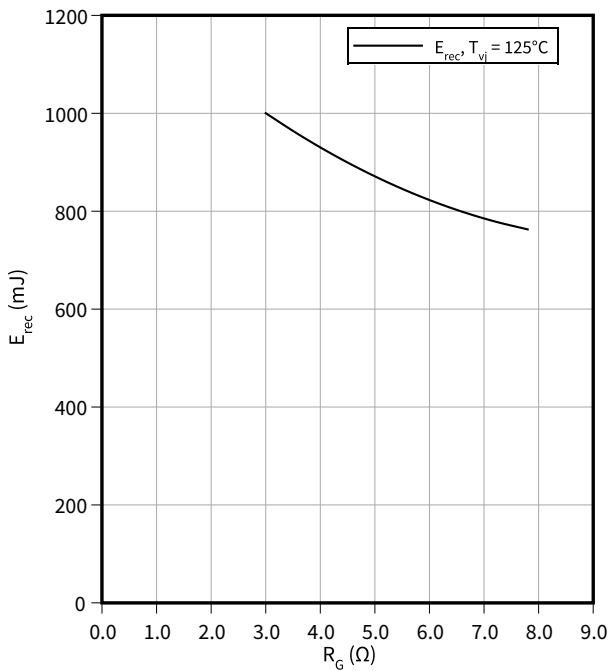

**Transient thermal impedance, Diode, Inverter**

$$Z_{th} = f(t)$$

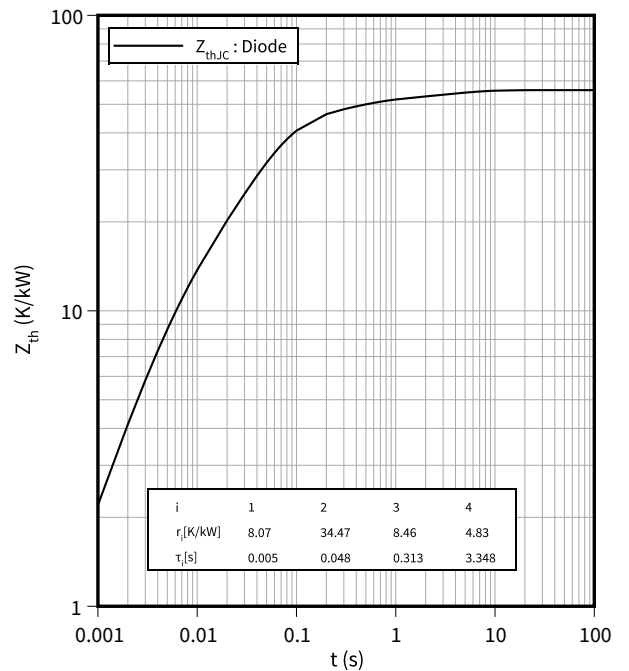

**Safe operating area (SOA), Diode, Inverter**

$$I_R = f(V_R)$$

$$T_{vj} = 125\text{ °C}$$

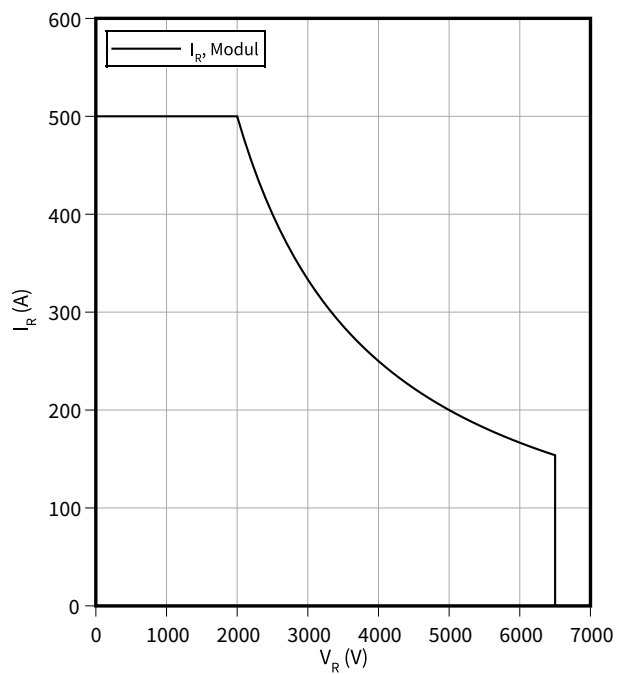

## 4 Circuit diagram

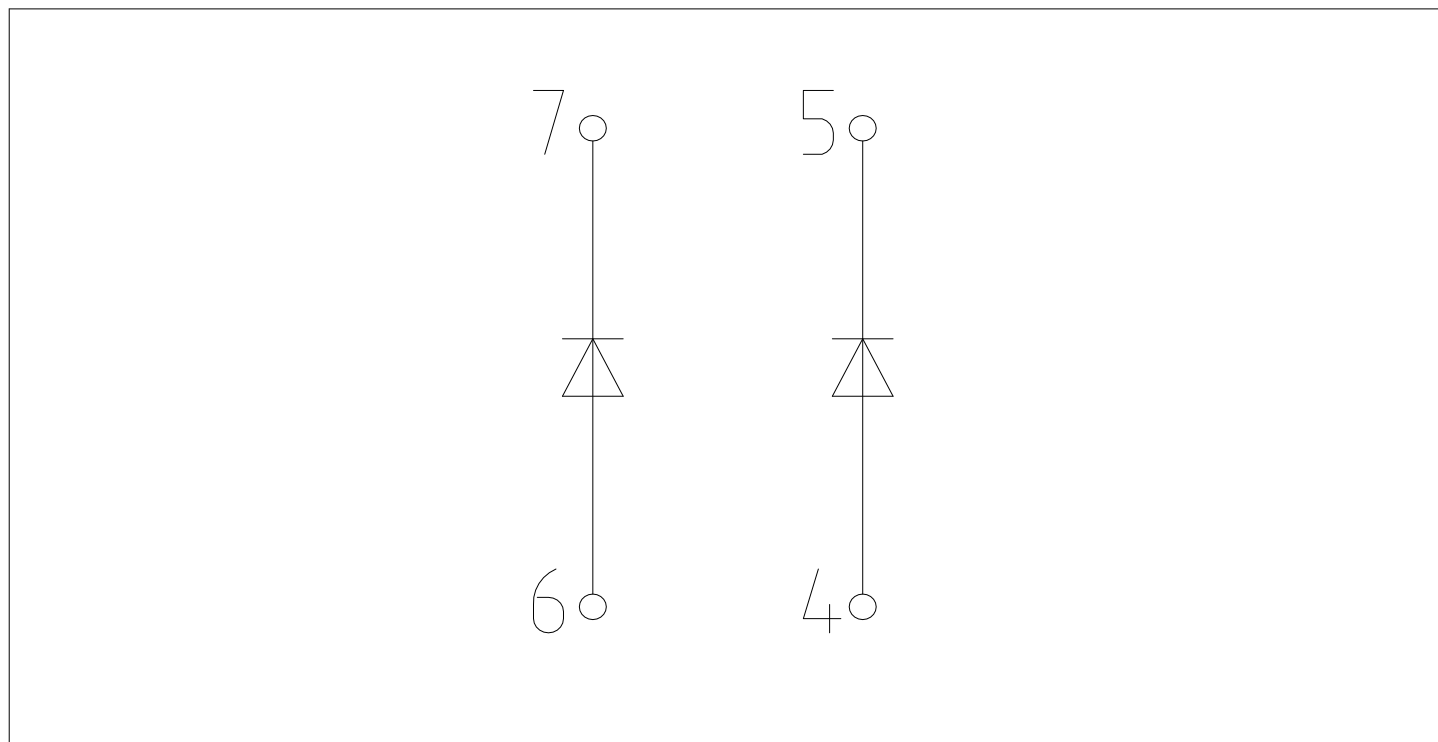

**Figure 1**

**5 Package outlines**

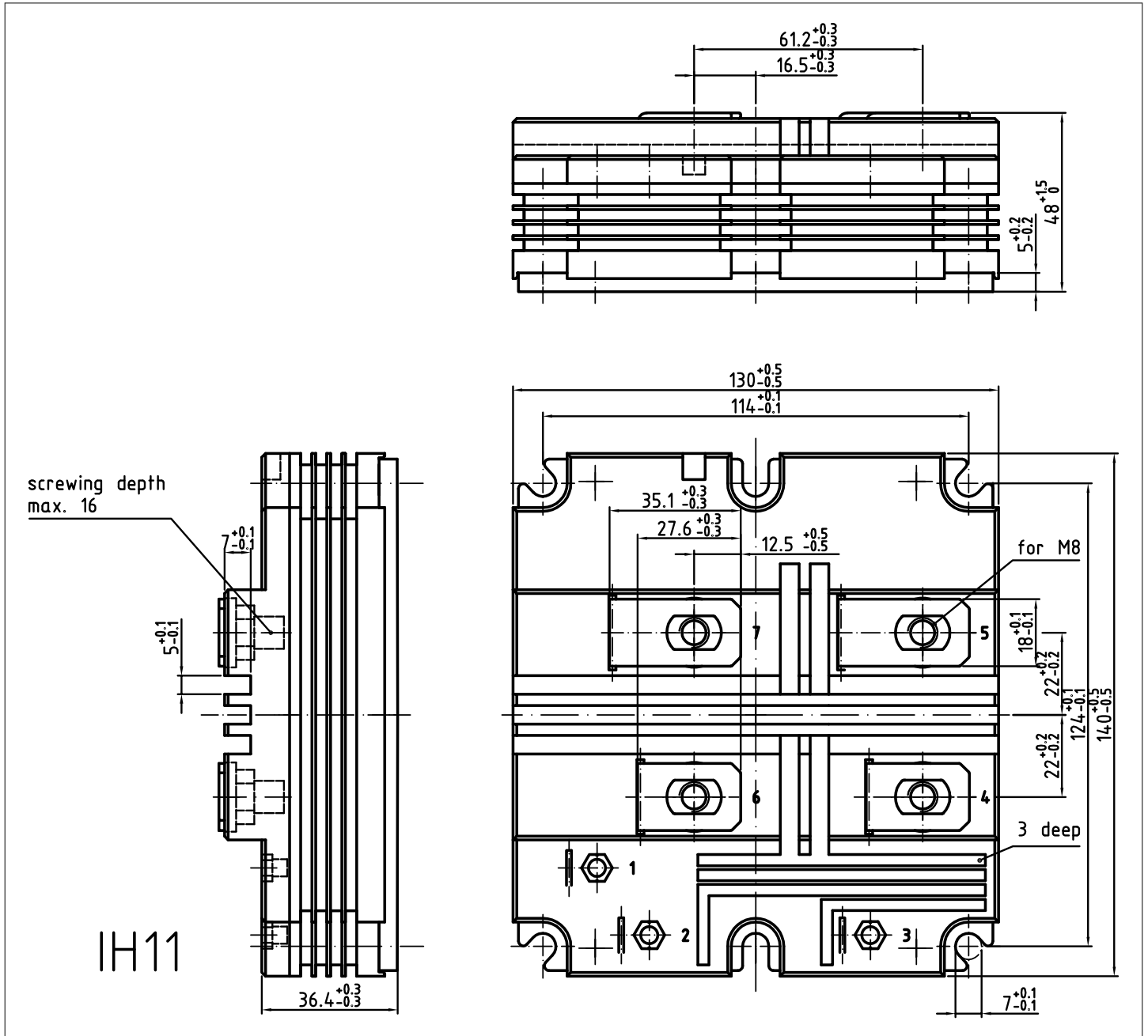

**Figure 2**

## 6 Module label code

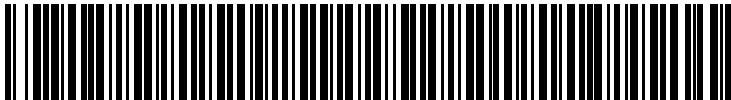
Module label code			
Code format	Data Matrix	Barcode Code128	
Encoding	ASCII text	Code Set A	
Symbol size	16x16	23 digits	
Standard	IEC24720 and IEC16022	IEC8859-1	
Code content	<i>Content</i>	<i>Digit</i>	<i>Example</i>
	Module serial number	1 - 5	71549
	Module material number	6 - 11	142846
	Production order number	12 - 19	55054991
	Date code (production year)	20 - 21	15
	Date code (production week)	22 - 23	30
Example	 		
	71549142846550549911530		71549142846550549911530

**Figure 3**

## Revision history

Document revision	Date of release	Description of changes
V1.0	2012-07-13	Target datasheet
V2.0	2012-07-16	Preliminary datasheet
V3.0	2014-06-16	Final datasheet
V3.1	2018-01-15	Final datasheet
n/a	2020-09-01	Datasheet migrated to a new system with a new layout and new revision number schema: target or preliminary datasheet = 0.xy; final datasheet = 1.xy
1.10	2022-04-12	Final datasheet

## Trademarks

All referenced product or service names and trademarks are the property of their respective owners.

**Edition 2022-04-12**

**Published by**

**Infineon Technologies AG**

**81726 Munich, Germany**

**© 2022 Infineon Technologies AG**

**All Rights Reserved.**

**Do you have a question about any aspect of this document?**

**Email: [erratum@infineon.com](mailto:erratum@infineon.com)**

**Document reference**

**IFX-AAX136-005**

## IMPORTANT NOTICE

The information given in this document shall in no event be regarded as a guarantee of conditions or characteristics ("Beschaffenhheitsgarantie").

With respect to any examples, hints or any typical values stated herein and/or any information regarding the application of the product, Infineon Technologies hereby disclaims any and all warranties and liabilities of any kind, including without limitation warranties of non-infringement of intellectual property rights of any third party.

In addition, any information given in this document is subject to customer's compliance with its obligations stated in this document and any applicable legal requirements, norms and standards concerning customer's products and any use of the product of Infineon Technologies in customer's applications.

The data contained in this document is exclusively intended for technically trained staff. It is the responsibility of customer's technical departments to evaluate the suitability of the product for the intended application and the completeness of the product information given in this document with respect to such application.

## WARNINGS

Due to technical requirements products may contain dangerous substances. For information on the types in question please contact your nearest Infineon Technologies office.

Except as otherwise explicitly approved by Infineon Technologies in a written document signed by authorized representatives of Infineon Technologies, Infineon Technologies' products may not be used in any applications where a failure of the product or any consequences of the use thereof can reasonably be expected to result in personal injury.