

ULTRA MINIATURE RELAY 2 POLE - 2A (SLIM PROFILE SIGNAL RELAY)

FTR-B4 Series

RoHS Compliant



■ FEATURES

- DPDT 2c
- Ultra miniature slim type relay for surface mounting
 - Height: 9.3mm maximum (THT), 10mm maximum (SMT)
 - Weight: Approximately 1.0 g
- UL, CSA recognized
- Conforms to Telcordia/FCC Part 68 spacing and high breakdown voltage
 - Creepage: 1.6mm
 - Dielectric strength: 1,500V (coil to contacts)
 - Surge strength: 2,500V
- High reliable bifurcated gold overlay silver contact
- Low power consumption: 140mW (standard), 100mW (latching)
- RoHS compliant
- Plastic sealed

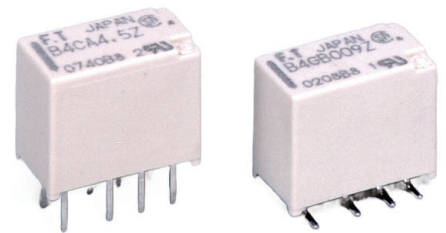

■ APPLICATIONS

xDSL, modems, digital equipment (signal switching), STB (line switching), car navigation system (audio switching)

■ PART NUMBERS

[Example] FTR-B4 G A 4.5 Z - B05

(a) (b) (c) (d) (e) (f)

(a)	Relay type	FTR-B4 series
(b)	Terminal type	C : Through hole G : Surface mount S : Surface mount, space saving
(c)	Coil type	A : Standard type (non-latching) B : Latching type (1 coil)
(d)	Coil rated voltage	4.5 : 1.5...24 VDC Please refer to coil rating table
(e)	Contact material	Z : Gold overlay silver nickel (standard) P : Gold overlay silver palladium
(f)	Packaging	Nil : Tube packaging B05 : Tape & reel packaging (only for surface mount type)

Remarks: Actual marking on relay would not carry code FTR and be as below: Ordering code: FTR-B4GA012Z-B10 Actual marking: B4GA012Z

■ SPECIFICATIONS

Item		Specifications		Remarks/Conditions	
		Standard type: FTR-B4()A	Latching type: FTR-B4()B		
Contact Data	Configuration	2c (2 Form C)			
	Construction	Bifurcated contacts			
	Material	Z: Gold overlay silver nickel P: Gold overlay silver palladium			
	Resistance (initial)	Max. 100 mΩ		At 1A, 6VDC	
	Contact rating	1A, 30VDC / 0.3A, 125VAC		Resistive	
	Max. carrying current	2A			
	Max. switching voltage	250VAC/220VDC			
	Max. switching power	62.5VA/30W			
	Min. switching load *	0.01mA, 10mVDC		Reference	
Coil	Rated power	140mW to 230mW	100mW to 130mW	At 20°C	
	Applied pulse width	-	Min. 10ms	At 20°C	
	Operate power	80mW to 130mW	57mW to 68mW	At 20°C	
	Operating temperature rise	-40 °C to +85 °C		No frost	
	Storage temperature / humidity	-40 °C to +85 °C / 5% to 85% RH		No frost	
Time	Operate	Max. 3 ms	Max. 3ms (set)	At nominal voltage, without bounce	
	Release	Max. 3 ms	Max. 3ms (reset)	At nominal voltage, without bounce	
Life	Mechanical	Min. 50 x 10 ⁶ operations	Min. 20 x 10 ⁶ operations		
	Electrical	DC load	Min. 100 x 10 ³ operations	At 1A, 30VDC	
		AC load	Min. 100 x 10 ³ operations	At 0.3A, 125VAC	
Insulation	Insulation resistance (initial)	Min. 1,000MΩ		At 500VDC	
	Dielectric strength	Open contacts	1,000VAC (50/60Hz) 1 minute		
		Adjacent contacts	1,000VAC (50/60Hz) 1 minute		
		Contact to coil	1,500VAC (50/60Hz) 1 minute		
	Surge strength	Contact to coil	2,500V, 2 x 10μs standard wave		
	Clearance	Open contacts	0.28mm		
		Adjacent contacts	1.0mm		
		Contact to coil	1.0mm		
	Creepage	Open contacts	0.28mm		
		Adjacent contacts	1.0mm		
Contact to coil		1.6mm			
Others	Vibration resistance	Misoperation	10 to 55 to 10Hz single amplitude 1.65mm	Coil ON/OFF, 3 axis, total 6 cycles	
		Endurance	10 to 55 to 10Hz single amplitude 2.5mm	Coil OFF, 3 axis, total 6 hours	
	Shock resistance	Misoperation	750m/s ² (11 ±1ms)	Coil ON/OFF, 3 axis, total 36 operations	
		Endurance	1,000m/s ² (6 ±1ms)	Coil OFF, 3 axis, total 18 operations	
	Dimensions / Weight	5.7 x 10.6 x 9.0mm / Approx. 1.0g			
	Sealing	RT III (plastic sealed)			

* Minimum switching loads mentioned above are reference values. Please perform the confirmation test with actual load before production since reference values may vary according to switching frequencies, environmental conditions and expected reliability levels.

■ COIL DATA

Standard type

Coil Code	Rated Coil Voltage (VDC)	Coil Resistance (Ω) $\pm 10\%$	Must Operate Voltage ^{*1} (VDC)	Must Release Voltage ^{*1} (VDC)	Rated Power (mW)
1.5	1.5	16.1	1.13	0.15	140
003	3	64.3	2.25	0.3	
4.5	4.5	145	3.38	0.45	
006	6	257	4.5	0.6	
009	9	579	6.75	0.9	
012	12	1,028	9.0	1.2	
024	24	2,504	18.0	2.4	230

Latching type (1 coil)

Coil Code	Rated Coil Voltage (VDC)	Coil Resistance (Ω) $\pm 10\%$	Set Voltage ^{*1} (VDC)	Reset Voltage ^{*1} (VDC)	Set/Reset Current (mA)	Rated power (mW)
1.5	1.5	22.5	+1.13	-1.13	50	100
003	3	90	+2.25	-2.25	25	
4.5	4.5	203	+3.38	-3.38	17	
006	6	360	+4.5	-4.5	13	
009	9	810	+6.75	-6.75	8	
012	12	1,440	+9.0	-9.0	6	
024	24	4,800	+18.0	-18.0	4	120

Note: All values in the table are valid at 20°C and zero contact.

*: Specified operate values are valid for pulse wave voltage.

■ SAFETY STANDARDS

Type	Compliance	Contact rating
UL	Flammability: UL 94-V0 (plastics)	
	UL508 File No.E63615	0.5A, 125VAC (resistive) 1A, 30VDC
CSA	C22.2 No.14	0.3A, 110VDC
	File No.LR40304	2A, 30VDC

Comply with Telcordia specifications and FCC part 68 and meet BSI EN60950-1: Marking only for UL, CSA

■ DIMENSIONS

FTR-B4C - Through hole type

• Dimensions

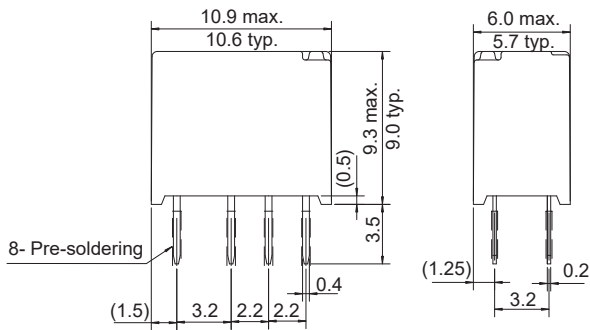

• Schematics *
(BOTTOM VIEW)

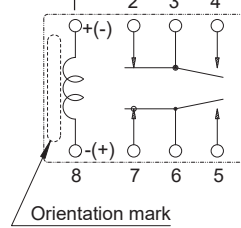

• PC board mounting hole layout
(BOTTOM VIEW)

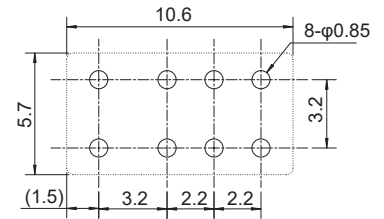

FTR-B4G - Surface mount type

• Dimensions

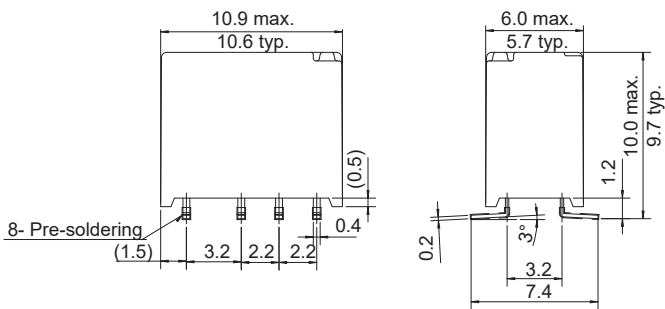

• Schematics *
(TOP VIEW)

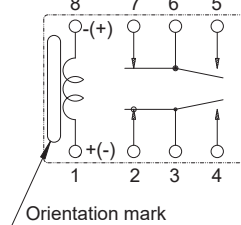

• PC board mounting pad layout
(TOP VIEW)

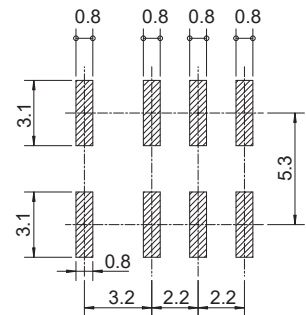

FTR-B4S - Space saving surface mount type

• Dimensions

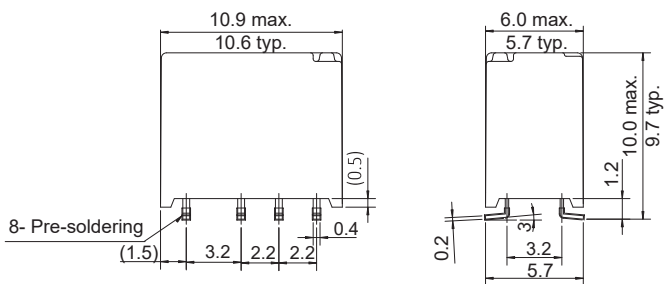

• Schematics *
(TOP VIEW)

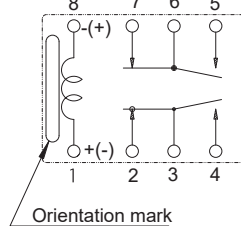

• PC board mounting hole layout
(TOP VIEW)

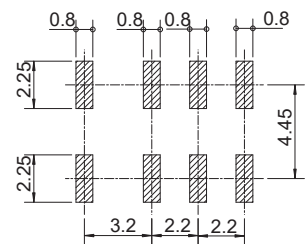

*: Contacts indicates reset state for latching relays (FTR-B4CB, FTR-B4GB and FTR-B4SB versions) and non-operate state for standard relays (FTR-B4CA, FTR-B4GA and FTR-B4SA versions).

*: +/-: Apply set voltage for latching relays, operate voltage for standard relays.

(+)/(-): Indicates set state for latching relays, operate state for standard relays.

Note: Tolerance for PC board mounting hole/pad layout: ± 0.1 .

Note: Dimensions of the terminals do not include thickness of pre-soldering.

Unit: mm
(): Reference

■ COIL POLARITY LATCHING TYPE

Coil terminal	1	8
Set	+	-
Reset	-	+

■ PACKAGING SPECIFICATIONS

(1) Packaging method

- Packaging standard: JIS C 0806
- Taping type: TB2412
- Reel type: R24D
- Quantity of 1 reel: 500pcs

• Packaging orientation code: B

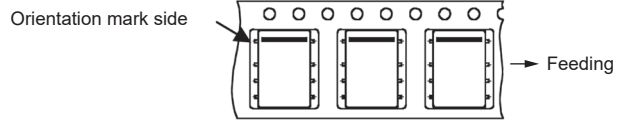

(2) Reel dimensions

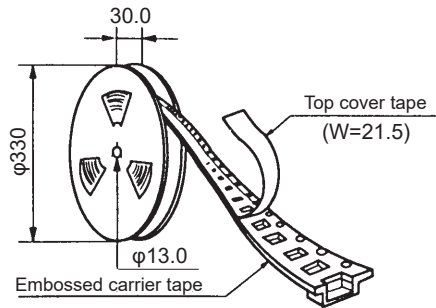

• Tape dimensions

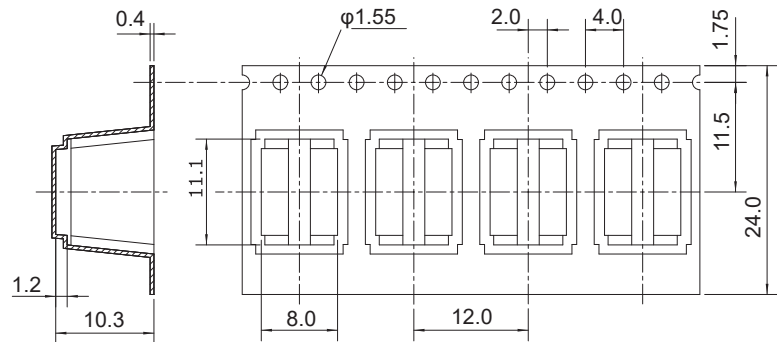

Note:

Relays are sold in 500 pieces per box. Minimum order quantity is 1,000 pieces for tube packing and 500 pieces for tape & reel packing.

Unit: mm

■ PART NUMBER LIST

Part Number	Coil Type	Terminal Type	Contact Material	Packaging	
FTR-B4CA()Z	Standard (Non latching)	Through hole	Gold overlay silver nickel	Tube	
FTR-B4CA()P			Gold overlay silver palladium		
FTR-B4GA()Z		Surface mount	Surface mount	Gold overlay silver nickel	Tube
FTR-B4GA()Z-B05				Gold overlay silver palladium	Tape & reel
FTR-B4GA()P			Surface mount, space saving	Gold overlay silver nickel	Tube
FTR-B4GA()P-B05				Gold overlay silver palladium	Tape & reel
FTR-B4SA()Z		Surface mount, space saving	Surface mount, space saving	Gold overlay silver nickel	Tube
FTR-B4SA()Z-B05				Gold overlay silver palladium	Tape & reel
FTR-B4SA()P		Surface mount, space saving	Surface mount, space saving	Gold overlay silver nickel	Tube
FTR-B4SA()P-B05				Gold overlay silver palladium	Tape & reel
FTR-B4CB()Z	Latching (1 coil)	Through hole	Gold overlay silver nickel	Tube	
FTR-B4CB()P			Gold overlay silver palladium		
FTR-B4GB()Z		Surface mount	Surface mount	Gold overlay silver nickel	Tube
FTR-B4GB()Z-B05				Gold overlay silver palladium	Tape & reel
FTR-B4GB()P			Surface mount, space saving	Gold overlay silver nickel	Tube
FTR-B4GB()P-B05				Gold overlay silver palladium	Tape & reel
FTR-B4SB()Z		Surface mount, space saving	Surface mount, space saving	Gold overlay silver nickel	Tube
FTR-B4SB()Z-B05				Gold overlay silver palladium	Tape & reel
FTR-B4SB()P			Surface mount, space saving	Gold overlay silver nickel	Tube
FTR-B4SB()P-B05				Gold overlay silver palladium	Tape & reel

CHARACTERISTIC DATA

(Characteristic data is not guaranteed value but measured values of samples from production line.)

Standard type

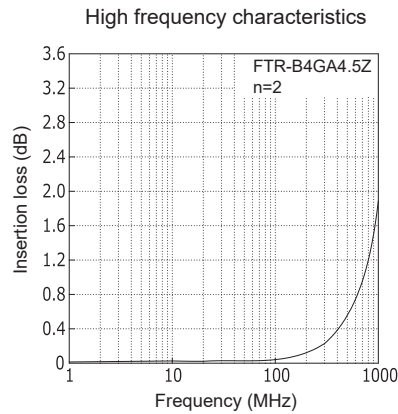
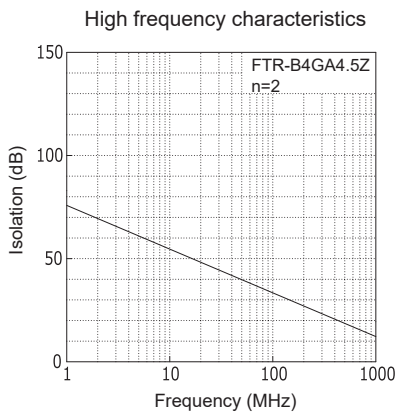
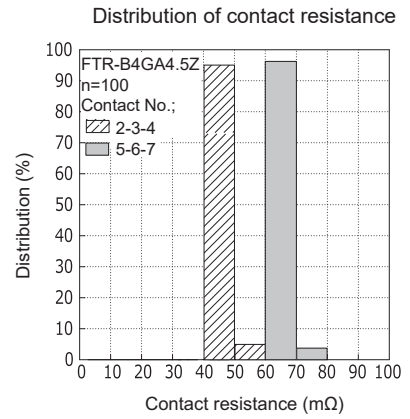
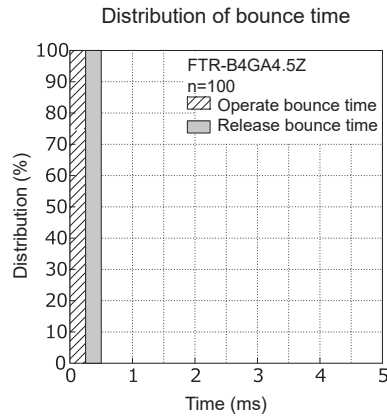
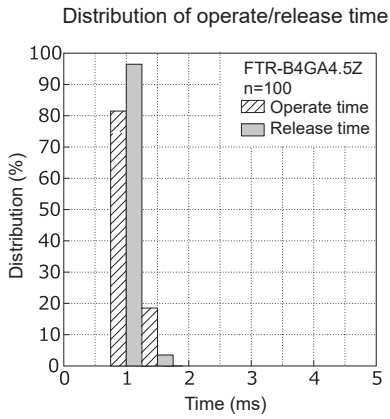
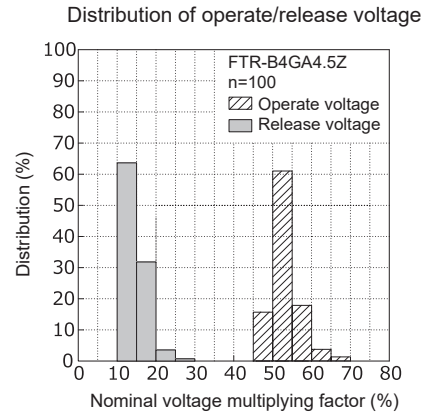
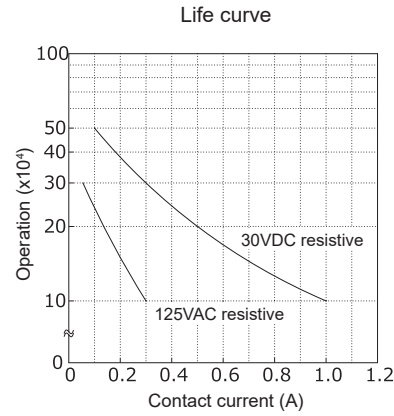
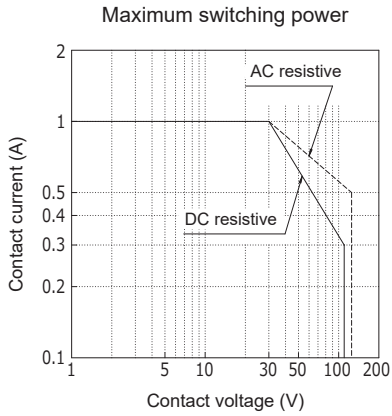
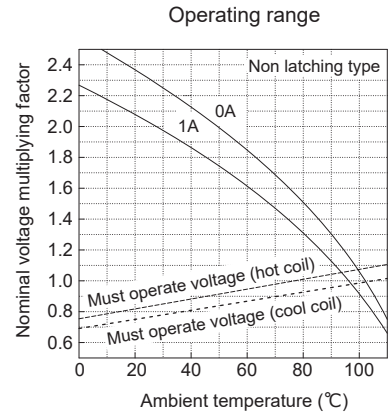
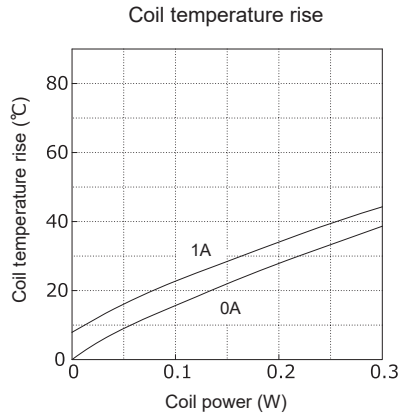
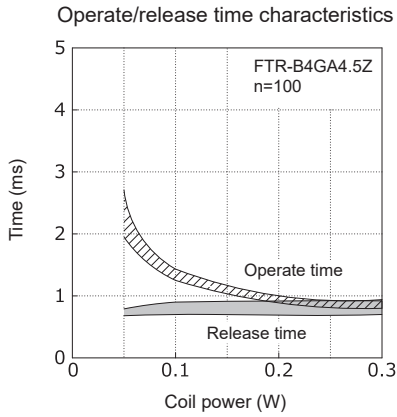

CHARACTERISTIC DATA

(Characteristic data is not guaranteed value but measured values of samples from production line.)

Latching type

Set/reset time characteristics

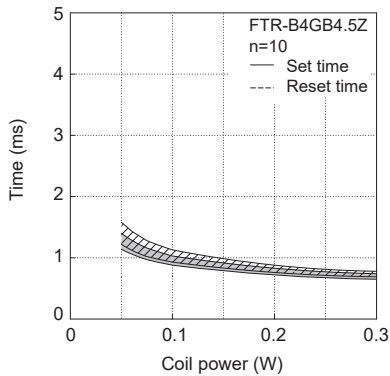

Pulse characteristics

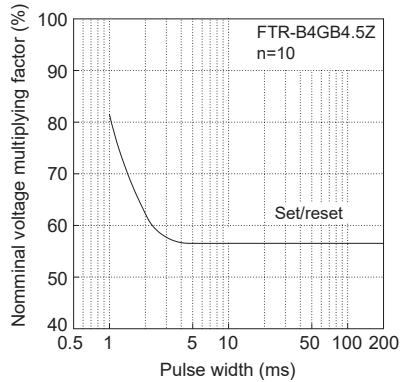

Coil temperature rise

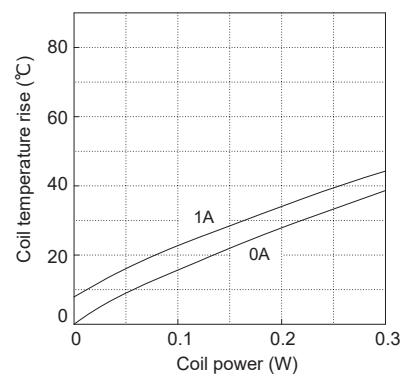

Operating range

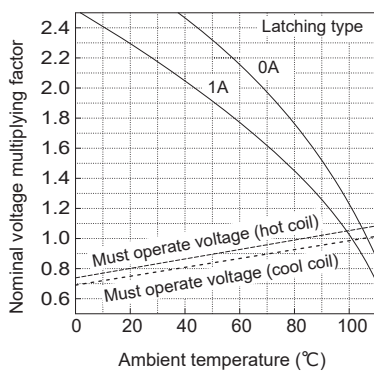

Maximum switching power

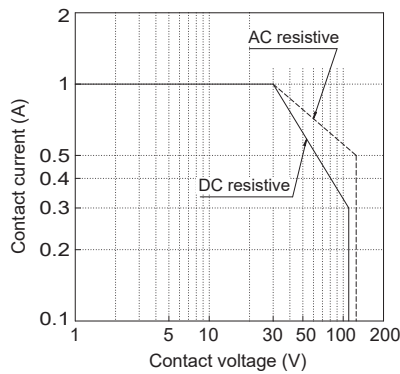

Life curve

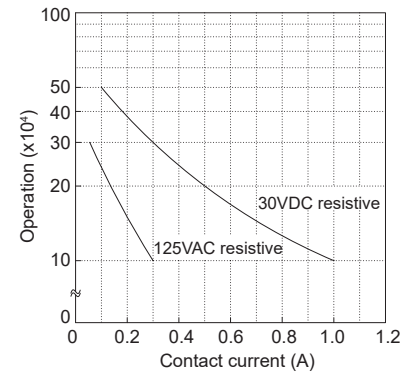

Distribution of set/reset voltage

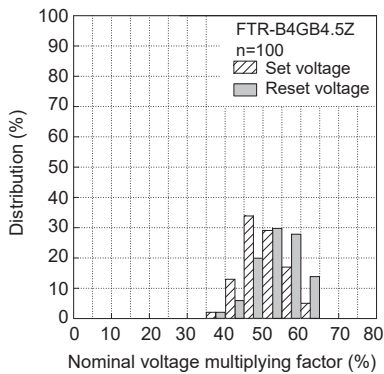

Distribution of set/reset time

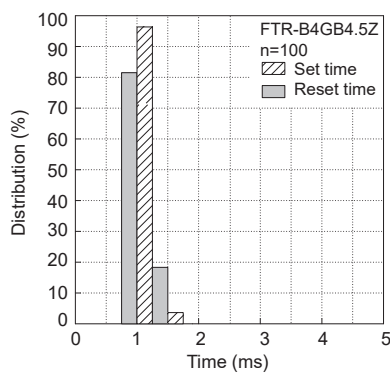

Distribution of bounce time

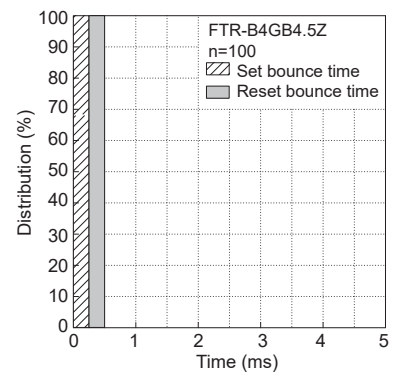

Distribution of contact resistance

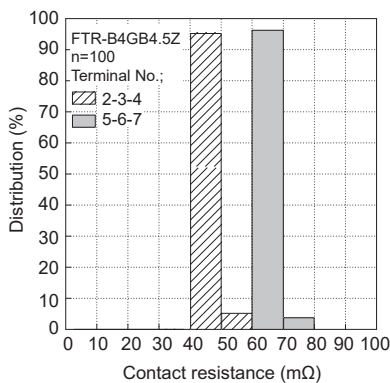

High frequency characteristics

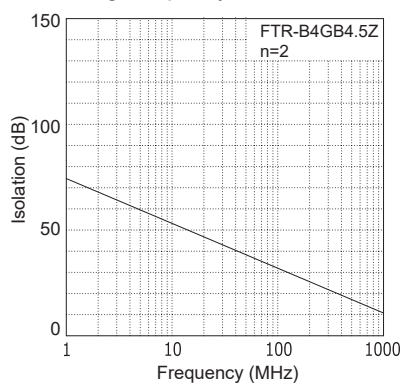

High frequency characteristics

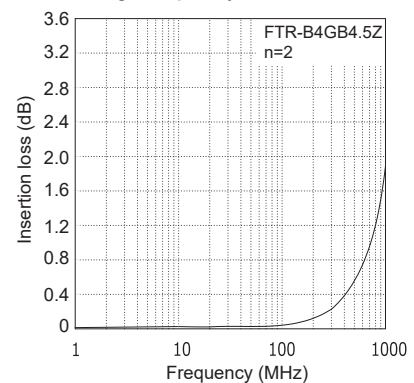

CAUTIONS

- All values mentioned in this datasheet are provided under ideal conditions. Please perform the confirmation test before actual use.
- Reflow soldering is not available with through hole type.
- Do not use relays in the atmosphere with sulfide gas, chloride gas or nitric oxide. Contact resistance may increase.
- Do not use silicon or silicon-containing product or materials near relays. It may cause contact failure.

Notes for latching relays

- Latching relays are shipped in the state reset, but state may change due to shock during transportation or mounting. Before using the relays, it is advisable to bring the relays in necessary state (set or reset) and program a circuit sequence. Otherwise, it will or will not operate simultaneously with power activation.
- Please connect relay coils according to specified polarity.
- Do not apply voltage to both set coil and reset coil at a time.

GENERAL INFORMATION

1. RoHS Compliance

- All relays produced by FCL Components are compliant with RoHS directive 2011/65/EU, including commission delegated directive 2015/863.

2. Recommended lead free solder condition

Flow Solder Condition:

Pre-Heating: Maximum 120°C within 90 sec.
Soldering: Dip within 5 sec. at 255°C±5°C solder bath

Relay must be cooled by air immediately after soldering

Solder by Soldering Iron:

Soldering Iron: 30-60W
Temperature: Maximum 350-360°C
Duration: Maximum 3 sec.

Reflow Solder Condition:

(Applicable only for reflow capable type)

Recommended reflow soldering profile: IRS (infrared reflow soldering)

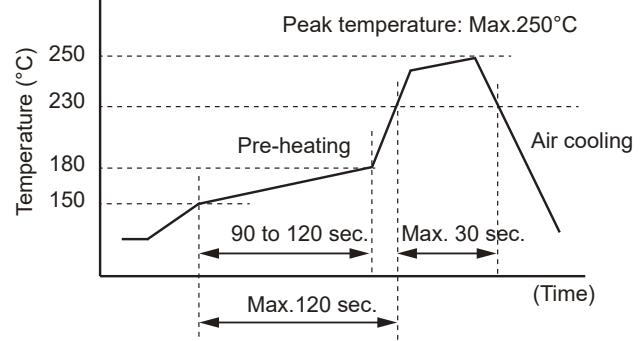

Important notes for reflow soldering

- Temperature shall be measured at PC board upper surface.
- Temperature at PC board upper surface may be changed depending on size of PC board, components mounted on the PC board and/or heating method. Please perform the confirmation test with actual PC board.
- This reflow condition is applicable only for reflow-capable relays. Do not reflow reflow-incapable relays.
- Recommended solder for assembly: Sn-3.0 Ag -0.5 Cu.

We highly recommend that you confirm your actual solder conditions

3. Moisture Sensitivity

- SMT versions of FTR-B4 relays in Tape & Reel package will be shipped in Moisture Barrier Bag (MBB).
- Moisture Sensitivity Level (MSL) of FTR-B4 relay is indicated on the packing caution label.
- Relays must be stored in the unopened MBB at storage conditions <40°C/90% RH for a maximum 1 year.
- SMT versions of FTR-B4 relays in tube packing will not be shipped in MBB. Therefore, these relays shall be dried by baking before reflow soldering process according to IPC/Jedex J-STD-033.

4. Tin Whiskers

- Dipped SnAgCu solder is known as presenting a low risk to tin whisker development. No considerable length whisker was found by our in-house test.

Contact

Japan

FCL COMPONENTS LIMITED
Shinagawa Seaside Park Tower
12-4, Higashi-shinagawa 4-chome,
Tokyo 140 0002, Japan
Tel: +81-3-3450-1682
Email: fcl-contact@cs.fcl-components.com

North and South America

FCL COMPONENTS AMERICA, INC.
2055 Gateway Place Suite 480,
San Jose, CA 95110 USA
Tel: +1-408-745-4900
Email: contact@fcl-components.us

Europe

FCL COMPONENTS EUROPE B.V.
Diamantlaan 25
2132 WV Hoofddorp, Netherlands
Tel: +31-23-556-0910
Email: info.fceu@cs.fcl-components.com

Asia Pacific

FCL COMPONENTS ASIA PTE LTD.
51 Changi Business Park Central 2, #06-07
The Signature Singapore 486066
Tel: +65-6375-8560
Email: fcals@fcl-components.com

China

FCL COMPONENTS (SHANGHAI) CO.,LTD.
Unit 1105, Central Park - Jing An,
No.329 Heng Feng Road, Shanghai
200070, China
Tel: +86-21-3253 0998
Email: fcsh@fcl-components.com

Hong Kong

FCL COMPONENTS HONG KONG CO.,
LIMITED
Unit 2313, Seapower Tower, Concordia
Plaza, No.1 Science Museum Road,
TST, Kowloon, Hong Kong
Tel: +852-2881-8495
Email: fcals@fcl-components.com

Web: www.fcl-components.com/en/

© 2026 FCL Components Limited. All rights reserved. All trademarks or registered trademarks are the property of their respective owners.

FCL Components Products are intended for general use, including without limitation, in personal, household and office environments, in buildings and for ordinary use in the industry. FCL Components Products are not intended to be used in applications where extremely high safety is required ("High Safety Required Applications"), such as, but not limited to, applications in nuclear facilities, in aircraft automatic flight control, in air traffic control, in mass transit system control, in missile launch system, in weapon systems, in medical equipment for life support or any application involving a direct serious risk of physical injury or death.

Please do not use FCL Components Products without securing the sufficient safety and reliability required for the High Safety Required Applications.

In addition, FCL Components shall not be liable against the customer and/or any third party for any claims or damages arising in connection with the use of FCL Components Products in the High Safety Required Applications.

FCL Components warrants that its Products, if properly used and services, will conform to their specification and will be free from defects in material and workmanship for twelve months from delivery.

The implied warranties of merchantability and fitness for a particular purpose and all other warranties, representations and conditions, express or implied by statute, trade usage or otherwise, except as set forth in this warranty, are excluded and shall not apply to the Products delivered.

The contents, data and information in this datasheet are provided by FCL Components Limited as a service only to its user and only for general information purposes. The use of the contents, data and information provided in this datasheet is at the users' own risk.

FCL Components has assembled this datasheet with care and will endeavor to keep the contents, data and information correct, accurate, comprehensive, complete and up to date.

FCL Components Limited and affiliated companies do however not accept any responsibility or liability on their behalf, nor on behalf of its employees, for any loss or damage, direct, indirect or consequential, with respect to this datasheet, its contents, data, and information and related graphics and the correctness, reliability, accuracy, comprehensiveness, usefulness, availability and completeness thereof. Nor do FCL Components Limited and affiliated companies accept on their behalf, nor on behalf of its employees, any responsibility or liability with respect to these datasheets, its contents, data, information and related graphics and the correctness, reliability, accuracy, comprehensiveness, usefulness, availability and completeness thereof. Rev. March 26, 2026.