

## DS90C401 Dual Low Voltage Differential Signaling (LVDS) Driver

Check for Samples: [DS90C401](#)

### FEATURES

- Ultra Low Power Dissipation
- Operates Above 155.5 Mbps
- Standard TIA/EIA-644
- 8 Lead SOIC Package Saves Space
- Low Differential Output Swing typical 340 mV

### DESCRIPTION

The DS90C401 is a dual driver device optimized for high data rate and low power applications. This device along with the DS90C402 provides a pair chip solution for a dual high speed point-to-point interface. The DS90C401 is a current mode driver allowing power dissipation to remain low even at high frequency. In addition, the short circuit fault current is also minimized. The device is in a 8 lead small outline package. The differential driver outputs provides low EMI with its low output swings typically 340 mV.

### Connection Diagram

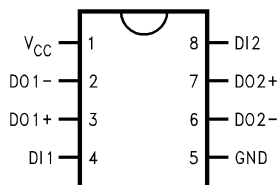

See Package Number D (SOIC)

### Functional Diagram

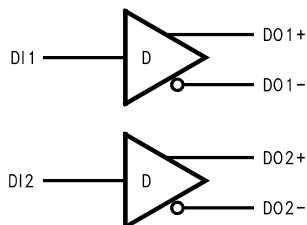

These devices have limited built-in ESD protection. The leads should be shorted together or the device placed in conductive foam during storage or handling to prevent electrostatic damage to the MOS gates.



Please be aware that an important notice concerning availability, standard warranty, and use in critical applications of Texas Instruments semiconductor products and disclaimers thereto appears at the end of this data sheet.

All trademarks are the property of their respective owners.

PRODUCTION DATA information is current as of publication date. Products conform to specifications per the terms of the Texas Instruments standard warranty. Production processing does not necessarily include testing of all parameters.

Copyright © 1998–2013, Texas Instruments Incorporated

### Absolute Maximum Ratings<sup>(1)(2)</sup>

Supply Voltage ( $V_{CC}$ )		-0.3V to +6V
Input Voltage ( $D_{IN}$ )		-0.3V to ( $V_{CC} + 0.3V$ )
Output Voltage ( $D_{OUT+}$ , $D_{OUT-}$ )		-0.3V to ( $V_{CC} + 0.3V$ )
Short Circuit Duration ( $D_{OUT+}$ , $D_{OUT-}$ )		Continuous
Maximum Package Power Dissipation @ +25°C	D Package	1068 mW
	Derate D Package	8.5 mW/°C above +25°C
Storage Temperature Range		-65°C to +150°C
Lead Temperature Range Soldering (4 sec.)		+260°C
Maximum Junction Temperature		+150°C
ESD Rating <sup>(3)</sup>	(HBM, 1.5 k $\Omega$ , 100 pF)	$\geq 3,500V$
	(EIAJ, 0 $\Omega$ , 200 pF)	$\geq 250V$

- (1) "Absolute Maximum Ratings" are those values beyond which the safety of the device cannot be ensured. They are not meant to imply that the devices should be operated at these limits. [Electrical Characteristics](#) specifies conditions of device operation.
- (2) If Military/Aerospace specified devices are required, please contact the Texas Instruments Sales Office/Distributors for availability and specifications.
- (3) ESD Ratings:  
HBM (1.5 k $\Omega$ , 100 pF)  $\geq 3,500V$   
EIAJ (0 $\Omega$ , 200 pF)  $\geq 250V$

### Recommended Operating Conditions

	Min	Typ	Max	Units
Supply Voltage ( $V_{CC}$ )	+4.5	+5.0	+5.5	V
Operating Free Air Temperature ( $T_A$ )	-40	+25	+85	°C

### Electrical Characteristics

Over supply voltage and operating temperature ranges, unless otherwise specified.<sup>(1)(2)</sup>

Symbol	Parameter	Conditions	Pin	Min	Typ	Max	Units
$V_{OD1}$	Differential Output Voltage	$R_L = 100\Omega$ (Figure 1)	$D_{OUT-}$ , $D_{OUT+}$	250	340	450	mV
$\Delta V_{OD1}$	Change in Magnitude of $V_{OD1}$ for Complementary Output States				4	35	mV
$V_{OS}$	Offset Voltage			1.125	1.25	1.375	V
$\Delta V_{OS}$	Change in Magnitude of $V_{OS}$ for Complementary Output States				5	25	mV
$V_{OH}$	Output Voltage High	$R_L = 100\Omega$			1.41	1.60	V
$V_{OL}$	Output Voltage Low			0.90	1.07		V
$I_{OS}$	Output Short Circuit Current	$V_{OUT} = 0V^{(3)}$			-3.5	-5.0	mA
$V_{IH}$	Input Voltage High		$D_{IN}$	2.0		$V_{CC}$	V
$V_{IL}$	Input Voltage Low				GND		0.8
$I_I$	Input Current	$V_{IN} = V_{CC}$ , GND, 2.5V or 0.4V		-10	$\pm 1$	+10	$\mu A$
$V_{CL}$	Input Clamp Voltage	$I_{CL} = -18$ mA		-1.5	-0.8		V
$I_{CC}$	No Load Supply Current	$D_{IN} = V_{CC}$ or GND	$V_{CC}$		1.7	3.0	mA
		$D_{IN} = 2.5V$ or 0.4V			3.5	5.5	mA
$I_{CCL}$	Loaded Supply Current	$R_L = 100\Omega$ All Channels $V_{IN} = V_{CC}$ or GND (all inputs)			8	14.0	mA

- (1) Current into device pins is defined as positive. Current out of device pins is defined as negative. All voltages are referenced to ground except:  $V_{OD1}$  and  $\Delta V_{OD1}$ .
- (2) All typicals are given for:  $V_{CC} = +5.0V$ ,  $T_A = +25^\circ C$ .
- (3) Output short circuit current ( $I_{OS}$ ) is specified as magnitude only, minus sign indicates direction only.

### Switching Characteristics

$V_{CC} = +5.0V \pm 10\%$ ,  $T_A = -40^\circ C$  to  $+85^\circ C$  (1)(2)(3)(4)(5)

Symbol	Parameter	Conditions	Min	Typ	Max	Units
$t_{PHLD}$	Differential Propagation Delay High to Low	$R_L = 100\Omega$ , $C_L = 5\text{ pF}$ (Figure 2 and Figure 3)	0.5	2.0	3.5	ns
$t_{PLHD}$	Differential Propagation Delay Low to High		0.5	2.1	3.5	ns
$t_{SKD}$	Differential Skew $ t_{PHLD} - t_{PLHD} $		0	80	900	ps
$t_{SK1}$	Channel-to-Channel Skew (2)		0	0.3	1.0	ns
$t_{SK2}$	Chip to Chip Skew (3)				3.0	ns
$t_{TLH}$	Rise Time			0.35	2.0	ns
$t_{THL}$	Fall Time			0.35	2.0	ns

- (1) All typicals are given for:  $V_{CC} = +5.0V$ ,  $T_A = +25^\circ C$ .
- (2) Channel-to-Channel Skew is defined as the difference between the propagation delay of the channel and the other channels in the same chip with an event on the inputs.
- (3) Chip to Chip Skew is defined as the difference between the minimum and maximum specified differential propagation delays.
- (4) Generator waveform for all tests unless otherwise specified:  $f = 1\text{ MHz}$ ,  $Z_O = 50\Omega$ ,  $t_r \leq 6\text{ ns}$ , and  $t_f \leq 6\text{ ns}$ .
- (5)  $C_L$  includes probe and jig capacitance.

### Parameter Measurement Information

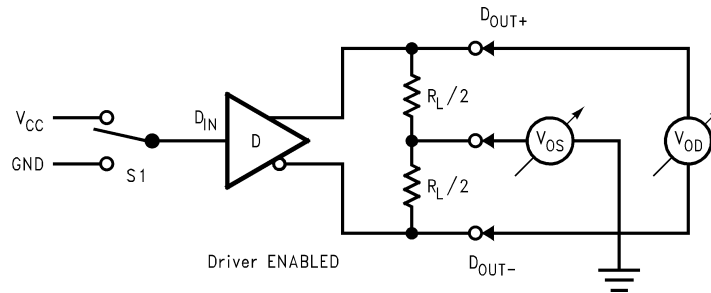

Figure 1. Driver  $V_{OD}$  and  $V_{OS}$  Test Circuit

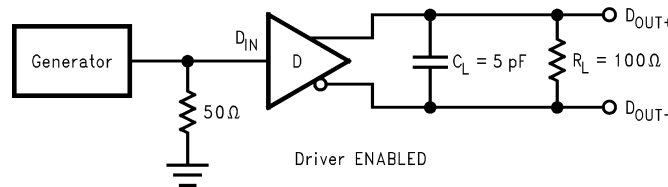
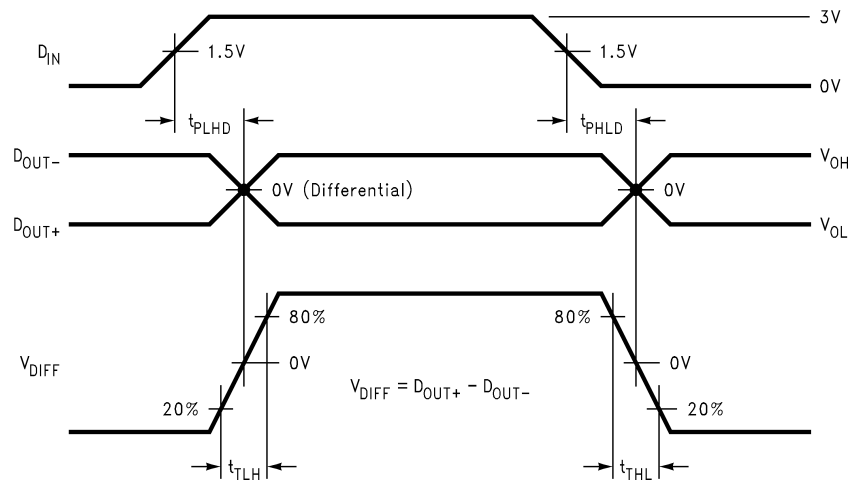

Figure 2. Driver Propagation Delay and Transition Time Test Circuit



**Figure 3. Driver Propagation Delay and Transition Time Waveforms**

TYPICAL APPLICATION

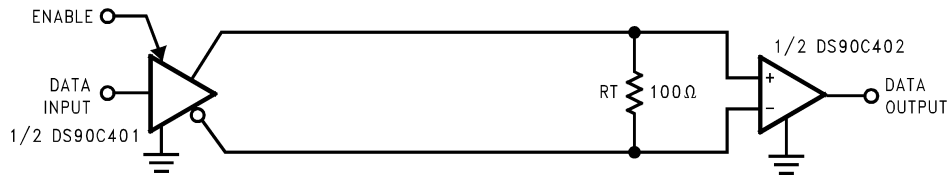

Figure 4. Point-to-Point Application

Applications Information

LVDS drivers and receivers are intended to be primarily used in an uncomplicated point-to-point configuration as is shown in Figure 4. This configuration provides a clean signaling environment for the quick edge rates of the drivers. The receiver is connected to the driver through a balanced media which may be a standard twisted pair cable, a parallel pair cable, or simply PCB traces. Typically, the characteristic impedance of the media is in the range of 100Ω. A termination resistor of 100Ω should be selected to match the media, and is located as close to the receiver input pins as possible. The termination resistor converts the current sourced by the driver into a voltage that is detected by the receiver. Other configurations are possible such as a multi-receiver configuration, but the effects of a mid-stream connector(s), cable stub(s), and other impedance discontinuities as well as ground shifting, noise margin limits, and total termination loading must be taken into account.

The DS90C401 differential line driver is a balanced current source design. A current mode driver, generally speaking has a high output impedance and supplies a constant current for a range of loads (a voltage mode driver on the other hand supplies a constant voltage for a range of loads). Current is switched through the load in one direction to produce a logic state and in the other direction to produce the other logic state. The typical output current is mere 3.4 mA, a minimum of 2.5 mA, and a maximum of 4.5 mA. The current mode **requires** (as discussed above) that a resistive termination be employed to terminate the signal and to complete the loop as shown in Figure 4. AC or unterminated configurations are not allowed. The 3.4 mA loop current will develop a differential voltage of 340 mV across the 100Ω termination resistor which the receiver detects with a 240 mV minimum differential noise margin neglecting resistive line losses (driven signal minus receiver threshold (340 mV – 100 mV = 240 mV)). The signal is centered around +1.2V (Driver Offset,  $V_{OS}$ ) with respect to ground as shown in Figure 5. Note that the steady-state voltage ( $V_{SS}$ ) peak-to-peak swing is twice the differential voltage ( $V_{OD}$ ) and is typically 680 mV.

The current mode driver provides substantial benefits over voltage mode drivers, such as an RS-422 driver. Its quiescent current remains relatively flat versus switching frequency. Whereas the RS-422 voltage mode driver increases exponentially in most case between 20 MHz–50 MHz. This is due to the overlap current that flows between the rails of the device when the internal gates switch. Whereas the current mode driver switches a fixed current between its output without any substantial overlap current. This is similar to some ECL and PECL devices, but without the heavy static  $I_{CC}$  requirements of the ECL/PECL designs. LVDS requires > 80% less current than similar PECL devices. AC specifications for the driver are a tenfold improvement over other existing RS-422 drivers.

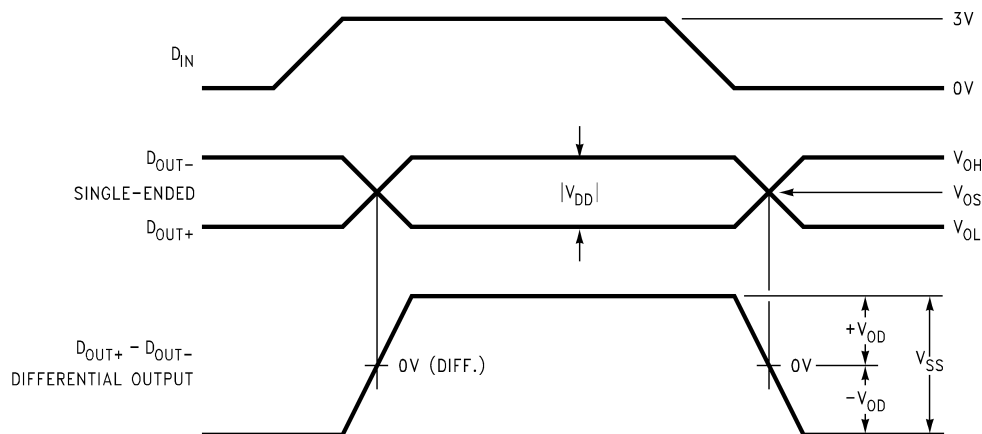

Figure 5. Driver Output Levels

**PIN DESCRIPTIONS**

Pin No.	Name	Description
4, 8	D <sub>IN</sub>	TTL/CMOS driver input pins
3, 7	D <sub>OUT+</sub>	Non-inverting driver output pin
2, 6	D <sub>OUT-</sub>	Inverting driver output pin
5	GND	Ground pin
1	V <sub>CC</sub>	Positive power supply pin, +5.0V ± 10%

**Truth Table<sup>(1)</sup>**

D <sub>IN</sub>	D <sub>OUT+</sub>	D <sub>OUT-</sub>
L	L	H
H	H	L
D <sub>IN</sub> > 0.8V and D <sub>IN</sub> < 2.0V	X	X

- (1) H = Logic high level  
 L = Logic low level  
 X = Indeterminant state

Typical Performance Characteristics

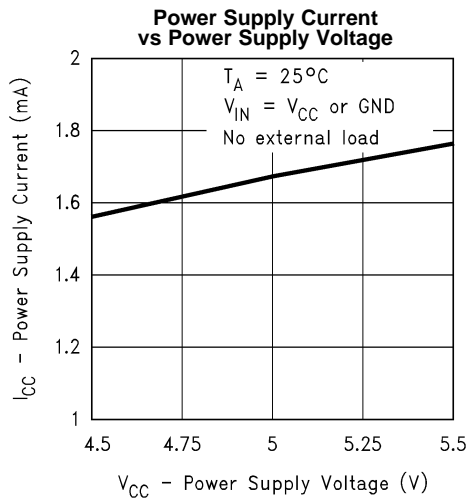

Figure 6.

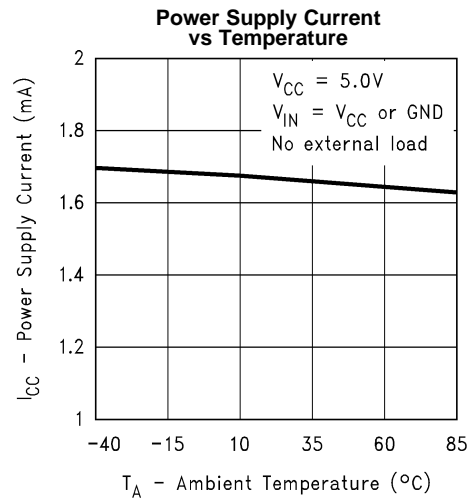

Figure 7.

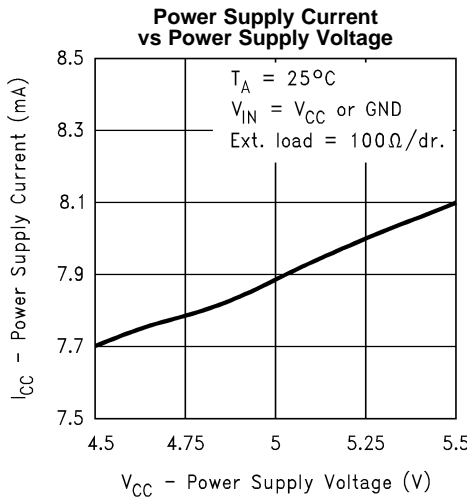

Figure 8.

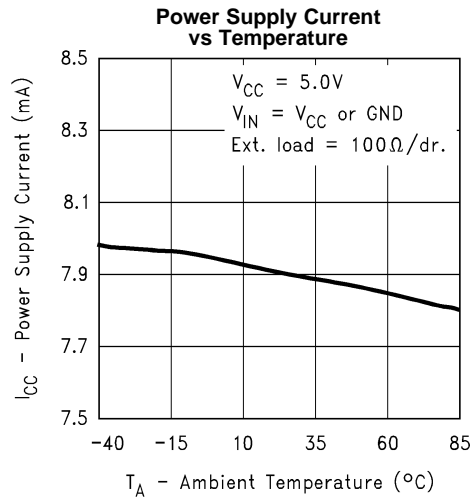

Figure 9.

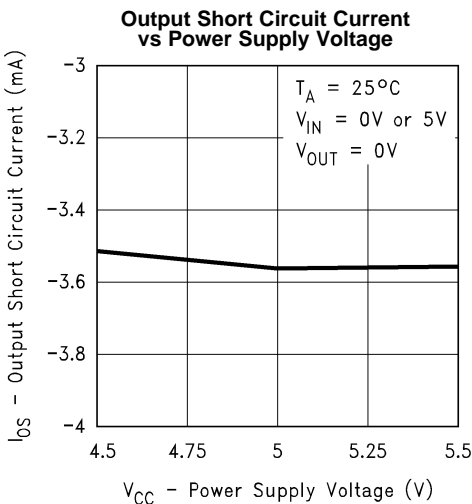

Figure 10.

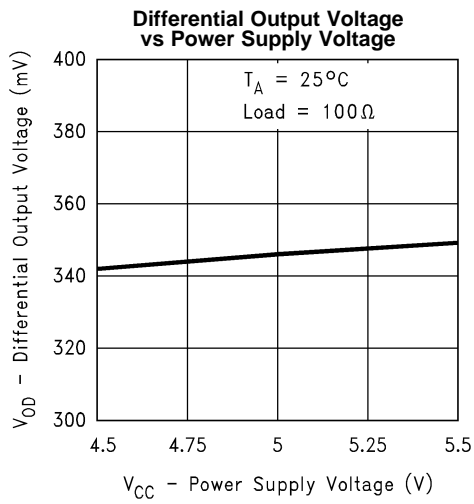

Figure 11.

### Typical Performance Characteristics (continued)

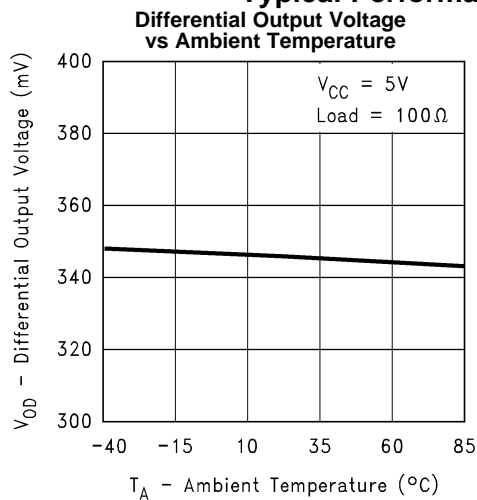

Figure 12.

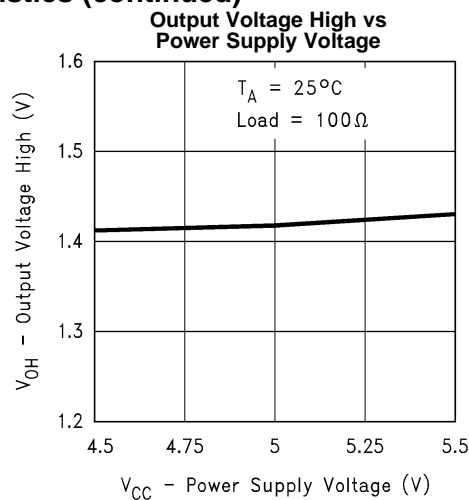

Figure 13.

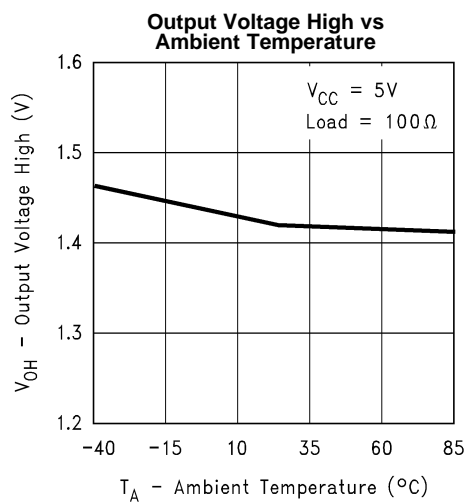

Figure 14.

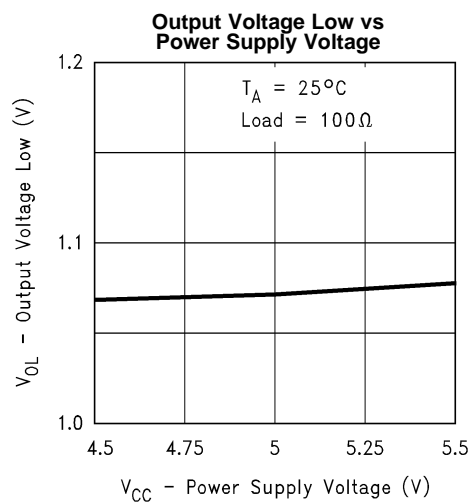

Figure 15.

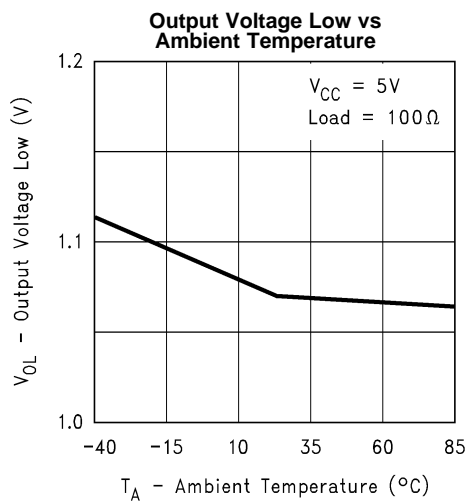

Figure 16.

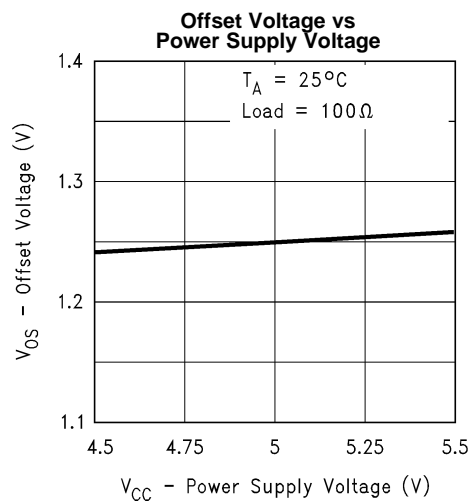

Figure 17.



Typical Performance Characteristics (continued)

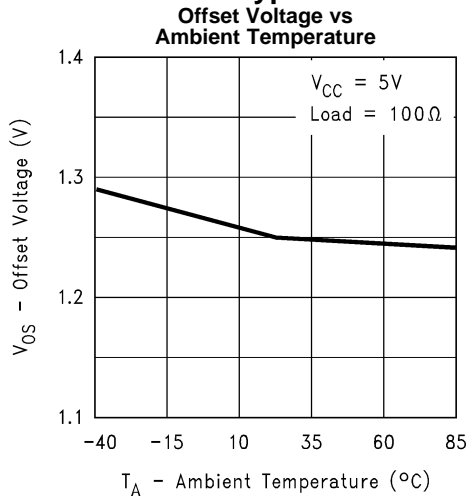

Figure 18.

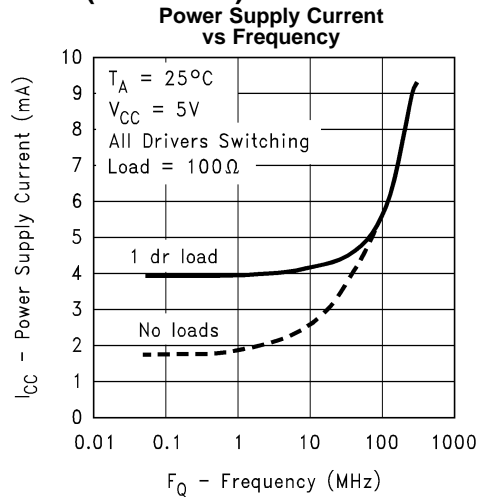

Figure 19.

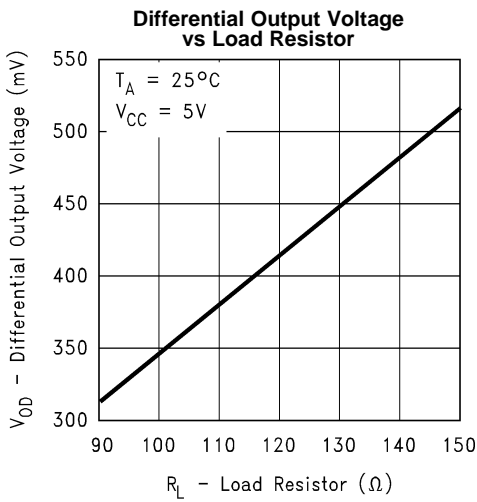

Figure 20.

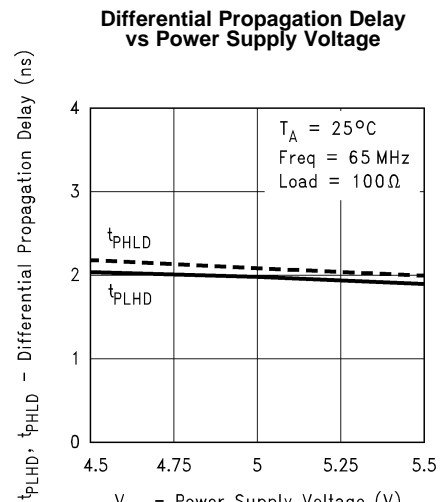

Figure 21.

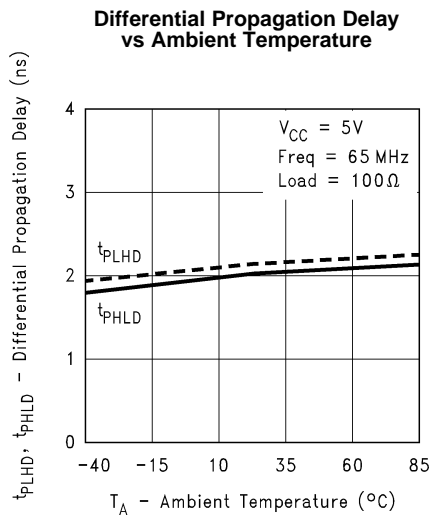

Figure 22.

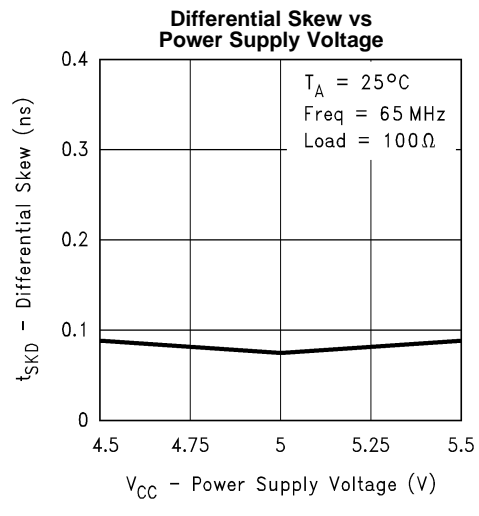

Figure 23.

**Typical Performance Characteristics (continued)**

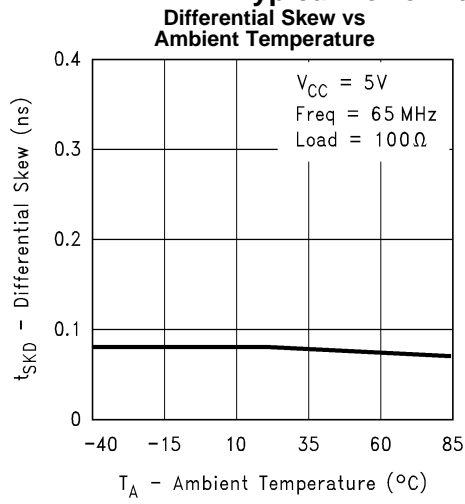

Figure 24.

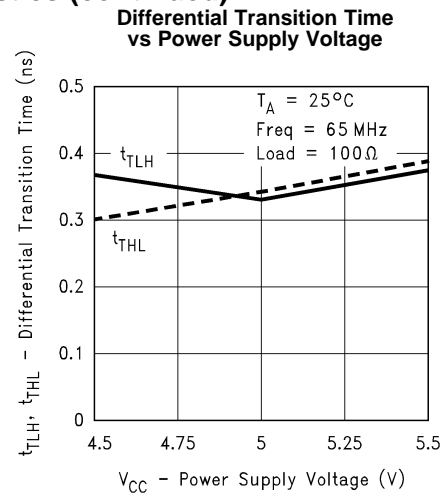

Figure 25.

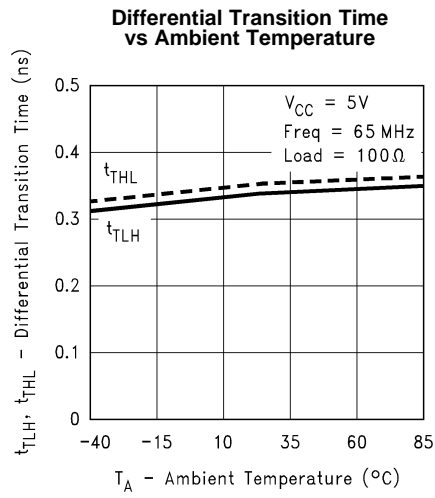

Figure 26.



---

**REVISION HISTORY**

<b>Changes from Revision B (April 2013) to Revision C</b>	<b>Page</b>
• Changed layout of National Data Sheet to TI format .....	<a href="#">9</a>

---

**PACKAGING INFORMATION**

Orderable Device	Status (1)	Package Type	Package Drawing	Pins	Package Qty	Eco Plan (2)	Lead finish/ Ball material (6)	MSL Peak Temp (3)	Op Temp (°C)	Device Marking (4/5)	Samples
DS90C401M	NRND	SOIC	D	8	95	Non-RoHS & Green	Call TI	Level-1-235C-UNLIM		DS90C401M	
DS90C401M/NOPB	ACTIVE	SOIC	D	8	95	RoHS & Green	SN	Level-1-260C-UNLIM	-40 to 85	DS90C401M	
DS90C401MX/NOPB	ACTIVE	SOIC	D	8	2500	RoHS & Green	SN	Level-1-260C-UNLIM	-40 to 85	DS90C401M	

(1) The marketing status values are defined as follows:

**ACTIVE:** Product device recommended for new designs.

**LIFEBUY:** TI has announced that the device will be discontinued, and a lifetime-buy period is in effect.

**NRND:** Not recommended for new designs. Device is in production to support existing customers, but TI does not recommend using this part in a new design.

**PREVIEW:** Device has been announced but is not in production. Samples may or may not be available.

**OBSELETE:** TI has discontinued the production of the device.

(2) **RoHS:** TI defines "RoHS" to mean semiconductor products that are compliant with the current EU RoHS requirements for all 10 RoHS substances, including the requirement that RoHS substance do not exceed 0.1% by weight in homogeneous materials. Where designed to be soldered at high temperatures, "RoHS" products are suitable for use in specified lead-free processes. TI may reference these types of products as "Pb-Free".

**RoHS Exempt:** TI defines "RoHS Exempt" to mean products that contain lead but are compliant with EU RoHS pursuant to a specific EU RoHS exemption.

**Green:** TI defines "Green" to mean the content of Chlorine (Cl) and Bromine (Br) based flame retardants meet JS709B low halogen requirements of <=1000ppm threshold. Antimony trioxide based flame retardants must also meet the <=1000ppm threshold requirement.

(3) MSL, Peak Temp. - The Moisture Sensitivity Level rating according to the JEDEC industry standard classifications, and peak solder temperature.

(4) There may be additional marking, which relates to the logo, the lot trace code information, or the environmental category on the device.

(5) Multiple Device Markings will be inside parentheses. Only one Device Marking contained in parentheses and separated by a "~" will appear on a device. If a line is indented then it is a continuation of the previous line and the two combined represent the entire Device Marking for that device.

(6) Lead finish/Ball material - Orderable Devices may have multiple material finish options. Finish options are separated by a vertical ruled line. Lead finish/Ball material values may wrap to two lines if the finish value exceeds the maximum column width.

**Important Information and Disclaimer:**The information provided on this page represents TI's knowledge and belief as of the date that it is provided. TI bases its knowledge and belief on information provided by third parties, and makes no representation or warranty as to the accuracy of such information. Efforts are underway to better integrate information from third parties. TI has taken and continues to take reasonable steps to provide representative and accurate information but may not have conducted destructive testing or chemical analysis on incoming materials and chemicals. TI and TI suppliers consider certain information to be proprietary, and thus CAS numbers and other limited information may not be available for release.

In no event shall TI's liability arising out of such information exceed the total purchase price of the TI part(s) at issue in this document sold by TI to Customer on an annual basis.

**TAPE AND REEL INFORMATION**

**QUADRANT ASSIGNMENTS FOR PIN 1 ORIENTATION IN TAPE**

\*All dimensions are nominal

Device	Package Type	Package Drawing	Pins	SPQ	Reel Diameter (mm)	Reel Width W1 (mm)	A0 (mm)	B0 (mm)	K0 (mm)	P1 (mm)	W (mm)	Pin1 Quadrant
DS90C401MX/NOPB	SOIC	D	8	2500	330.0	12.4	6.5	5.4	2.0	8.0	12.0	Q1

**TAPE AND REEL BOX DIMENSIONS**



\*All dimensions are nominal

Device	Package Type	Package Drawing	Pins	SPQ	Length (mm)	Width (mm)	Height (mm)
DS90C401MX/NOPB	SOIC	D	8	2500	367.0	367.0	35.0

**TUBE**

\*All dimensions are nominal

Device	Package Name	Package Type	Pins	SPQ	L (mm)	W (mm)	T (μm)	B (mm)
DS90C401M	D	SOIC	8	95	495	8	4064	3.05
DS90C401M	D	SOIC	8	95	495	8	4064	3.05
DS90C401M/NOPB	D	SOIC	8	95	495	8	4064	3.05



# D0008A



## PACKAGE OUTLINE

SOIC - 1.75 mm max height

SMALL OUTLINE INTEGRATED CIRCUIT

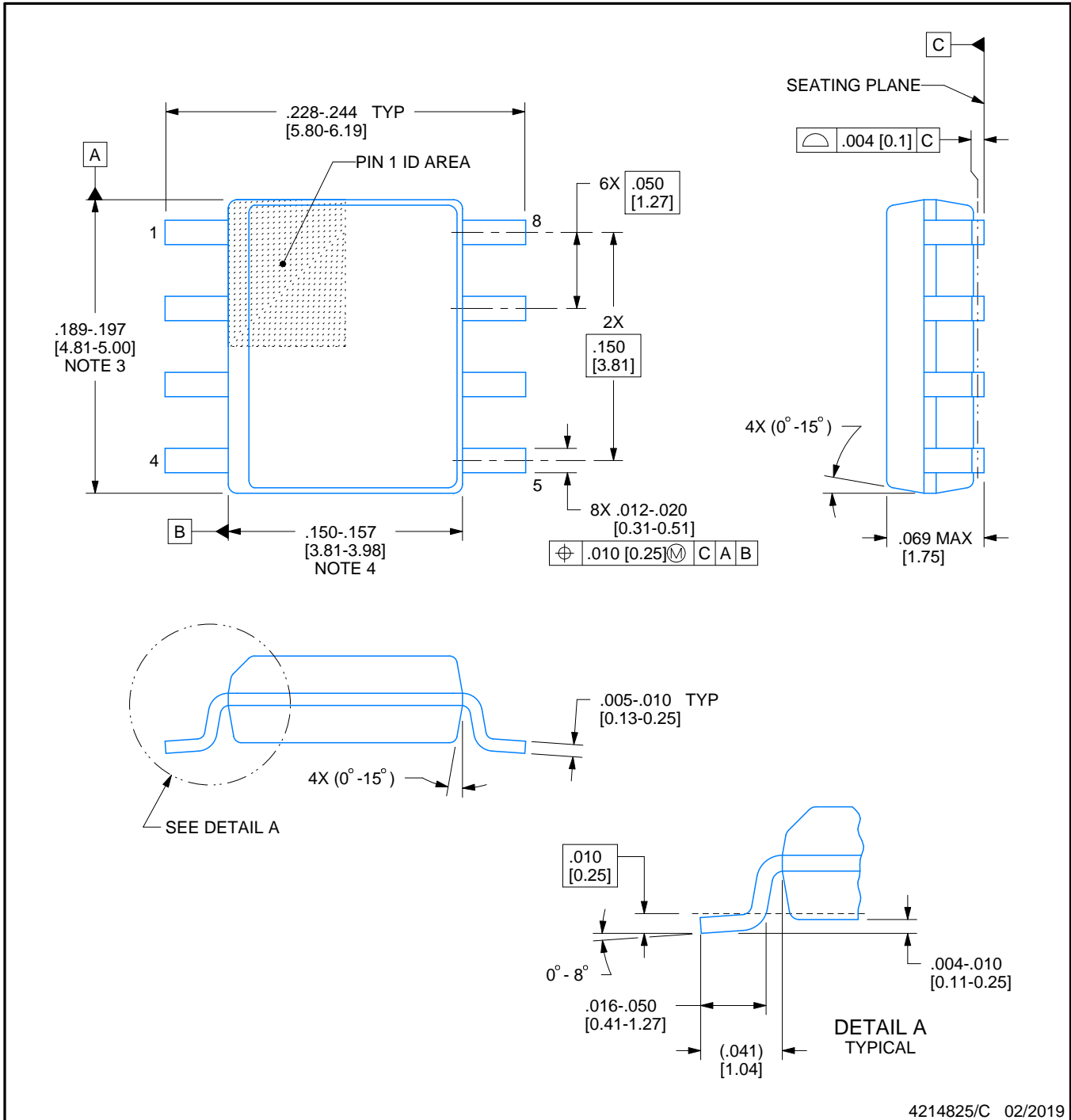

4214825/C 02/2019

### NOTES:

- Linear dimensions are in inches [millimeters]. Dimensions in parenthesis are for reference only. Controlling dimensions are in inches. Dimensioning and tolerancing per ASME Y14.5M.
- This drawing is subject to change without notice.
- This dimension does not include mold flash, protrusions, or gate burrs. Mold flash, protrusions, or gate burrs shall not exceed  $.006$  [0.15] per side.
- This dimension does not include interlead flash.
- Reference JEDEC registration MS-012, variation AA.

# EXAMPLE BOARD LAYOUT

D0008A

SOIC - 1.75 mm max height

SMALL OUTLINE INTEGRATED CIRCUIT



LAND PATTERN EXAMPLE  
EXPOSED METAL SHOWN  
SCALE:8X



SOLDER MASK DETAILS

4214825/C 02/2019

NOTES: (continued)

6. Publication IPC-7351 may have alternate designs.

7. Solder mask tolerances between and around signal pads can vary based on board fabrication site.

# EXAMPLE STENCIL DESIGN

D0008A

SOIC - 1.75 mm max height

SMALL OUTLINE INTEGRATED CIRCUIT



SOLDER PASTE EXAMPLE  
BASED ON .005 INCH [0.125 MM] THICK STENCIL  
SCALE:8X

4214825/C 02/2019

NOTES: (continued)

8. Laser cutting apertures with trapezoidal walls and rounded corners may offer better paste release. IPC-7525 may have alternate design recommendations.
9. Board assembly site may have different recommendations for stencil design.

## IMPORTANT NOTICE AND DISCLAIMER

TI PROVIDES TECHNICAL AND RELIABILITY DATA (INCLUDING DATA SHEETS), DESIGN RESOURCES (INCLUDING REFERENCE DESIGNS), APPLICATION OR OTHER DESIGN ADVICE, WEB TOOLS, SAFETY INFORMATION, AND OTHER RESOURCES "AS IS" AND WITH ALL FAULTS, AND DISCLAIMS ALL WARRANTIES, EXPRESS AND IMPLIED, INCLUDING WITHOUT LIMITATION ANY IMPLIED WARRANTIES OF MERCHANTABILITY, FITNESS FOR A PARTICULAR PURPOSE OR NON-INFRINGEMENT OF THIRD PARTY INTELLECTUAL PROPERTY RIGHTS.

These resources are intended for skilled developers designing with TI products. You are solely responsible for (1) selecting the appropriate TI products for your application, (2) designing, validating and testing your application, and (3) ensuring your application meets applicable standards, and any other safety, security, regulatory or other requirements.

These resources are subject to change without notice. TI grants you permission to use these resources only for development of an application that uses the TI products described in the resource. Other reproduction and display of these resources is prohibited. No license is granted to any other TI intellectual property right or to any third party intellectual property right. TI disclaims responsibility for, and you will fully indemnify TI and its representatives against, any claims, damages, costs, losses, and liabilities arising out of your use of these resources.

TI's products are provided subject to [TI's Terms of Sale](#) or other applicable terms available either on [ti.com](http://ti.com) or provided in conjunction with such TI products. TI's provision of these resources does not expand or otherwise alter TI's applicable warranties or warranty disclaimers for TI products.

TI objects to and rejects any additional or different terms you may have proposed.

Mailing Address: Texas Instruments, Post Office Box 655303, Dallas, Texas 75265  
Copyright © 2022, Texas Instruments Incorporated