

## Data Sheet | Item Number: 254-842

Stackable PCB terminal block; 2.5 mm<sup>2</sup>; Pin spacing 5/5.08 mm; 1-pole; PUSH WIRE®; dark gray

<https://www.wago.com/254-842>



Color: ■ dark gray

Similar to illustration

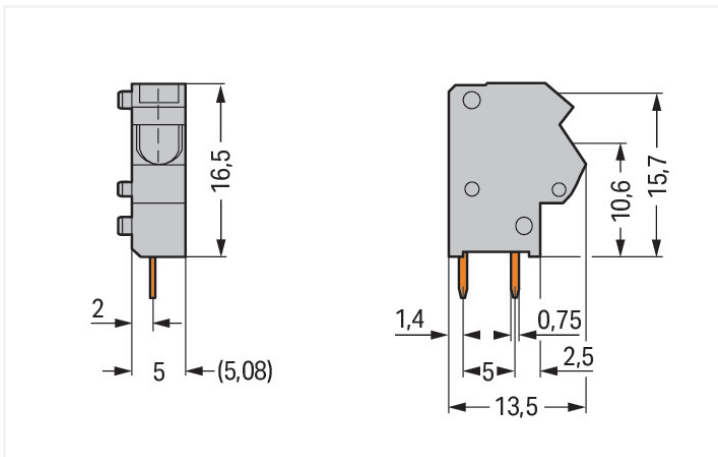
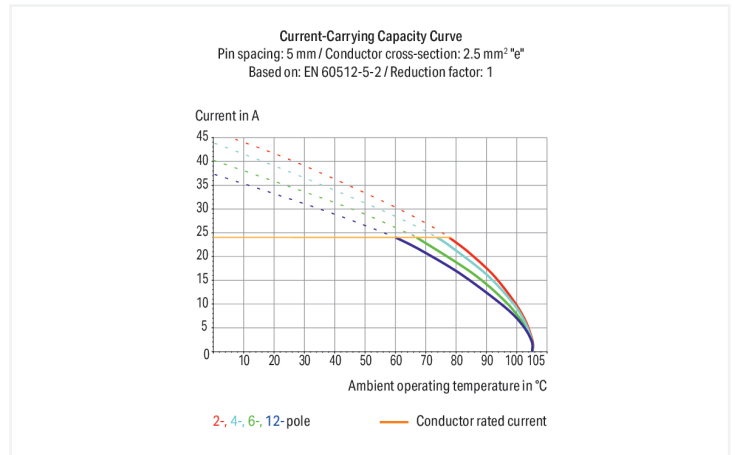

Dimensions in mm

### PCB terminal block, 254 Series, with 5 mm pin spacing

Our PCB terminal block (item number 254-842) is designed for seamless electrical installations. It offers the flexibility needed for different mounting types. Ensure that the strip lengths are between 10 and 12 mm when connecting conductors to this PCB terminal block. This product features one conductor terminal and utilizes PUSH WIRE®. Our trusted PUSH WIRE® connection offers the fastest method for clamping conductors. It utilizes the conductor's stiffness to overcome the clamping spring's contact force. The item's dimensions are (6.7 x 19.7 x 13.5) mm (width x height x depth). This PCB terminal block is suitable for conductor cross sections ranging from 0.5 mm<sup>2</sup> to 2.5 mm<sup>2</sup>.

The contact surface is coated with tin. This PCB terminal block is operated with an operating tool. THT is used to assemble the PCB terminal block. The conductor is designed to be inserted into the board at a 45° angle.

## Notes

Variants:

Other colors

Other versions (or variants) can be requested from WAGO Sales or configured at <https://configurator.wago.com/>.

## Electrical data

Ratings per	IEC/EN 60664-1		
Overvoltage category	III	III	II
Pollution degree	3	2	2
Nominal voltage	320 V	320 V	630 V
Rated impulse withstand voltage	4 kV	4 kV	4 kV
Rated current	24 A	24 A	24 A

Approvals per	UL 1059		
Use group	B	C	D
Rated voltage	300 V	-	300 V
Rated current	10 A	-	10 A

Approvals per	CSA		
Use group	B	C	D
Rated voltage	300 V	-	300 V
Rated current	10 A	-	10 A

## Connection Data

Clamping units	1
Total number of potentials	1
Number of connection types	1
Number of levels	1

Connection 1	
Connection technology	PUSH WIRE®
Actuation type	Operating tool
Solid conductor	0.5 ... 2.5 mm <sup>2</sup> / 20 ... 12 AWG
Fine-stranded conductor; with insulated ferrule	0.5 ... 1.5 mm <sup>2</sup>
Fine-stranded conductor; with uninsulated ferrule	0.5 ... 1.5 mm <sup>2</sup>
Note (conductor cross-section)	12 AWG: THHN, THWN
Strip length	10 ... 12 mm / 0.39 ... 0.47 inches
Conductor connection direction to PCB	45 °
Pole number	1

## Physical data

Pin spacing	5/5.08 mm / 0.197/0.2 inches
Width	6.7 mm / 0.264 inches
Height	19.7 mm / 0.776 inches
Height from the surface	15.7 mm / 0.618 inches
Depth	13.5 mm / 0.531 inches
Solder pin length	4 mm
Solder pin dimensions	0.5 x 0.75 mm
Drilled hole diameter with tolerance	1.1 (+0.1) mm

### PCB contact

PCB contact	THT
Solder pin arrangement	within the terminal block (in-line)
Number of solder pins per potential	2

### Material data

Note (material data)	<a href="#">Information on material specifications can be found here</a>
Color	dark gray
Material group	I
Insulation material (main housing)	Polyamide (PA66)
Flammability class per UL94	V0
Clamping spring material	Chrome-nickel spring steel (CrNi)
Contact material	Electrolytic copper (E <sub>cu</sub> )
Contact Plating	Tin
Fire load	0.016 MJ
Weight	1.1 g

### Environmental requirements

Limit temperature range	-60 ... +105 °C
-------------------------	-----------------

### Commercial data

Product Group	4 (Printed Circuit Connectors)
PU (SPU)	500 (100) pcs
Packaging type	Box
Country of origin	PL
GTIN	4044918942201
Customs tariff number	85369010000

### Product Classification

UNSPSC	39121409
eCl@ss 10.0	27-44-04-01
eCl@ss 9.0	27-44-04-01
ETIM 9.0	EC002643
ETIM 10.0	EC002643
ECCN	NO US CLASSIFICATION

### Environmental Product Compliance

RoHS Compliance Status	Compliant, No Exemption
------------------------	-------------------------

### Approvals / Certificates

#### General approvals



#### General approvals

UR UL 1059 E45172  
Underwriters Laboratories  
Inc.

Approval	Standard	Certificate Name
CCA DEKRA Certification B.V.	EN 60947	NTR NL 7375
CSA DEKRA Certification B.V.	C22.2	70154033

Approvals for marine applications



Approval	Standard	Certificate Name
ABS American Bureau of Ship- ping	-	24-0095975-PDA
DNV DNV GL SE	-	TAE000016Z
PRS Polski Rejestr Statków	-	TE/1095/880590/23

Downloads

Environmental Product Compliance

Compliance Search
Environmental Product Compliance 254-842 <a href="#">↓</a>

Documentation

Additional Information			
Technical Section	03.04.2019	pdf 2027.26 KB	<a href="#">↓</a>

CAD/CAE-Data

CAD data
2D/3D Models 254-842 <a href="#">↓</a>

CAE data
EPLAN Data Portal 254-842 <a href="#">↓</a>
ZUKEN Portal 254-842 <a href="#">↓</a>

PCB Design

Symbol and Footprint via SamacSys 254-842 <a href="#">↓</a>
Symbol and Footprint via Ultra Librarian 254-842 <a href="#">↓</a>

## 1 Compatible Products

### 1.1 Required Accessories

#### 1.1.1 End plate

##### 1.1.1.1 End plate



**Item No.: 254-400**

End plate; 1 mm thick; snap-fit type; blue

**Item No.: 254-200**

End plate; 1 mm thick; snap-fit type; dark gray

**Item No.: 254-100**

End plate; 1 mm thick; snap-fit type; gray

**Item No.: 254-300**

End plate; 1 mm thick; snap-fit type; light gray



**Item No.: 254-700**

End plate; 1 mm thick; snap-fit type; light green

**Item No.: 254-600**

End plate; 1 mm thick; snap-fit type; orange

## 1.2 Optional Accessories

### 1.2.1 Ferrule

#### 1.2.1.1 Ferrule



**Item No.: 216-241**

Ferrule; Sleeve for 0.5 mm<sup>2</sup> / 20 AWG; insulated; electro-tin plated; electrolytic copper; gastight crimped; acc. to DIN 46228, Part 4/09.90; white

**Item No.: 216-141**

Ferrule; Sleeve for 0.5 mm<sup>2</sup> / 20 AWG; un-insulated; electro-tin plated; electrolytic copper; gastight crimped; acc. to DIN 46228, Part 1/08.92

**Item No.: 216-242**

Ferrule; Sleeve for 0.75 mm<sup>2</sup> / 18 AWG; insulated; electro-tin plated; electrolytic copper; gastight crimped; acc. to DIN 46228, Part 4/09.90; gray

**Item No.: 216-262**

Ferrule; Sleeve for 0.75 mm<sup>2</sup> / 18 AWG; un-insulated; electro-tin plated; electrolytic copper; gastight crimped; acc. to DIN 46228, Part 4/09.90; gray



**Item No.: 216-142**

Ferrule; Sleeve for 0.75 mm<sup>2</sup> / 18 AWG; un-insulated; electro-tin plated; electrolytic copper; gastight crimped; acc. to DIN 46228, Part 1/08.92

**Item No.: 216-243**

Ferrule; Sleeve for 1 mm<sup>2</sup> / AWG 18; insulated; electro-tin plated; electrolytic copper; gastight crimped; acc. to DIN 46228, Part 4/09.90; red

**Item No.: 216-263**

Ferrule; Sleeve for 1 mm<sup>2</sup> / AWG 18; un-insulated; electro-tin plated; electrolytic copper; gastight crimped; acc. to DIN 46228, Part 4/09.90; red

**Item No.: 216-143**

Ferrule; Sleeve for 1 mm<sup>2</sup> / AWG 18; un-insulated; electro-tin plated; electrolytic copper; gastight crimped; acc. to DIN 46228, Part 1/08.92



**Item No.: 216-244**

Ferrule; Sleeve for 1.5 mm<sup>2</sup> / AWG 16; un-insulated; electro-tin plated; electrolytic copper; gastight crimped; acc. to DIN 46228, Part 4/09.90; black

**Item No.: 216-264**

Ferrule; Sleeve for 1.5 mm<sup>2</sup> / AWG 16; un-insulated; electro-tin plated; electrolytic copper; gastight crimped; acc. to DIN 46228, Part 4/09.90; black

**Item No.: 216-144**

Ferrule; Sleeve for 1.5 mm<sup>2</sup> / AWG 16; un-insulated; electro-tin plated; electrolytic copper; gastight crimped; acc. to DIN 46228, Part 1/08.92; silver-colored

## 1.2.2 Marking

### 1.2.2.1 Marking strip



**Item No.: 210-332/500-202**

Marking strips; as a DIN A4 sheet; MARKED; 1-16 (160x); Height of marker strip: 3 mm; Strip length 182 mm; Horizontal marking; Self-adhesive; white

**Item No.: 210-332/508-202**

Marking strips; as a DIN A4 sheet; MARKED; 1-16 (160x); Height of marker strip: 3 mm; Strip length 182 mm; Horizontal marking; Self-adhesive; white

**Item No.: 210-332/500-205**

Marking strips; as a DIN A4 sheet; MARKED; 1-32 (80x); Height of marker strip: 3 mm; Strip length 182 mm; Horizontal marking; Self-adhesive; white

**Item No.: 210-332/508-205**

Marking strips; as a DIN A4 sheet; MARKED; 1-32 (80x); Height of marker strip: 3 mm; Strip length 182 mm; Horizontal marking; Self-adhesive; white



**Item No.: 210-332/500-204**

Marking strips; as a DIN A4 sheet; MARKED; 17-32 (160x); Height of marker strip: 3 mm; Strip length 182 mm; Horizontal marking; Self-adhesive; white

**Item No.: 210-332/508-204**

Marking strips; as a DIN A4 sheet; MARKED; 17-32 (160x); Height of marker strip: 3 mm; Strip length 182 mm; Horizontal marking; Self-adhesive; white

**Item No.: 210-332/500-206**

Marking strips; as a DIN A4 sheet; MARKED; 33-48 (160x); Height of marker strip: 3 mm; Strip length 182 mm; Horizontal marking; Self-adhesive; white

**Item No.: 210-332/508-206**

Marking strips; as a DIN A4 sheet; MARKED; 33-48 (160x); Height of marker strip: 3 mm; Strip length 182 mm; Horizontal marking; Self-adhesive; white

### 1.2.3 Test and measurement

#### 1.2.3.1 Testing accessories



**Item No.: 210-136**

Test plug; 2 mm Ø; with 500 mm cable; red

### 1.2.4 Tool

#### 1.2.4.1 Operating tool



**Item No.: 210-658**

Operating tool; Blade: 3.5 x 0.5 mm; with a partially insulated shaft; angled; short; multicoloured



**Item No.: 210-720**

Operating tool; Blade: 3.5 x 0.5 mm; with a partially insulated shaft; multicoloured



**Item No.: 210-657**

Operating tool; Blade: 3.5 x 0.5 mm; with a partially insulated shaft; short; multicoloured

### Installation Notes

#### Conductor termination

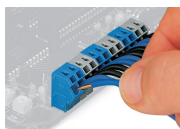

Insert solid conductors via push-in termination.

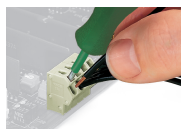

Inserting a tip-bonded conductor via screwdriver.

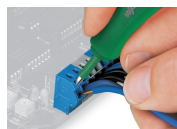

Removing a solid conductor.

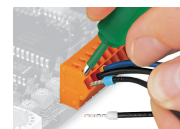

Inserting/removing a ferruled conductor.

### Marking

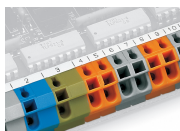

Labeling via self-adhesive marking strips.



Labeling via factory direct marking.

### Testing



Testing with 2 mm Ø test plug.

Application

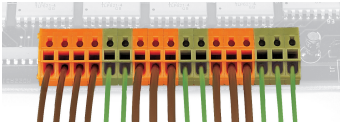

Mixed terminal strips can be assembled using different housing colors for the formation of groups.

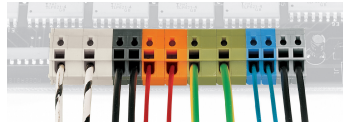

Mixed terminal strips can be assembled using different pin spacing and housing colors for the formation of groups.

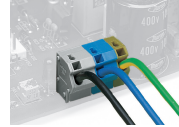

Application example: field-wiring terminal strip