

**Data Sheet | Item Number: 750-559/025-000**  
 4-channel analog output; 0 ... 10 VDC; Ext. Temperature

<https://www.wago.com/750-559/025-000>

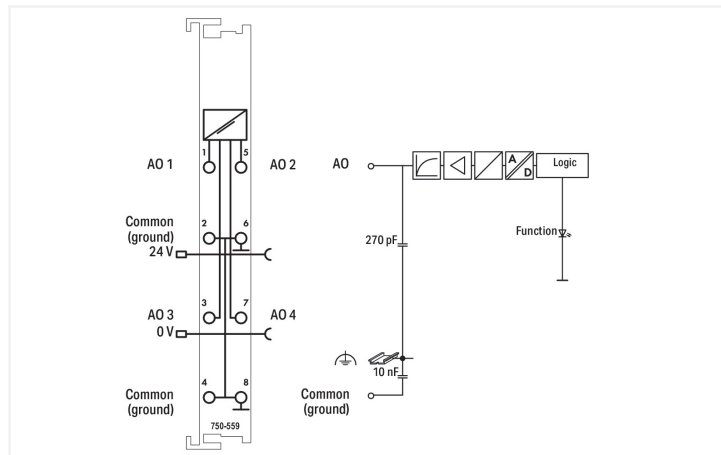

Color: ■ light gray

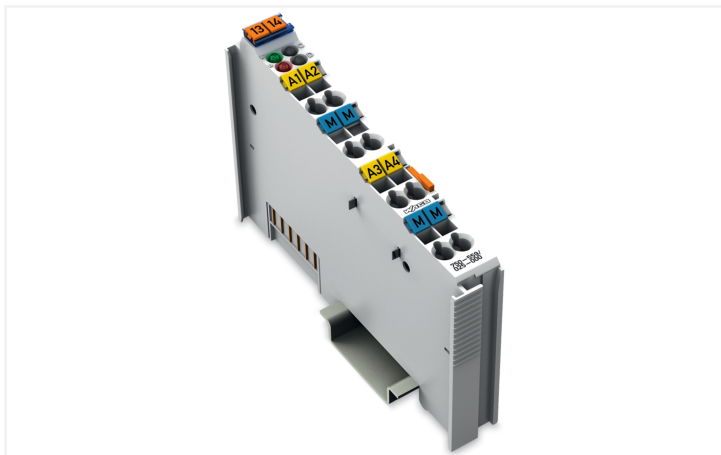
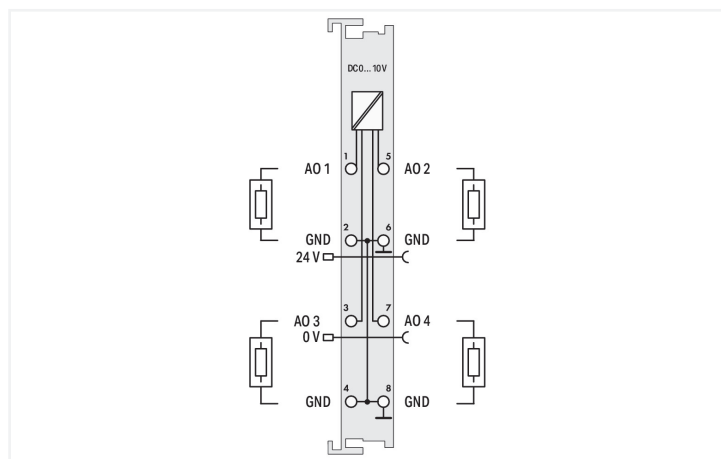
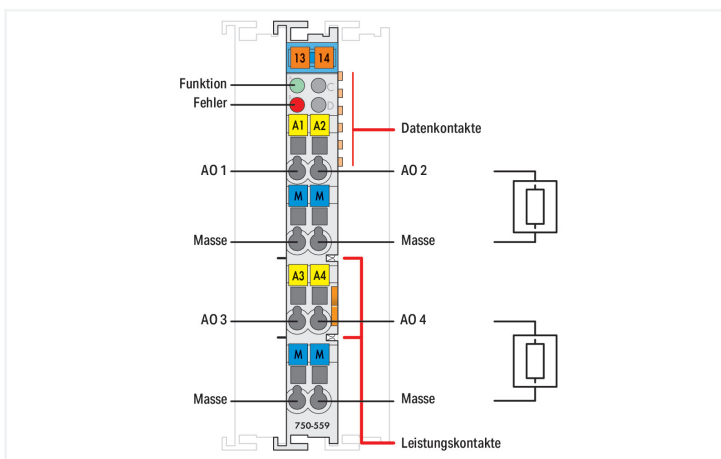

This analog output module generates standard 0–10 V signals.  
 The output signal is electrically isolated and transmitted with a resolution of 12 bits.  
 The internal system supply powers the module.  
 The module's output channels have a common ground potential.

**Technical data**

Number of analog outputs	4
Total number of channels (module)	4
Signal type	Voltage
Signal type (voltage)	0 ... 10 VDC
Actuator connection	4 x (2-wire)
Resolution [bit]	12 bits
Data width	4 x 16-bit data; 4 x 8-bit control/status (optional)
Load impedance (voltage output)	≥ 5 kΩ
Conversion time (typ.)	10 ms
Output error, reference temperature	25 °C
Output error, deviation (max.) of the upper-range value	0.1 %
Temperature error (max.) of the output range value	0.01 %/K
Recovery time (typ.)	100 ms
Supply voltage (system)	5 VDC; via data contacts

### Technical data

Current consumption (system supply)	125 mA
Supply voltage (field)	24 VDC (-25 ... +30 %); via power jumper contacts (power supply via blade contact; transmission (field side supply voltage only) via spring contact)
Isolation	500 V system/field
Indicators	LED (A) green: function; LED (B) red: Error
Number of incoming power jumper contacts	2
Number of outgoing power jumper contacts	2

### Connection Data

Connection technology: I/O	8 x CAGE CLAMP®
Connectable conductor materials	Copper
Connection type	Inputs/outputs
Solid conductor	0.08 ... 2.5 mm <sup>2</sup> / 28 ... 14 AWG
Fine-stranded conductor	0.08 ... 2.5 mm <sup>2</sup> / 28 ... 14 AWG
Strip length	8 ... 9 mm / 0.31 ... 0.35 inches

### Physical data

Width	12 mm / 0.472 inches
Height	100 mm / 3.937 inches
Depth	69.8 mm / 2.748 inches
Depth from upper-edge of DIN-rail	62.6 mm / 2.465 inches

### Mechanical data

Mounting type	DIN-35 rail
Pluggable connector	fixed

### Material data

Color	light gray
Housing material	Polycarbonate; polyamide 6.6
Fire load	0.896 MJ
Weight	50.7 g
Conformity marking	CE

### Environmental requirements

Ambient temperature (operation)	-20 ... +60 °C
Ambient temperature (storage)	-40 ... +85 °C
Protection type	IP20
Pollution degree	2 per IEC 61131-2
Operating altitude	0 ... 2000 m / 0 ... 6562 ft
Mounting position	Horizontal left, horizontal right, horizontal top, horizontal bottom, vertical top and vertical bottom
Relative humidity (without condensation)	95 %
Relative humidity (with condensation)	Short-term condensation per Class 3K6/IEC EN 60721-3-3 and E-DIN 40046-721-3, accounting for a temperature range of -20 to +60 °C (except for wind-driven precipitation, water and ice formation)
Vibration resistance	4g per IEC 60068-2-6
Shock resistance	15g per IEC 60068-2-27
EMC immunity to interference	per EN 61000-6-2, marine applications
EMC emission of interference	per EN 61000-6-4, marine applications
Exposure to pollutants	per IEC 60068-2-42 and IEC 60068-2-43
Permissible H <sub>2</sub> S contaminant concentration at a relative humidity 75 %	10 ppm
Permissible SO <sub>2</sub> contaminant concentration at a relative humidity 75 %	25 ppm

### Commercial data

Product Group	15 (I/O System)
PU (SPU)	1 pcs
Packaging type	Box
Country of origin	DE
GTIN	4045454504342
Customs tariff number	85389099990

### Product Classification

UNSPSC	32101505
eCl@ss 10.0	27-24-26-01
eCl@ss 9.0	27-24-26-01
ETIM 9.0	EC001596
ETIM 10.0	EC001596
ECCN	NO US CLASSIFICATION

### Environmental Product Compliance

CAS-No.	1303-86-2 1317-36-8 25550-51-0 7439-92-1
REACH Candidate List Substance	4-Methyl-1,2-cyclohexanedicarboxylic anhydride Diboron trioxide Lead Lead monoxide
RoHS Compliance Status	Compliant,With Exemption
RoHS Exemption	6(c) 7(a) 7(c)-I 7(c)-II
SCIP notification number (Austria)	42a91ab6-2a04-401f-81cf-2820f903124f
SCIP notification number (Belgium)	da26b909-3e3f-4267-81d3-03d1c26a5df0
SCIP notification number (Bulgaria)	ce538cc9-0ed9-4ea6-b300-47a81015e9d2
SCIP notification number (Czech Republic)	a3f0c5fe-dad6-4ef7-a5d7-077896348bae
SCIP notification number (Denmark)	0f745361-c5df-4274-bf4d-4ca0180dbdaa
SCIP notification number (Finland)	97c04365-5bbe-4f59-bc51-8e3b7c0c4631
SCIP notification number (France)	502f9b79-b0aa-497c-8df8-2f15e29b19e7
SCIP notification number (Germany)	2d4c8033-495d-4f15-8364-56135e0c9de7
SCIP notification number (Hungary)	54a6d1a7-7771-489e-b639-4b03bac940b1
SCIP notification number (Italy)	0c32046c-e622-4109-8286-a72a84ced97c
SCIP notification number (Netherlands)	1af9a4e3-f485-437d-8ba1-d19a42360483
SCIP notification number (Poland)	f95ae5b1-239d-4b90-87f4-8704ffec333f
SCIP notification number (Romania)	23084338-ffa-4c89-8c89-19c116f112b0
SCIP notification number (Sweden)	e4399466-db12-4505-b1db-79d2034828ae

**Approvals / Certificates**

**General approvals**



Approval	Standard	Certificate Name
EAC GZO Almaty Standart	TP TC 020/2011	EAC CoC 03083
KC National Radio Research Agency	Article 58-2, Clause 3	MSIP-REM-W43-AOM750
UL Underwriters Laboratories Inc. (ORDINARY LOCATIONS)	UL 508	E175199

**Declarations of conformity and manufacturer's declarations**

Approval	Standard	Certificate Name
EU-Declaration of Conformity WAGO GmbH & Co. KG	-	-
EU-Declaration of Conformity WAGO GmbH & Co. KG	-	-
UK-Declaration of Conformity WAGO GmbH & Co. KG	-	-
UK-Declaration of Conformity WAGO GmbH & Co. KG	-	-

**Approvals for marine applications**



Approval	Standard	Certificate Name
ABS American Bureau of Shipping	-	22-2227356-PDA
BSH Bundesamt fuer Seeschiff-fahrt und Hydrographie	-	1104
DNV DNV Germany GmbH	DNV-CG-0339, Aug. 2021	TAA00001J4
LR Lloyds Register	-	LR2475997TA
PRS Polski Rejestr Statków	-	TE/1102/880590/23

**Approvals for hazardous areas**



Approval	Standard	Certificate Name
ATEX TUEV Nord Cert GmbH	EN 60079-0	TUEV14ATEX148929X (II 3 G Ex ec IIC T4 Gc)
CCCEX CQST/CNEX	CNCA-C23-01	2020312310000213 (Ex ec IIC T4 Gc)
INMETRO TÜV Rheinland do Brasil Ltda.	IEC 60079-0	TÜV 12.1297 X
UKEX WAGO GmbH & Co. KG	EN 60079-0	UKCA_WA GO22UKEX003X_ec
UL Underwriters Laboratories Inc. (HAZARDOUS LOCATIONS)	UL 121201	E198726

**Downloads**

**Environmental Product Compliance**

Compliance Search
Environmental Product Compliance 750-559/025-000

**Documentation**

Manual
Product Manual 4-channel, 0 - 10VDC 2476253835   4   en-US   2026-02-25 10:35 12.03.2026 pdf 874.96 KB
System Manual Series 750/753

System Description
750/753 Series I/O-System – General Product Information pdf 953.35 KB
Overview on WAGO-I/O-SYSTEM 750 approvals pdf 770.48 KB

Bid Text			
750-559/025-000	19.02.2019	xml 4.43 KB	<a href="#">↓</a>
750-559/025-000	05.03.2019	docx 17.27 KB	<a href="#">↓</a>

Instruction Leaflet			
CCC Ex (Additional information)	26.04.2023	pdf 159.76 KB	<a href="#">↓</a>

CAD/CAE-Data	
<b>CAD data</b> 2D/3D Models 750-559/025-000 <a href="#">↓</a>	<b>CAE data</b> EPLAN Data Portal 750-559/025-000 <a href="#">↓</a>  WSCAD Universe 750-559/025-000 <a href="#">↓</a>  ZUKEN Portal 750-559/025-000 <a href="#">↓</a>

Device Files			
<b>Device Driver</b>			
WAGO USB Service Kabel Treiber / Serie 750 und 857	6.5.3.0 10.09.2014	zip 4721.96 KB	<a href="#">↓</a>

## 1 Compatible Products

### 1.1 Optional Accessories

#### 1.1.1 DIN-rail

##### 1.1.1.1 Mounting accessories



**Item No.: 210-196**  
 Aluminum carrier rail; 35 x 8.2 mm; 1.6 mm thick; 2 m long; unslotted; similar to EN 60715; silver-colored



**Item No.: 210-198**  
 Copper carrier rail; 35 x 15 mm; 2.3 mm thick; 2 m long; unslotted; according to EN 60715; copper-colored



**Item No.: 210-197**  
 Steel carrier rail; 35 x 15 mm; 1.5 mm thick; 2 m long; slotted; similar to EN 60715; silver-colored



**Item No.: 210-114**  
 Steel carrier rail; 35 x 15 mm; 1.5 mm thick; 2 m long; unslotted; similar to EN 60715; silver-colored



**Item No.: 210-118**  
 Steel carrier rail; 35 x 15 mm; 2.3 mm thick; 2 m long; unslotted; according to EN 60715; silver-colored



**Item No.: 210-115**  
 Steel carrier rail; 35 x 7.5 mm; 1 mm thick; 2 m long; slotted; according to EN 60715; "Hole width 18 mm; silver-colored



**Item No.: 210-112**  
 Steel carrier rail; 35 x 7.5 mm; 1 mm thick; 2 m long; slotted; according to EN 60715; "Hole width 25 mm; silver-colored



**Item No.: 210-113**  
 Steel carrier rail; 35 x 7.5 mm; 1 mm thick; 2 m long; unslotted; according to EN 60715; silver-colored











### 1.1.2 Marking

#### 1.1.2.1 Group marker carrier



**Item No.: 750-106**  
 Group marker carrier

**1.1.2.2 Marker**







 <p><b>Item No.: 750-100</b> Marker card; as a DIN A4 sheet; plain</p>	<p><b>Item No.: 2009-145/000-006</b> Mini-WSB Inline; for Smart Printer; 1700 pieces on roll; stretchable 5 - 5.2 mm; plain; snap-on type; blue</p>	<p><b>Item No.: 2009-145/000-007</b> Mini-WSB Inline; for Smart Printer; 1700 pieces on roll; stretchable 5 - 5.2 mm; plain; snap-on type; gray</p>	<p><b>Item No.: 2009-145/000-023</b> Mini-WSB Inline; for Smart Printer; 1700 pieces on roll; stretchable 5 - 5.2 mm; plain; snap-on type; green</p>
<p><b>Item No.: 2009-145/000-012</b> Mini-WSB Inline; for Smart Printer; 1700 pieces on roll; stretchable 5 - 5.2 mm; plain; snap-on type; orange</p>	<p><b>Item No.: 2009-145/000-005</b> Mini-WSB Inline; for Smart Printer; 1700 pieces on roll; stretchable 5 - 5.2 mm; plain; snap-on type; red</p>	<p><b>Item No.: 2009-145/000-024</b> Mini-WSB Inline; for Smart Printer; 1700 pieces on roll; stretchable 5 - 5.2 mm; plain; snap-on type; violet</p>	<p><b>Item No.: 2009-145</b> Mini-WSB Inline; for Smart Printer; 1700 pieces on roll; stretchable 5 - 5.2 mm; plain; snap-on type; white</p>
<p><b>Item No.: 2009-145/000-002</b> Mini-WSB Inline; for Smart Printer; 1700 pieces on roll; stretchable 5 - 5.2 mm; plain; snap-on type; yellow</p>	 <p><b>Item No.: 248-501/000-006</b> Mini-WSB marking card; as card; not stretchable; plain; snap-on type; blue</p>	 <p><b>Item No.: 248-501/000-007</b> Mini-WSB marking card; as card; not stretchable; plain; snap-on type; gray</p>	 <p><b>Item No.: 248-501/000-023</b> Mini-WSB marking card; as card; not stretchable; plain; snap-on type; green</p>
 <p><b>Item No.: 248-501/000-017</b> Mini-WSB marking card; as card; not stretchable; plain; snap-on type; light green</p>	 <p><b>Item No.: 248-501/000-012</b> Mini-WSB marking card; as card; not stretchable; plain; snap-on type; orange</p>	 <p><b>Item No.: 248-501/000-005</b> Mini-WSB marking card; as card; not stretchable; plain; snap-on type; red</p>	 <p><b>Item No.: 248-501/000-024</b> Mini-WSB marking card; as card; not stretchable; plain; snap-on type; violet</p>
 <p><b>Item No.: 248-501</b> Mini-WSB marking card; as card; not stretchable; plain; snap-on type; white</p>	 <p><b>Item No.: 248-501/000-002</b> Mini-WSB marking card; as card; not stretchable; plain; snap-on type; yellow</p>		

**1.1.2.3 Marker carrier**

 <p><b>Item No.: 750-103</b> Group marker carrier</p>
--

**1.1.3 Shield termination**

**1.1.3.1 Shield clamping saddles**

 <p><b>Item No.: 790-108</b> Shield clamping saddle; 11 mm wide; diameter of compatible conductor; 3 ... 8 mm</p>	 <p><b>Item No.: 790-208</b> Shield clamping saddle; 12.4 mm wide; 3 ... 8 mm</p>	 <p><b>Item No.: 790-116</b> Shield clamping saddle; 19 mm wide; diameter of compatible conductor; 7 ... 16 mm</p>	 <p><b>Item No.: 790-216</b> Shield clamping saddle; 21.8 mm wide; 6 ... 16 mm</p>
 <p><b>Item No.: 790-124</b> Shield clamping saddle; 27 mm wide; diameter of compatible conductor; 6 ... 24 mm</p>	 <p><b>Item No.: 790-220</b> Shield clamping saddle; 30 mm wide; 6 ... 20 mm</p>	 <p><b>Item No.: 790-140</b> Shield clamping saddle; diameter of compatible conductor</p>	

1.1.4 System enclosure

1.1.4.1 System enclosure



**Item No.: 850-825**  
IP65 enclosure; Aluminium (RAL 7032); Wx-HxD (160x100x160 mm); 9 x M12, 4 x M20



**Item No.: 850-826**  
IP65 enclosure; Aluminium (RAL 7032); Wx-HxD (240x100x160 mm); 4 x M20, 4 x M16, 14 x M12 cable grip



**Item No.: 850-827**  
IP65 enclosure; Aluminium (RAL 7032); Wx-HxD (320x100x160 mm); 4 x M20, 8 x M16, 17 x M12 cable grip



**Item No.: 850-828**  
IP65 enclosure; Aluminium (RAL 7032); Wx-HxD (480x100x160 mm); 4 x M20, 10 x M16, 35 x M12 cable grip



**Item No.: 850-826/002-000**  
IP65 enclosure; Aluminium (RAL 7035); Wx-HxD (240x100x160 mm); 4 x M20, 4 x M16, 14 x M12 cable grip



**Item No.: 850-827/002-000**  
IP65 enclosure; Aluminium (RAL 7035); Wx-HxD (320x100x160 mm); 4 x M20, 8 x M16, 17 x M12 cable grip



**Item No.: 850-828/002-000**  
IP65 enclosure; Aluminium (RAL 7035); Wx-HxD (480x100x160 mm); 4 x M20, 10 x M16, 35 x M12 cable grip



**Item No.: 850-834**  
IP65 enclosure; Polyester (RAL 7032); Wx-HxD (164x100x164 mm); 9 x M12, 4 x M20



**Item No.: 850-835**  
IP65 enclosure; Polyester (RAL 7032); Wx-HxD (244x100x164 mm); 4 x M20, 4 x M16, 14 x M12 cable grip



**Item No.: 850-836**  
IP65 enclosure; Polyester (RAL 7032); Wx-HxD (324x100x164 mm); 4 x M20, 8 x M16, 17 x M12 cable grip



**Item No.: 850-814/002-000**  
IP65 enclosure; Sheet steel (RAL 7035); Wx-HxD (200x120x200 mm); without flange plate



**Item No.: 850-815/002-000**  
IP65 enclosure; Sheet steel (RAL 7035); Wx-HxD (300x120x200 mm); without flange plate



**Item No.: 850-816/002-000**  
IP65 enclosure; Sheet steel (RAL 7035); Wx-HxD (400x120x200 mm); without flange plate



**Item No.: 850-817/002-000**  
IP65 enclosure; Sheet steel (RAL 7035); Wx-HxD (600x120x200 mm); without flange plate