

B2CF 3.50/24/180LR SN BK BX

Weidmüller Interface GmbH & Co. KG
 Klingenbergstraße 26
 D-32758 Detmold
 Germany

www.weidmueller.com

Product image

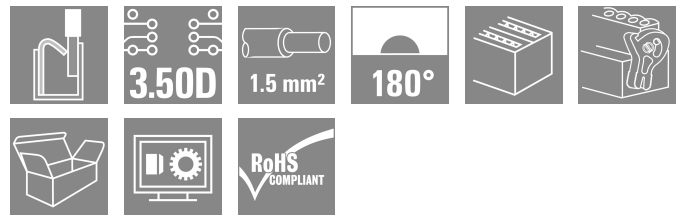
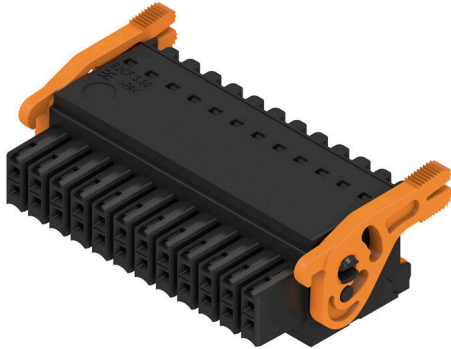

Two-row female plug with PUSH IN spring connection

- Simply insert the prepared wire - and you're done
- Intuitive to use because
- the wire-entry area and handling area are clearly separated
- Integrated push-buttons for opening the terminal point
- High component density because of low heights
- Optional: locking and releasing require no tools when using Weidmüller's release latch (LR) or release lever (LH)

General ordering data

Version	PCB plug-in connector, female plug, 3.50 mm, Number of poles: 24, 180°, PUSH IN with actuator, Clamping range, max. : 1.5 mm², Box
Order No.	1278340000
Type	B2CF 3.50/24/180LR SN BK BX
GTIN (EAN)	4050118067927
Qty.	36 items
Product data	IEC: 320 V / 13.4 A / 0.14 - 1.5 mm² UL: 300 V / 9.5 A / AWG 30 - AWG 16
Packaging	Box

Creation date 01.03.2026 11:17:47 MEZ

Catalogue status / Drawings

B2CF 3.50/24/180LR SN BK BX

Weidmüller Interface GmbH & Co. KG
Klingenbergstraße 26
D-32758 Detmold
Germany

www.weidmueller.com

Technical data**Approvals**

Approvals



ROHS	Conform
UL File Number Search	UL Website
Certificate No. (cURus)	E60693

Dimensions and weights

Depth	29.9 mm	Depth (inches)	1.1772 inch
Height	17.25 mm	Height (inches)	0.6791 inch
Width	48.9 mm	Width (inches)	1.9252 inch
Net weight	16.52 g		

Environmental Product Compliance

RoHS Compliance Status	Compliant without exemption		
REACH SVHC	No SVHC above 0.1 wt%		
Product Carbon Footprint	Cradle to gate	0.406 kg CO2eq.	

System Parameters

Product family	OMNIMATE Signal - series B2C/S2C 3.50 - 2-row	Type of connection	Field connection
Wire connection method	PUSH IN with actuator	Pitch in mm (P)	3.50 mm
Pitch in inches (P)	0.138 "	Conductor outlet direction	180°
Number of poles	24	L1 in mm	38.50 mm
L1 in inches	1.516 "	Number of rows	1
Pin series quantity	2	Rated cross-section	15 mm ²
Touch-safe protection acc. to DIN VDE 57 106	Safe from finger touch	Touch-safe protection acc. to DIN VDE 0470	IP20 plugged
Protection degree	IP20, when fully mounted	Can be coded	Yes
Stripping length	10 mm	Screwdriver blade	0.4 x 2.5
Screwdriver blade standard	DIN 5264	Plugging cycles	25
Plugging force/pole, max.	3.5 N	Pulling force/pole, max.	3.5 N

Material data

Insulating material	PA 66 GF 30	Colour	black
Colour of operational elements	orange	Colour chart (similar)	RAL 9011
Insulating material group	II	Comparative Tracking Index (CTI)	≥ 600
Insulation resistance	≥ 108 Ω	Moisture Level (MSL)	
UL 94 flammability rating	V-0	Contact material	Copper alloy
Contact surface	tinned	Layer structure of plug contact	2...5 µm Sn hot-dip tinned
Storage temperature, min.	-40 °C	Storage temperature, max.	70 °C
Operating temperature, min.	-50 °C	Operating temperature, max.	120 °C
Temperature range, installation, min.	-40 °C	Temperature range, installation, max.	120 °C

Conductors suitable for connection

Clamping range, min.	0.14 mm ²
Clamping range, max.	1.5 mm ²
Wire connection cross section AWG, min.	AWG 30

Creation date 01.03.2026 11:17:47 MEZ

Catalogue status / Drawings

B2CF 3.50/24/180LR SN BK BX

Weidmüller Interface GmbH & Co. KG
 Klingenbergstraße 26
 D-32758 Detmold
 Germany

www.weidmueller.com

Technical data

Wire connection cross section AWG, max.	AWG 16
Solid, min. H05(07) V-U	0.14 mm ²
Solid, max. H05(07) V-U	1.5 mm ²
Flexible, min. H05(07) V-K	0.14 mm ²
Flexible, max. H05(07) V-K	1.5 mm ²
w. plastic collar ferrule, DIN 46228 pt 4, min.	0.14 mm ²
w. plastic collar ferrule, DIN 46228 pt 4, max.	1 mm ²
w. wire end ferrule, DIN 46228 pt 1, min.	0.14 mm ²
w. wire end ferrule, DIN 46228 pt 1, max.	1.5 mm ²

Clampable conductor	Cross-section for conductor connection	
	wire end ferrule	nominal 0.14 mm ²
wire end ferrule	Stripping length	nominal 10 mm
	Recommended wire-end ferrule	H0.14/12 GR SV
Cross-section for conductor connection	nominal	0.25 mm ²
	wire end ferrule	nominal 10 mm
wire end ferrule	Stripping length	nominal 10 mm
	Recommended wire-end ferrule	H0.25/12 HBL SV
Cross-section for conductor connection	nominal	0.34 mm ²
	wire end ferrule	nominal 10 mm
wire end ferrule	Stripping length	nominal 10 mm
	Recommended wire-end ferrule	H0.34/12 TK SV
Cross-section for conductor connection	nominal	0.5 mm ²
	wire end ferrule	nominal 12 mm
wire end ferrule	Stripping length	nominal 12 mm
	Recommended wire-end ferrule	H0.5/16 OR SV
wire end ferrule	Stripping length	nominal 10 mm
	Recommended wire-end ferrule	H0.5/10
Cross-section for conductor connection	nominal	0.75 mm ²
	wire end ferrule	nominal 12 mm
wire end ferrule	Stripping length	nominal 12 mm
	Recommended wire-end ferrule	H0.75/16 W SV
wire end ferrule	Stripping length	nominal 10 mm
	Recommended wire-end ferrule	H0.75/10
Cross-section for conductor connection	nominal	1
	wire end ferrule	nominal 12 mm
wire end ferrule	Stripping length	nominal 12 mm
	Recommended wire-end ferrule	H1.0/16 GE SV
wire end ferrule	Stripping length	nominal 10 mm
	Recommended wire-end ferrule	H1.0/10
Cross-section for conductor connection	nominal	1.5 mm ²
	wire end ferrule	nominal 10 mm
wire end ferrule	Stripping length	nominal 10 mm
	Recommended wire-end ferrule	H1.5/10

Reference text The outside diameter of the plastic collar should not be larger than the pitch (P), Length of ferrules is to be chosen depending on the product and the rated voltage.

Rated data acc. to IEC

tested acc. to standard	IEC 60664-1, IEC 61984	Rated current, min. number of poles (Tu=20°C)	13.4 A
Rated current, max. number of poles (Tu=20°C)	10 A	Rated current, min. number of poles (Tu=40°C)	12 A

B2CF 3.50/24/180LR SN BK BX

Weidmüller Interface GmbH & Co. KG

 Klingenbergstraße 26
 D-32758 Detmold
 Germany

www.weidmueller.com

Technical data

Rated current, max. number of poles (Tu=40°C)	9 A	Rated voltage for surge voltage class / pollution degree II/2	320 V
Rated voltage for surge voltage class / pollution degree III/2	160 V	Rated voltage for surge voltage class / pollution degree III/3	160 V
Rated impulse voltage for surge voltage class/ pollution degree II/2	2.5 kV	Rated impulse voltage for surge voltage class/ pollution degree III/2	2.5 kV
Rated impulse voltage for surge voltage class/ contamination degree III/3	2.5 kV	Short-time withstand current resistance	3 x 1s with 80 A

Rated data acc. to CSA

Institute (CSA)	CSA	Certificate No. (CSA)	200039-1121690
Rated voltage (Use group B / CSA)	300 V	Rated voltage (Use group C / CSA)	50 V
Rated voltage (Use group D / CSA)	300 V	Rated current (Use group B / CSA)	9.5 A
Rated current (Use group C / CSA)	9.5 A	Rated current (Use group D / CSA)	9.5 A
Wire cross-section, AWG, min.	AWG 30	Wire cross-section, AWG, max.	AWG 16
Reference to approval values	Specifications are maximum values, details - see approval certificate.		

Rated data acc. to UL 1059

Institute (cURus)	CURUS	Certificate No. (cURus)	E60693
Rated voltage (Use group B / UL 1059)	300 V	Rated voltage (Use group C / UL 1059)	50 V
Rated voltage (Use group D / UL 1059)	300 V	Rated current (Use group B / UL 1059)	9.5 A
Rated current (Use group C / UL 1059)	9.5 A	Rated current (Use group D / UL 1059)	9.5 A
Wire cross-section, AWG, min.	AWG 30	Wire cross-section, AWG, max.	AWG 16
Reference to approval values	Specifications are maximum values, details - see approval certificate.		

Packing

Packaging	Box	VPE length	353.00 mm
VPE width	138.00 mm	VPE height	38.00 mm

Type tests

Test: Durability of markings	Standard	IEC 61984 section 6.2 and 7.3.2 / 10.11 taking pattern from IEC 60068-2-70 / 12.95	
	Test	mark of origin, type identification, pitch, type of material, date clock, approval marking UL, approval marking cULus	
	Evaluation	available	
	Test	durability	
Test: Misengagement (Non-interchangeability)	Evaluation	passed	
	Standard	IEC 61984 section 6.3 and 6.9.1 / 10.11, IEC 60512-13-5 / 02.06	
	Test	180° turned without coding elements	
	Evaluation	passed	
	Test	180° turned with coding elements	
	Evaluation	passed	
Test: Clampable cross section	Standard	IEC 60999-1 section 7 and 9.1 / 11.99, IEC 60947-1 section 8.2.4.5.1 / 03.11	
	Conductor type	Type of conductor	solid 0.14 mm ²
		and conductor cross-section	

B2CF 3.50/24/180LR SN BK BX

Weidmüller Interface GmbH & Co. KG
 Klingenbergstraße 26
 D-32758 Detmold
 Germany

www.weidmueller.com

Technical data

Conductor type	Type of conductor and conductor cross-section	H05V-U0.75
	Type of conductor and conductor cross-section	H05V-K0.75
Evaluation	passed	
Requirement	≥40 N	
Conductor type	Type of conductor and conductor cross-section	H07V-U1.5
	Type of conductor and conductor cross-section	H07V-K1.5
	Type of conductor and conductor cross-section	AWG 16/1
	Type of conductor and conductor cross-section	AWG 16/19
Evaluation	passed	

Important note

IPC conformity Conformity: The products are developed, manufactured and delivered according international recognized standards and norms and comply with the assured properties in the data sheet resp. fulfill decorative properties in accordance with IPC-A-610 "Class 2". Further claims on the products can be evaluated on request.

- Notes**
- Additional variants on request
 - Gold-plated contact surfaces on request
 - Rated current related to rated cross-section & min. No. of poles.
 - Crimp shape A for wire-end ferrules with crimping tools PZ 1,5 (order no. 9005990000) or PZ 6/5 (order no. 9011460000) for larger wire cross-sections recommended.
 - P on drawing = pitch
 - Rated data refer only to the component itself. Clearance and creepage distances to other components are to be designed in accordance with the relevant application standards.
 - Max. outer diameter of the conductor 2.6 mm
 - In accordance with IEC 61984, OMNIMATE-connectors are connectors without breaking capacity (COC). During designated use, connectors are not allowed to be engaged or disengaged when live or under load
 - Long term storage of the product with average temperature of 50 °C and maximum humidity 70%, 36 months

Classifications

ETIM 8.0	EC002638	ETIM 9.0	EC002638
ETIM 10.0	EC002638	ECLASS 14.0	27-46-02-02
ECLASS 15.0	27-46-02-02		

B2CF 3.50/24/180LR SN BK BX

Weidmüller Interface GmbH & Co. KG
 Klingenbergstraße 26
 D-32758 Detmold
 Germany

www.weidmueller.com

Drawings

Product image

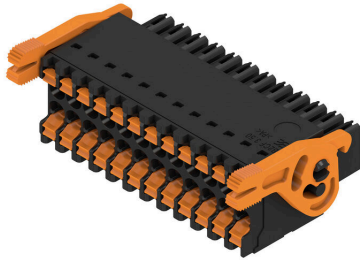

Dimensional drawing

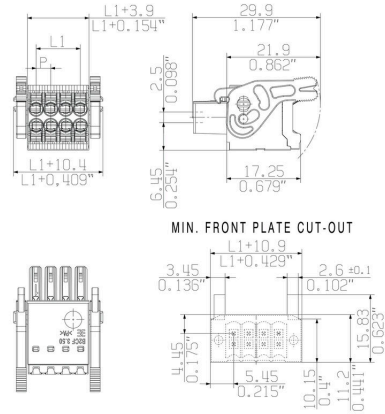

Graph

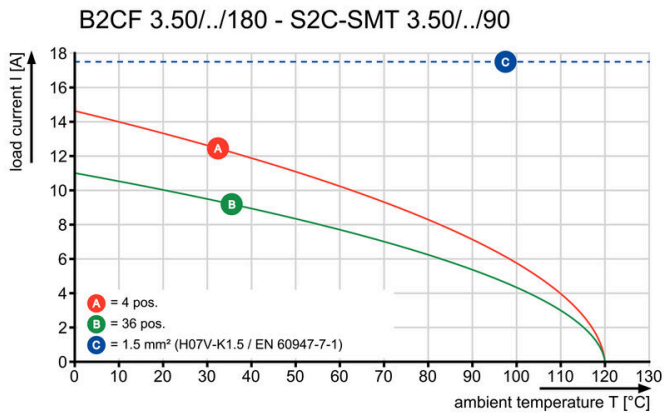

Product benefits

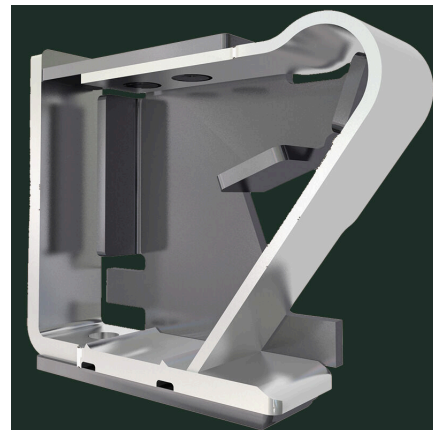

Solid PUSH IN contactSafe and durable

B2CF 3.50/24/180LR SN BK BX

Weidmüller Interface GmbH & Co. KG
Klingenbergstraße 26
D-32758 Detmold
Germany

www.weidmueller.com

Drawings

Product benefits

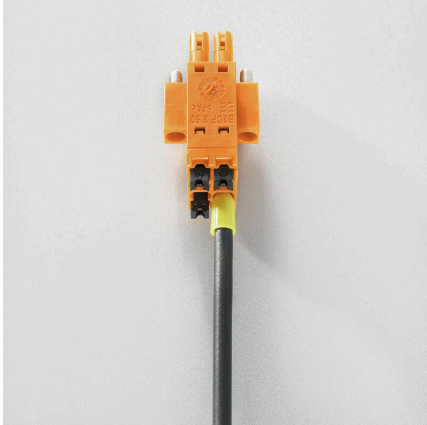

Large connection cross-section Up to 1.5 mm possible with ease

Product benefits

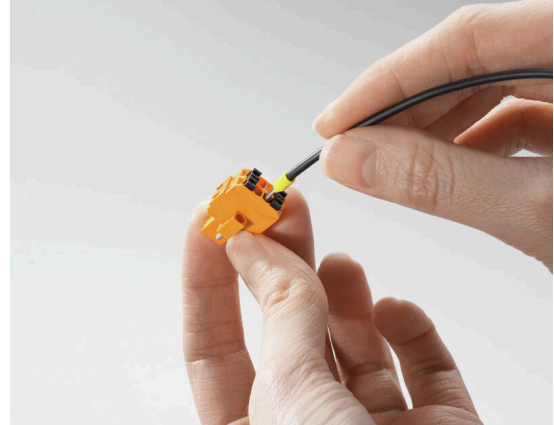

Fast PUSH IN connection Tool-free and touch-safe

Example of use

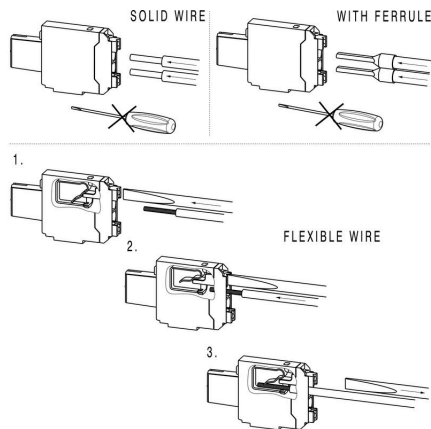

B2CF 3.50/24/180LR SN BK BX

Weidmüller Interface GmbH & Co. KG
 Klingenbergstraße 26
 D-32758 Detmold
 Germany

www.weidmueller.com

Accessories

Coding elements



Only connects what is supposed to be connected: the right connection at the right place.
 Coding elements and locking devices clearly assign connecting elements during the manufacturing process and operation
 The coding elements and locking devices are inserted prior to assembly or during the cable assembly phase. The Weidmüller alternative: configure online using the variant configurator to precode prior to delivery. Incorrect assembly on the circuit board and incorrect plugging of connecting elements is no longer possible. The advantage: no troubleshooting during manufacture and no operational errors by the user.

General ordering data

Type	B2L/S2L 3.50 KO BK BX	Version
Order No.	1849740000	PCB plug-in connector, Accessories, Coding element, black, Number
GTIN (EAN)	4032248378203	of poles: 1
Qty.	100 ST	
Type	B2L/S2L 3.50 KO OR BX	Version
Order No.	1849730000	PCB plug-in connector, Accessories, Coding element, orange, Number
GTIN (EAN)	4032248378197	of poles: 1
Qty.	100 ST	

B2CF 3.50/24/180LR SN BK BX

Weidmüller Interface GmbH & Co. KG
 Klingenbergstraße 26
 D-32758 Detmold
 Germany

www.weidmueller.com

Counterpart

S2C-SMT 3.50/180LF Box

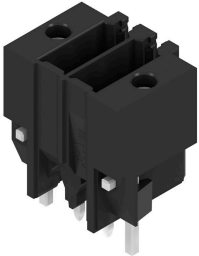

High-temperature-resistant pin header.

- touch-safe
- can be plugged into B2CF 3.50 PUSH IN female plug
- Plug-in direction is perpendicular or parallel to the circuit board (180° / 90°)
- Housing variants: closed (G) and with solder flange (LF)
- Box packaging (BX) or, anti-static, tape-on-reel (RL)
- Suitable for reflow and wave soldering applications
- Pin length of either 1.5 mm or 3.5 mm

General ordering data

Type	S2C-SMT 3.50/24/180LF 3...	Version
Order No.	1290330000	PCB plug-in connector, male header, Solder flange, THT/THR solder
GTIN (EAN)	4050118082821	connection, 3.50 mm, Number of poles: 24, 180°, Solder pin length
Qty.	36 ST	(l): 3.5 mm, tinned, black, Box

S2C-SMT 3.50/90LF Box



High-temperature-resistant male header

- Finger-safe
- Can be plugged into female plug B2CF 3.50 PUSH IN
- Plug-in direction is perpendicular or parallel to the circuit board (180° / 90°)
- Housing variants: closed (G) and with solder flange (LF)
- Packed either in a box (BX) or on anti-static tape-on-reel (RL)
- Suitable for reflow and wave soldering applications
- Pin length of either 1.5 mm or 3.2 mm

General ordering data

Type	S2C-SMT 3.50/24/90LF 1...	Version
Order No.	1289960000	PCB plug-in connector, male header, Solder flange, THT/THR solder
GTIN (EAN)	4050118082753	connection, 3.50 mm, Number of poles: 24, 90°, Solder pin length (l):
Qty.	36 ST	1.5 mm, tinned, black, Box
Type	S2C-SMT 3.50/24/90LF 3...	Version
Order No.	1289550000	PCB plug-in connector, male header, Solder flange, THT/THR solder
GTIN (EAN)	4050118082272	connection, 3.50 mm, Number of poles: 24, 90°, Solder pin length (l):
Qty.	36 ST	3.2 mm, tinned, black, Box