

IEC Appliance Inlet C14 or C18 with Line Switch 1- or 2-pole



Screw-on mounting  
Non-illuminated  
from front side



Snap-in version  
Non-illuminated



Screw-on mounting and line Switch illuminated  
green



See below:  
[Approvals and Compliances](#)

**Description**

- Panel mount :  
Screw-on version from front or rear side, snap-in version front side
- Appliance Inlet protection class I or II , Line Switch 1- or 2-pole
- V-Lock notch standard
- Quick connect terminals 4.8 x 0.8 mm

**Unique Selling Proposition**

- Ultra compact design
- Line switch for high inrush currents
- Components internally wired
- V-Lock cord retaining

**Characteristics**

- All single elements are already wired
- Unwired versions available on request
- Line switch non-illuminated or illuminated
- Ideal for application with high transient loads
- Suitable for use in equipment according to IEC/UL 62368-1

**Other versions on request**

- Unwired versions
- Solder terminals
- Line switch with other rocker marking

**References**

Alternative: version with line filter [DC12](#)  
 Substitute for type [6010-K](#); [KEB1](#); [KEB2](#)

**Weblinks**

[pdf data sheet](#), [html datasheet](#), [General Product Information](#), [Approvals](#), [Distributor-Stock-Check](#), [Accessories](#), [Detailed request for product](#)

**Technical Data**

|                                   |   |                         |   |
|-----------------------------------|---|-------------------------|---|
| Ratings IEC                       | 10A / 250VAC; 50Hz  | Appliance inlet/-outlet | C14 / C18 acc. to IEC 60320-1, UL 60320-1, CSA C22.2 no. 60320-1 (for cold conditions) pin-temperature 70 °C, 10A, Protection Class I or II |
| Ratings UL/CSA                    | 15A / 250VAC; 60Hz  | Line Switch             | Rocker switch 1-/2-pole, non-illuminated or illuminated, acc. to IEC 61058-1 <a href="#">Technical Details</a>                              |
| Dielectric Strength               | > 2.5 kVAC between L-N<br>> 3 kVAC between L/N-PE (1 min/50Hz)                  |                         |   |
| Allowable Operation Temperature   | -25 °C to 70 °C   |                         |   |
| IP-Protection                     | front side IP40 acc. to IEC 60529   |                         |   |
| Protection against electric shock | Suitable for appliances with protection class I or II acc. to IEC 61140         |                         |   |
| Terminal                          | Quick connect terminals 4.8 x 0.8 mm  |                         |   |
| Panel Thickness S                 | Screw: max 6 mm<br>Mounting screw torque max 0.5Nm<br>Snap-in: 1/1.5/2/2.5/3 mm |                         |   |
| Material: Housing                 | Thermoplastic, black, UL 94V-0  |                         |   |

**Approvals and Compliances**



Detailed information on product approvals, code requirements, usage instructions and detailed test conditions can be looked up in [Details about Approvals](#)

SCHURTER products are designed for use in industrial environments. They have approvals from independent testing bodies according to national and international standards. Products with specific characteristics and requirements such as required in the automotive sector according to IATF 16949, medical technology according to ISO 13485 or in the aerospace industry can be offered exclusively with customer-specific, individual agreements by SCHURTER.

## Approvals





The approval mark is used by the testing authorities to certify compliance with the safety requirements placed on electronic products.

Approval Reference Type: DC11

| Approval Logo  | Certificates  | Certification Body | Description                              |
|--|---------------|--------------------|--|
|  | VDE Approvals | VDE                | Certificate Number: 40007009             |
|  | UL Approvals  | UL                 | UR File Number: E96454                   |
|  | CCC Approvals | CCC                | CCC Certificate Number: 2013010204594013 |



## Product standards

Product standards that are referenced

| Organization   | Design                | Standard              | Description   |
|--|-----------------------|-----------------------|---|
|  | Designed according to | IEC 60320-1           | Appliance couplers for household and similar general purposes         |
|  | Designed according to | IEC 61058-1           | Switches for appliances. Part 1. General requirements                 |
|  | Designed according to | UL 60320-1            | Standard for Attachment Plugs and Receptacles                         |
|  | Designed according to | CSA C22.2 no. 60320-1 | General Use Receptacles, Attachment Plugs, and Similar Wiring Devices |







## Application standards

Application standards where the product can be used

| Organization   | Design                         | Standard       | Description  |
|--|--------------------------------|----------------|--|
|   | Suitable for applications acc. | IEC/UL 62368-1 | Audio/video, information and communication technology equipment - Part 1: Safety requirements  |
|  | Suitable for applications acc. | IEC 60335-1    | Safety of electrical appliances for household and similar purposes. Meets the requirements for appliances in unattended use. This includes the enhanced requirements of glow wire tests acc. to IEC 60695-2-11 or -12 & -13. |

## Compliances

The product complies with following Guide Lines

| Identification   | Details  | Initiator   | Description  |
|--|--|-------------|--|
|  | <a href="#">CE declaration of conformity</a>   | SCHURTER AG | The CE marking declares that the product complies with the applicable requirements laid down in the harmonisation of Community legislation on its affixing in accordance with EU Regulation 765/2008.                        |
|  | <a href="#">UKCA declaration of conformity</a> | SCHURTER AG | The UKCA marking declares that the product complies with the applicable requirements laid down in the British Amendment of Regulation (EC) 765/2008.   |
|  | RoHS   | SCHURTER AG | Directive RoHS 2011/65/EU, Amendment (EU) 2015/863   |
|  | China RoHS                                     | SCHURTER AG | The law SJ / T 11363-2006 (China RoHS) has been in force since 1 March 2007. It is similar to the EU directive RoHS.   |
|  | REACH  | SCHURTER AG | On 1 June 2007, Regulation (EC) No 1907/2006 on the Registration, Evaluation, Authorization and Restriction of Chemicals 1 (abbreviated as "REACH") entered into force.  |
|  |  | SCHURTER AG | V-Lock system are based on a matching plug-dose combination. The connector is equipped with a notch intended for use with the latching cordset. The cord latching system prevents against accidental removal of the cordset. |
|  | <a href="#">White Paper Glow wire test</a>     | SCHURTER AG | Meets the requirements of IEC 60335-1 for appliances in unattended use. This includes the enhanced requirements of glow wire tests acc. to IEC 60695-2-11 or -12 & -13.  |

**Dimensions [mm]**

Screw-on mounting

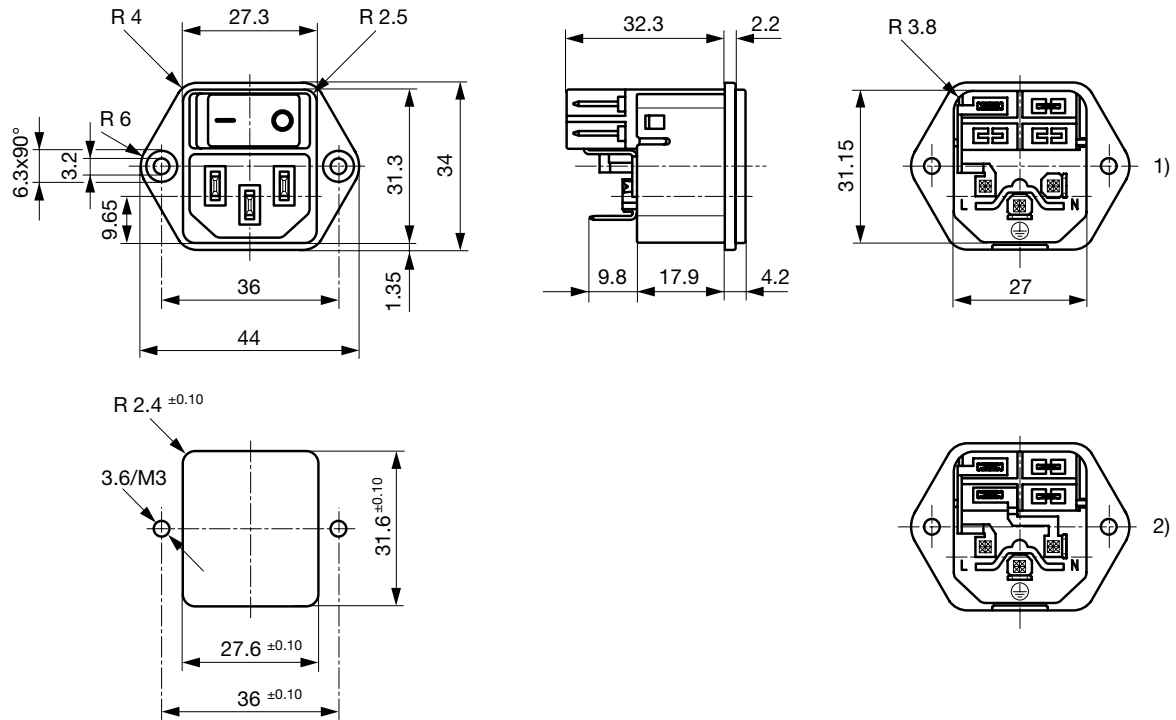

- 1) 1-pol non-illuminated
- 2) 2-pol illuminated, 2-pol non-illuminated

Snap-in mounting

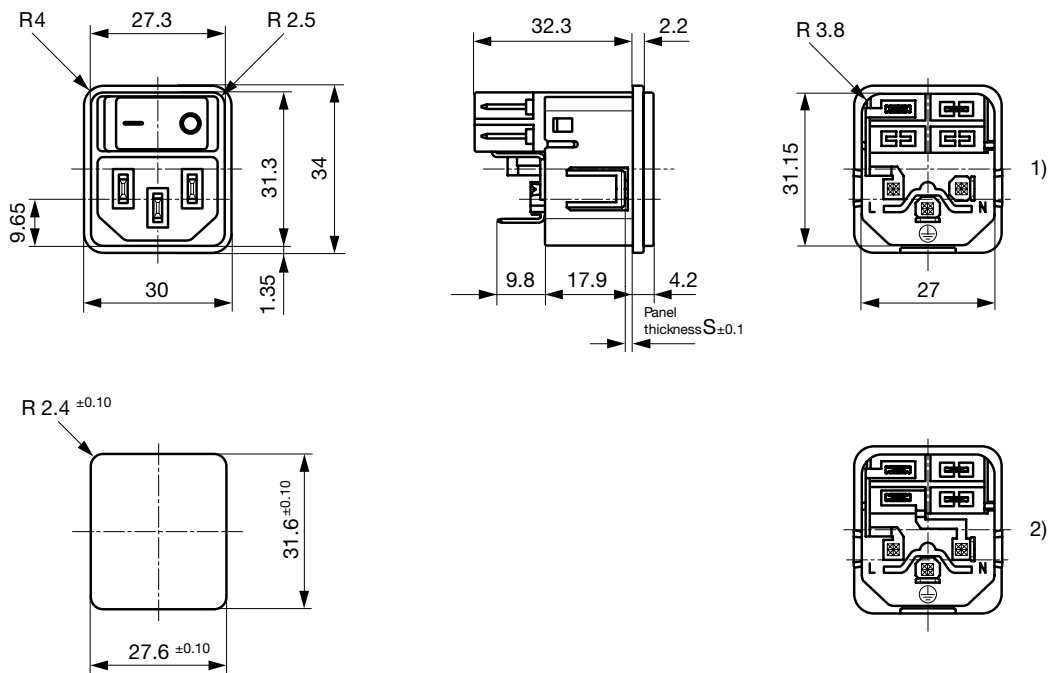

- 1) 1-pol non-illuminated
- 2) 2-pol illuminated, 2-pol non-illuminated

## Diagrams

Line switch non-illuminated 2-pole

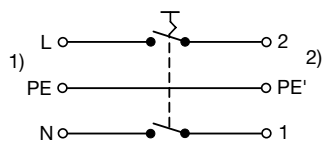

1) Line  
2) Load

Line switch illuminated 2-pole

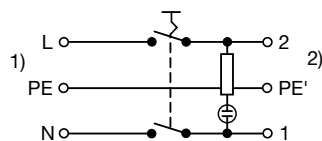

1) Line  
2) Load

Line switch non-illuminated 1-pole

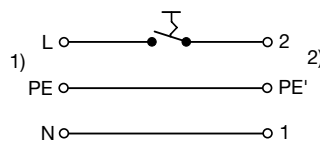

1) Line  
2) Load

## Variants

| Rated Current UL<br>[A] | Protection Class | Panel mounting | Panel Thickness s<br>[mm] | Line Switch | Illumination | Color | Order Number  |
|-------------------------|------------------|----------------|---------------------------|-------------|--------------|-------|---------------|
| 15                      | I                | Snap-in        | 1.5                       | 2-pole      | ●            | red   | DC11.0021.201 |
| 15                      | I                | Snap-in        | 1.5                       | 2-pole      | ●            | red   | DC11.0021.206 |
| 15                      | I                | Snap-in        | 2                         | 2-pole      | ●            | red   | DC11.0021.301 |
| 15                      | I                | Snap-in        | 2.5                       | 2-pole      | ●            | red   | DC11.0021.401 |
| 15                      | I                | Snap-in        | 1.5                       | 2-pole      | ●            | green | DC11.0031.201 |
| 15                      | I                | Snap-in        | 2                         | 2-pole      | ●            | green | DC11.0031.301 |
| 15                      | I                | Snap-in        | 2.5                       | 2-pole      | ●            | green | DC11.0031.401 |
| 15                      | I                | Snap-in        | 1.5                       | 1-pole      | -            | -     | DC11.0001.203 |
| 15                      | I                | Snap-in        | 1.5                       | 1-pole      | -            | -     | DC11.0001.207 |
| 15                      | I                | Snap-in        | 2                         | 1-pole      | -            | -     | DC11.0001.303 |
| 15                      | I                | Snap-in        | 2.5                       | 1-pole      | -            | -     | DC11.0001.403 |
| 15                      | I                | Snap-in        | 1.5                       | 2-pole      | -            | -     | DC11.0001.201 |
| 15                      | I                | Snap-in        | 1.5                       | 2-pole      | -            | -     | DC11.0001.206 |
| 15                      | I                | Snap-in        | 2                         | 2-pole      | -            | -     | DC11.0001.301 |
| 15                      | II               | Snap-in        | 2                         | 2-pole      | -            | -     | DC11.0001.351 |
| 15                      | I                | Snap-in        | 2.5                       | 2-pole      | -            | -     | 3-107-445     |
| 15                      | I                | Snap-in        | 2.5                       | 2-pole      | -            | -     | DC11.0001.401 |
| 15                      | I                | Snap-in        | 3                         | 2-pole      | -            | -     | DC11.0001.501 |
| 15                      | I                | Screw          | -                         | 2-pole      | ●            | red   | DC11.0021.001 |
| 15                      | I                | Screw          | -                         | 2-pole      | ●            | red   | DC11.0021.006 |
| 15                      | I                | Screw          | -                         | 2-pole      | ●            | green | DC11.0031.001 |
| 15                      | I                | Screw          | -                         | 1-pole      | -            | -     | DC11.0001.003 |
| 15                      | I                | Screw          | -                         | 1-pole      | -            | -     | DC11.0001.007 |
| 15                      | I                | Screw          | -                         | 2-pole      | -            | -     | DC11.0001.001 |
| 15                      | I                | Screw          | -                         | 2-pole      | -            | -     | DC11.0001.006 |

Availability for all products can be searched real-time: <https://www.schurter.com/en/info-center/support-tools/stock-check-distributors>

With screw mounting on PCB, 2 screws are included

All variants according VDE (ENEC 10) approved for 10 A

## Packaging unit

50 Pcs

Accessories

Description



[Wire\\_Harness](#)  
 Wire harness for SCHURTER products



[RC320](#)  
 Rear Cover for Power Entry Module



[Cord\\_retaining\\_kits](#)  
 Cord retaining strain relief

|                |           |
|----------------|-----------|
| Flat head, A   | 4700.0001 |
| Countersunk, B | 4700.0002 |

Mating Outlets/Connectors

Category / Description

[Appliance Outlet Overview complete](#)



|  |      |
|--|------|
| 4787, Mounting: Screw-on mounting, Appliance Outlet: IEC Solder terminals, 10 A, Suitable for appliances with protection class I     | 4787 |
| 4788, Mounting: Snap-in version, Appliance Outlet: IEC Solder / Quick Connect, 10 A, Suitable for appliances with protection class I | 4788 |
| IEC Appliance Outlet F or H, Screw-on Mounting, Front Side, Solder, PCB or Quick-connect Terminal                                    | 5091 |

[Connector Overview complete](#)



|   |         |
|---|---------|
| 4782 Mounting: Power Cord, 3 x 1 mm <sup>2</sup> / 3 x 18 AWG, Cable, Connector: IEC C13    | 4782    |
| 4785 Mounting: Power Cord, 3 x 1 mm <sup>2</sup> / 3 x 18 AWG, Cable, Connector: IEC C13    | 4785    |
| 4300-06 Mounting: Power Cord, 3 x 1 mm <sup>2</sup> / 3 x 18 AWG, Cable, Connector: IEC C13 | 4300-06 |
| 4781 Mounting: Power Cord, Cable, Connector: IEC C15  | 4781    |
| 4784 Mounting: Power Cord, 3 x 1 mm <sup>2</sup> / 3 x 18 AWG, Cable, Connector: IEC C15    | 4784    |

[Power Supply Cord Overview complete](#)



|   |           |
|---|-----------|
| Cord Sets 10 A, Europlug, 2.5 m, Connector IEC C13, H05VV-F3G1.0, black | 6004.0215 |
| Cord Sets 10 A, Europlug, 2.5 m, Connector IEC C13, H05VV-F3G1.0, black | 6003.0215 |

Mating Outlets/Connectors shuttered



[Connector Overview complete](#)

|  |      |
|--|------|
| 4783 Mounting: Power Cord, 3 x 1 mm <sup>2</sup> / 3 x 18 AWG, Cable, Connector: IEC C13 | 4783 |
|--|------|



[Power Cord Overview complete](#)

|   |         |
|---|---------|
| VAC13KS, Overview, V-Lock cord retaining, diverse Connector IEC C13, diverse, black         | VAC13KS |
| VAC17KS, V-Lock cord retaining, diverse m, Connector IEC C17, diverse, black / grey / white | VAC17KS |