



25W Single Output AC Dimmable LED Power Supply

PCD-25 series



■ Features :

- AC phase-cut dimming
- Work with leading edge and trailing edge TRIAC dimmers
- 115VAC or 230VAC models available
- Built-in active PFC function
- Constant current design
- Protections: Short circuit / Over temperature
- Cooling by free air convection
- Fully isolated plastic case
- IP42 design
- Class II power unit, no FG
- Class 2 power unit
- Suitable for LED related fixture or appliance (such as LED Decoration or Advertisement devices)
- 100% full load burn-in test
- Low cost
- High reliability
- 3 years warranty



■ GTIN CODE

MW Search: <https://www.meanwell.com/serviceGTIN.aspx>



PCD-25-350 A : With AC input 90~ 135VAC.
 B : With AC input 180~ 295VAC.

SPECIFICATION

MODEL	PCD-25-350 <input type="checkbox"/>	PCD-25-700 <input type="checkbox"/>	PCD-25-1050 <input type="checkbox"/>	PCD-25-1400 <input type="checkbox"/>	
OUTPUT	RATED CURRENT	350mA	700mA	1050mA	1400mA
	OPERATING VOLTAGE RANGE	40 ~ 58V	24 ~ 36V	16 ~ 24V	12 ~ 18V
	CURRENT ACCURACY	±5.0%			
	RATED POWER	20.3W	25.2W	25.2W	25.2W
	RIPPLE & NOISE (max.) Note.1	4.6Vp-p	2.7Vp-p	2.2Vp-p	2Vp-p
	NO LOAD OUTPUT VOLTAGE (max.)	60V	50V	35V	25V
SETUP TIME	500ms / 230VAC 2000ms / 115VAC at full load				
INPUT	FREQUENCY RANGE	47 ~ 63Hz			
	POWER FACTOR (Typ.)	PF>0.9/115VAC, PF>0.9/230VAC, PF>0.9/277VAC at full load (Please refer to "Power Factor Characteristic" curve)			
	TOTAL HARMONIC DISTORTION	A series	THD< 20% when output loading≥70% at 115VAC		
		B series	THD< 20% when output loading≥70% at 230VAC input and output loading≥80% at 277VAC input		
	EFFICIENCY (Typ.)	82%	81%	80.5%	81%
	AC CURRENT (Typ.)	0.6A/115VAC	0.3A/230VAC	0.2A/277VAC	
	INRUSH CURRENT(max.)	COLD START 10A(twidth=20μs measured at 50% Ipeak) at 115VAC / 230VAC			
	MAX. No. of PSUs on 16A CIRCUIT BREAKER	A series	37 units (circuit breaker of type B) / 37 units (circuit breaker of type C) at 115VAC		
	B series	80 units (circuit breaker of type B) / 80 units (circuit breaker of type C) at 230VAC			
LEAKAGE CURRENT	<0.5mA 120VAC / 240VAC				
PROTECTION	SHORT CIRCUIT	Hiccup mode, recovers automatically after fault condition is removed.			
	OVER TEMPERATURE	Shut down o/p voltage, re-power on to recover			
ENVIRONMENT	WORKING TEMP.	-30 ~ +60°C (Refer to "Derating Curve")			
	WORKING HUMIDITY	20 ~ 95% RH non-condensing			
	STORAGE TEMP., HUMIDITY	-40 ~ +80°C, 10 ~ 95% RH			
	TEMP. COEFFICIENT	±0.03%/°C (0 ~ 50°C)			
	VIBRATION	10 ~ 500Hz, 2G 12min./1cycle, period for 72min. each along X, Y, Z axes			
SAFETY & EMC	SAFETY STANDARDS	UL8750, CSA C22.2 No. 250.0-08, ENEC BS EN/EN61347.1, BS EN/EN61347-2-13, BS EN/EN62384(for B type only), BIS IS15885(for 350B,700B only), EAC TP TC 004,IP42 approved ; design refer to UL60950-1, BS EN/EN61347-1, BS EN/EN61347-2-13			
	WITHSTAND VOLTAGE	I/P-O/P:3.75KVAC			
	ISOLATION RESISTANCE	I/P-O/P:100M Ohms / 500VDC / 25°C/ 70% RH			
	EMC EMISSION	Compliance to BS EN/EN55015 (B type only), BS EN/EN61000-3-2 Class C ; BS EN/EN61000-3-3, FCC part 18 non-consumer equipment (A type only), EAC TP TC 020			
OTHERS	EMC IMMUNITY	Compliance to BS EN/EN61000-4-2,3,4,5,6,8,11, BS EN/EN55024,BS EN/EN61547, light industry level, EAC TP TC 020			
	MTBF	6612.9K hrs min. Telcordia SR-332 (Bellcore)	806.1Khrs min.	MIL-HDBK-217F (25°C)	
	DIMENSION	84*57*29.5mm (L*W*H)			
	PACKING	0.19Kg; 72pcs/14.7Kg/0.92CUFT			
NOTE	<ol style="list-style-type: none"> 1. Ripple & noise are measured at 20MHz of bandwidth by using a 12" twisted pair-wire terminated with a 0.1uf & 47uf parallel capacitor. 2. Direct connecting to LEDs is suggested, but is not suitable for using additional drivers. 3. To fulfill requirements of the latest ErP regulation for lighting fixtures, this LED power supply can only be used behind a switch without permanently connected to the mains. 4. The ambient temperature derating of 3.5°C/1000m with fanless models and of 5°C/1000m with fan models for operating altitude higher than 2000m(6500ft). 5. For any application note and IP water proof function installation caution, please refer our user manual before using. https://www.meanwell.com/Upload/PDF/LED_EN.pdf <p>※ Product Liability Disclaimer : For detailed information, please refer to https://www.meanwell.com/serviceDisclaimer.aspx</p>				

Mechanical Specification

Case No.PCD16A Unit:mm Tolerance:±1

A Type:(PCD-25_A)

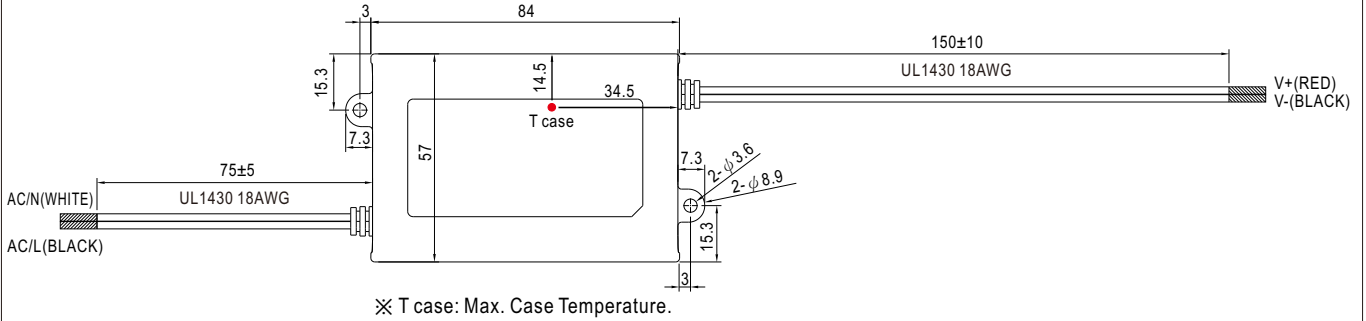

B Type:(PCD-25_B)

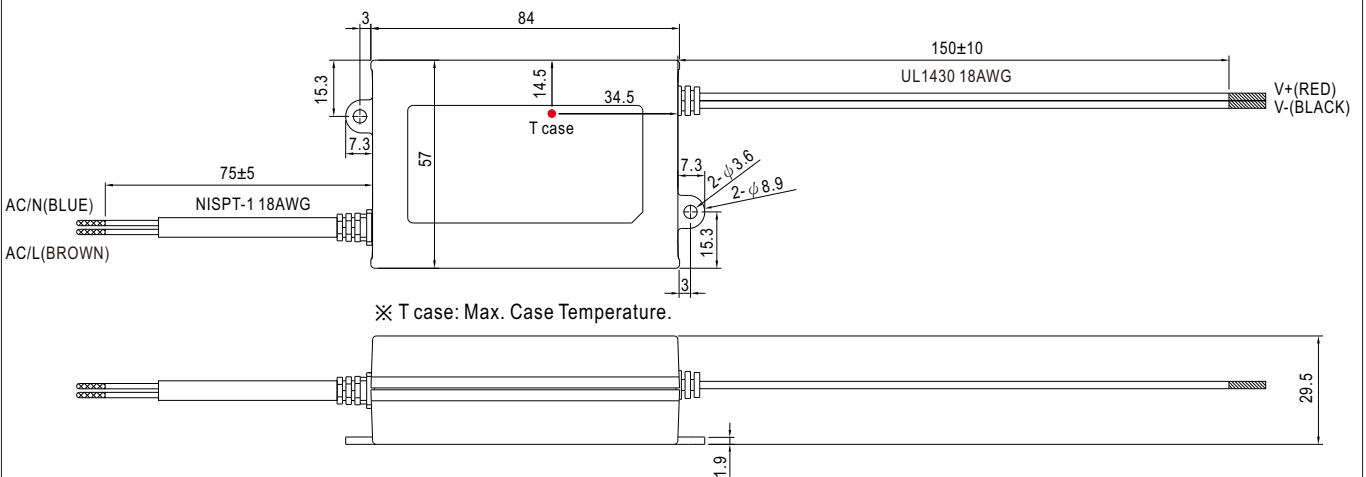

Block Diagram

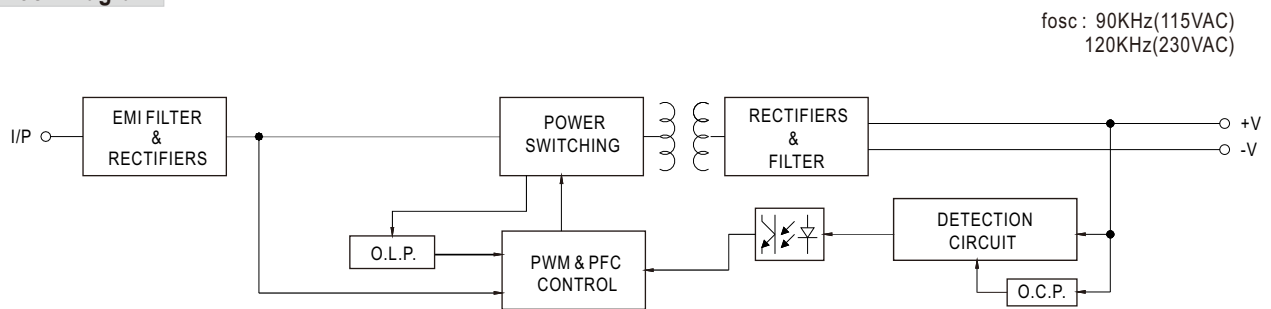

Derating Curve

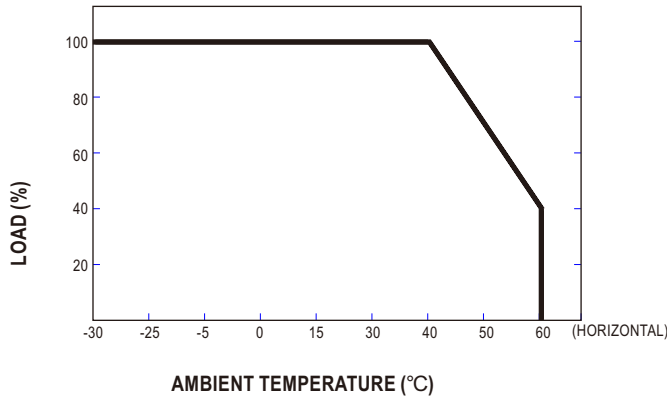

Static Characteristics

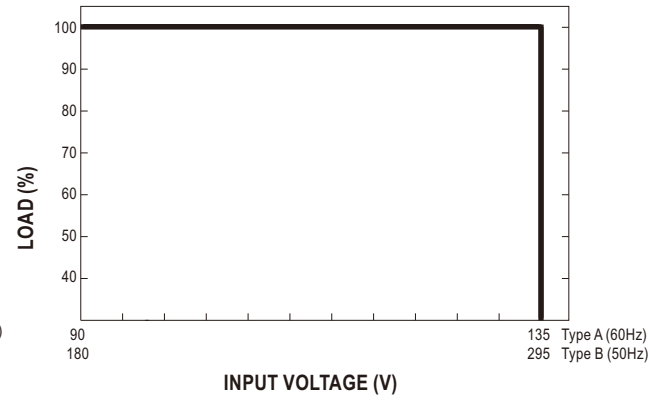

Power Factor Characteristic

Constant Current Mode

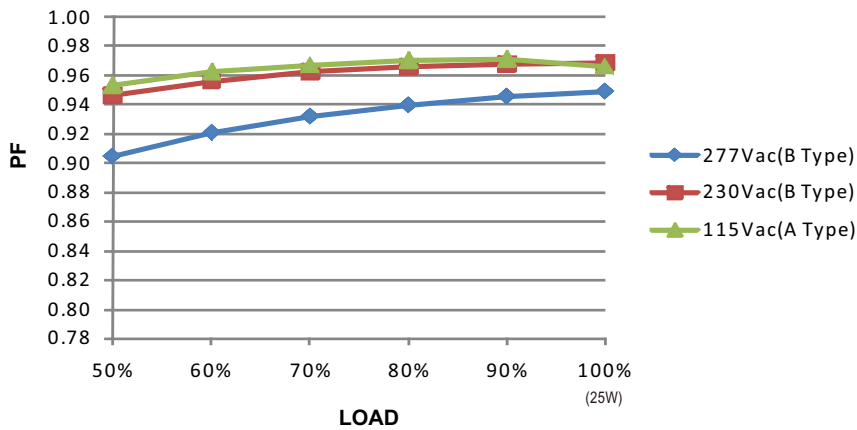

EFFICIENCY vs LOAD (PCD-25-350)

PCD-25 series possess superior working efficiency that up to 86% can be reached in field applications.

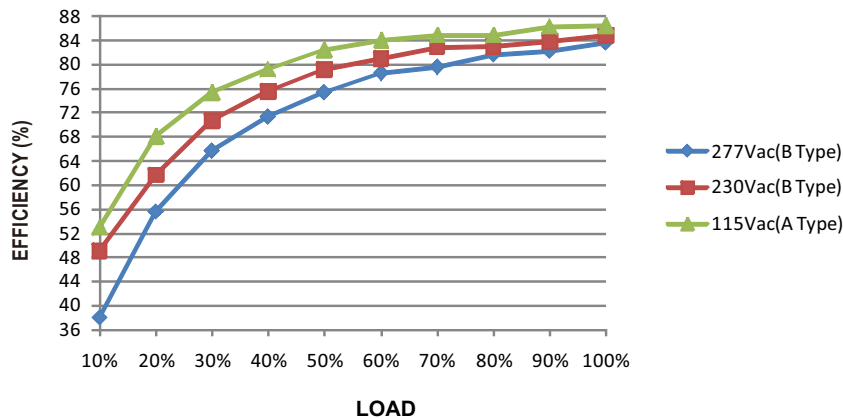

AC Dimming Operation

⊙ The following diagram depicts a typical installation utilizing the PCD-25 :

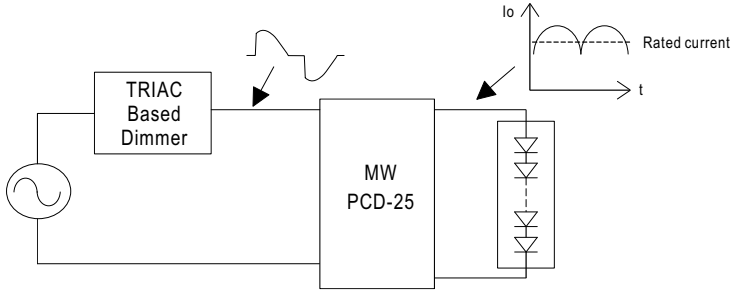

Under direct driving, the power supply will work in "constant current mode (CC)" and output voltage of the power supply will be clamped by sum of forward voltage (V_F) of the LED strip.

⊙ Dimmer Compatibility Chart

Manufacturer	Dimmer Model	
LUTRON	SKYLARK SF-12P-277	(277VAC / 60Hz)
LUTRON	DVF-103P-277	(277VAC / 60Hz)
LUTRON	SKYLARK SF-10P	(120VAC / 60Hz)
LUTRON	SKYLARK S-600P	(120VAC / 60Hz)
LUTRON	SKYLARK DVF-103P	(120VAC / 60Hz)
LEVITON	ILLUMATECH TM Cat.No.IP106	(120VAC / 60Hz)
LEVITON	SURESLIDE TM Cat.No.6633-P	(120VAC / 60Hz)
LEVITON	SURESLIDE TM Cat. NO.6615-P	(120VAC / 60Hz)
JUNG	Licht-Management 225 TDE	(230VAC / 50Hz)
JUNG	Licht-Management 225 NV DE	(230VAC / 50Hz)
BERKER	Tronic-Drehdimmer 286710	(230-240VAC / 50Hz)
Bodo Ehmann LICHTREGLER	T39.01	(230VAC / 50Hz)
CLIPSAL	32E450UDM	(220-240VAC / 50Hz)
CLIPSAL	NO 32E450TM	(220-240VAC / 50Hz)

Conduction angle: 30 degrees(min.) / 180 degrees(max.)