

Data Sheet | Item Number: 294-5002

Lighting connector; push-button, external; without ground contact; 2-pole; Lighting side: for solid conductors; Inst. side: for all conductor types; max. 2.5 mm²; Surrounding air temperature: max 85°C (T85); white



<https://www.wago.com/294-5002>



Color: ■ white

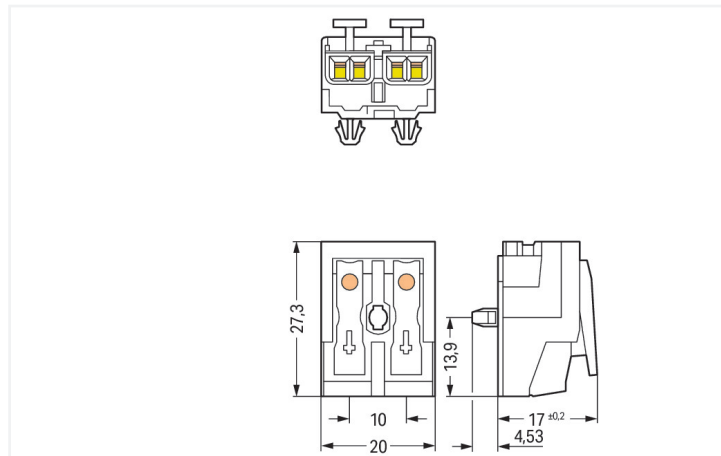

Dimensions in mm

Field-wiring terminal block, 294 Series, with 10 mm pin spacing

Connecting conductors is quick and easy with this field-wiring terminal block (item number 294-5002). Ensure that the strip lengths are between 8 and 9 mm when connecting conductors to this field-wiring terminal block. This product incorporates four conductor terminals and utilizes Push-in CAGE CLAMP® and PUSH WIRE®. Push-in CAGE CLAMP® connection technology is ideal for connecting all conductor types. It allows direct insertion of both solid and fine-stranded conductors with ferrules without needing to use any tools—all thanks to its pluggable design. Our proven PUSH WIRE® connection offers the fastest method for clamping conductors. It utilizes the conductor's stiffness to overcome the clamping spring's contact force. Dimensions: (20 x 21.53 x 27.3) mm (width x height x depth). This field-wiring terminal block is suitable for conductor cross sections ranging from 0.5 mm² to 2.5 mm² on one side and for conductor cross sections ranging from 0.5 mm² to 2.5 mm² on the other side as well as conductor cross sections from 0.5 mm² to 2.5 mm² and from 0.5 mm² to 0.75 mm² depending on the conductor type.

The contact surface is coated with tin.

Electrical data

Ratings per	IEC/EN 60998-1		
Overvoltage category	III	III	II
Pollution degree	3	2	2
Nominal voltage	-	-	500 V
Rated impulse withstand voltage	-	-	4 kV
Rated current	-	-	24 A

Ratings per IEC/EN – Notes

Ratings (note)	Connection points
----------------	-------------------

Ratings per	IEC/EN 60998-2-2		
Overvoltage category	III	III	II
Pollution degree	3	2	2
Nominal voltage	-	-	500 V
Rated impulse withstand voltage	-	-	4 kV
Rated current	-	-	24 A

General information

Wiring direction	Side-entry wiring
------------------	-------------------

Connection Data

Clamping units	10
Total number of potentials	2
Number of connection types	4
PE function	without PE contact

Connection 1

Connection type	External 1
Connection technology	Push-in CAGE CLAMP®
Number of connection points	2
Actuation type	Push-button
Connectable conductor materials	Copper
Solid conductor	0.5 ... 2.5 mm ² / 18 ... 12 AWG
Solid conductor; push-in termination	0.5 ... 2.5 mm ² / 18 ... 12 AWG
Stranded conductor	0.5 ... 2.5 mm ² / 18 ... 14 AWG
Fine-stranded conductor	0.5 ... 2.5 mm ² / 18 ... 14 AWG
Fine-stranded conductor; with insulated ferrule	0.5 ... 1.5 mm ² / 18 ... 16 AWG
Fine-stranded conductor; with uninsulated ferrule	0.5 ... 1.5 mm ² / 18 ... 16 AWG
Fine-stranded conductor; with ferrule; push-in termination	0.5 mm ² / 18 AWG
Strip length	8 ... 9 mm / 0.31 ... 0.35 inches
Pole number	2
Wiring direction	Side-entry wiring

Connection 2

Connection type	Internal 2
Connection technology	PUSH WIRE®
Number of connection points	1
Actuation type	Push-in
Solid conductor	0.5 ... 2.5 mm ² / 18 ... 14 AWG
Fine-stranded conductor; with insulated ferrule	0.5 ... 1 mm ² / 18 ... 16 AWG
Fine-stranded conductor; with uninsulated ferrule	0.5 ... 1.5 mm ² / 18 ... 14 AWG
Strip length	8 ... 9 mm / 0.31 ... 0.35 inches

Connection 3

Connection type	Internal 3
Connection technology	PUSH WIRE®
Number of connection points	1
Actuation type	Push-in
Solid conductor	0.5 ... 1.5 mm ² / 18 ... 16 AWG
Fine-stranded conductor; with insulated ferrule	0.5 ... 0.75 mm ² / 18 AWG
Fine-stranded conductor; with uninsulated ferrule	0.5 ... 1 mm ² / 18 AWG
Strip length	8 ... 9 mm / 0.31 ... 0.35 inches

Connection 4

Connection type	Internal 4
Connection technology	PUSH WIRE®
Number of connection points	1
Actuation type	Push-in
Solid conductor	0.5 ... 0.75 mm ² / 18 AWG
Strip length	8 ... 9 mm / 0.31 ... 0.35 inches

Physical data

Pin spacing	10 mm / 0.394 inches
Width	20 mm / 0.787 inches
Height	21.53 mm / 0.848 inches
Height from the surface	17 mm / 0.669 inches
Depth	27.3 mm / 1.075 inches

Mechanical data

Marking	plain
Mounting type	Snap-in foot

Material data

Note (material data)	Information on material specifications can be found here
Color	white
Material group	Illa
Insulation material (main housing)	Polycarbonate (PC)
Flammability class per UL94	V0
Clamping spring material	Chrome-nickel spring steel (CrNi)
Contact material	Electrolytic copper (E _{Cu})
Contact Plating	Tin
Fire load	0.094 MJ
Halogen-free	Yes
Weight	6.4 g

Environmental requirements

Temperature stability	120 °C
T marking	T85

Commercial data

Product Group	8 (Misc. Chassis Mount Blocks)
PU (SPU)	1000 pcs
Packaging type	Foil
Country of origin	CH
GTIN	4050821020738
Customs tariff number	85369010000

Product Classification

UNSPSC	39121402
eCl@ss 10.0	27-14-11-06
eCl@ss 9.0	27-14-11-06
ETIM 9.0	EC001284
ETIM 10.0	EC001284
ECCN	NO US CLASSIFICATION

Environmental Product Compliance

REACH Candidate List Substance	Perfluorobutane sulfonic acid (PFBS) and its salts
RoHS Compliance Status	Compliant, No Exemption
SCIP notification number (Austria)	28459bdf-28c1-4b35-9514-07ec04d1d63c
SCIP notification number (Belgium)	889f5262-ccf7-4759-a4bf-79b04ba4ba97
SCIP notification number (Bulgaria)	52566dfe-181c-47ea-a21b-d59e7bbba78e
SCIP notification number (Czech Republic)	2af161b6-3ed7-4804-b942-b3eb3b4cd421
SCIP notification number (Denmark)	863628a9-54a8-497d-8645-fc0b37237dc6
SCIP notification number (Finland)	1af51ecc-0a3d-430f-b134-63a7d79ad5ce
SCIP notification number (France)	776aac95-5d8d-479b-9903-a2d86f2077a9
SCIP notification number (Germany)	f39d0fad-c360-40d8-bf47-c73c0bc3d9d8
SCIP notification number (Hungary)	98783f74-802d-4731-998a-7df838268a20
SCIP notification number (Italy)	38101813-4156-4dcc-aed3-04321e163de7
SCIP notification number (Netherlands)	4e629cba-fa29-43d5-8992-57d23411391a
SCIP notification number (Poland)	73848426-b1d4-4f6d-9fa7-eb41335e6ac1

Environmental Product Compliance

SCIP notification number (Romania)	488d99bb-d4ac-494b-987c-4bd388c5d655
SCIP notification number (Sweden)	9274c736-27e3-4977-89cb-e8c1031d4347

Approvals / Certificates

General approvals **Declarations of conformity and manufacturer's declarations**



Approval	Standard	Certificate Name
ENEC 05 DEKRA Certification B.V.	EN 60998	2128791.01

Approval	Standard	Certificate Name
EU-Declaration of Confor- mity WAGO GmbH & Co. KG	-	-
UK-Declaration of Confor- mity WAGO GmbH & Co. KG	-	-

Downloads

Environmental Product Compliance

Compliance Search
Environmental Product Compliance 294-5002

Documentation

Bid Text			
294-5002	19.02.2019	xml 5.57 KB	
294-5002	13.06.2017	doc 27.00 KB	

CAD/CAE-Data

CAD data
2D/3D Models 294-5002

CAE data
WSCAD Universe 294-5002
ZUKEN Portal 294-5002

1 Compatible Products

1.1 Optional Accessories

1.1.1 Strain relief

1.1.1.1 Strain relief



Item No.: 294-370

Strain relief; for 294 Series; with snap-in mounting feet; white

Item No.: 294-375

Strain relief; for 294 Series; without snap-in mounting feet; white

1.1.1.2 Strain relief plate



Item No.: 294-364

Strain relief plate; for 294 Series; for multi-core cables; 3- to 5-pole; with secured clamp; white

Item No.: 294-384

Strain relief plate; for 294 Series; for single strands; 3- to 5-pole; with secured clamp; white

1.1.2 Tool

1.1.2.2 Operating tool



Item No.: 206-294

Disconnection tool; green

Installation Notes

Installation

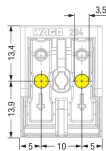

2-pole – without ground contact

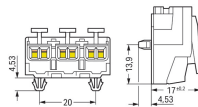

Snap-in foot

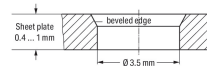

Drilled hole for snap-in mounting foot

Conductor termination

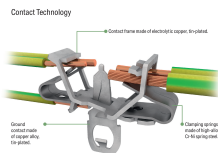

EUROPE	
1 x 0.5 ... 2.5 mm ² *s*	
1 x 0.5 ... 1.5 mm ² *s*	
1 x 0.5 ... 0.75 mm ² *s*	
AMERICA	
1 x AWG 18 ... 14 *s*	
1 x AWG 18 ... 16 *s*	
1 x AWG 18 *s*	
JAPAN	
1 x 0.8 ... 1.6 mm diam. *s*	
1 x 0.8 ... 1 mm diam. *s*	
1 x 0.8 mm diam. *s*	

EUROPE	
2 x 0.5 ... 2.5 mm ² *s, str, f-str*	
AMERICA	
2 x AWG 18 ... 12 *s*	
2 x AWG 18 ... 14 *s, f-str*	
JAPAN	
2 x 0.8 ... 2 mm diam. *s*	
2 x 0.5 ... 2 mm ² *str, f-str*	

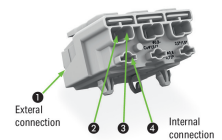

Internal connection:
PUSH WIRE® for internal wiring with solid conductors

External connection:
Push-in CAGE CLAMP® for field-wiring with all conductor types



Terminating five conductors per pole – solid and fine-stranded.

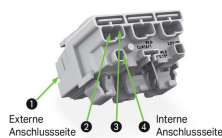

Externe Anschlussseite 1 2 3 4 Interne Anschlussseite

