

# POWER RELAY 1 POLE - 3A/5A, SLIM TYPE

## FTR-F3 Series

RoHS Compliant

### ■ FEATURES

- High density mounting  
Slim type with 7mm width and 142mm<sup>2</sup> mounting space
- High insulation  
Insulation distance: minimum 6mm between coil and contact  
Dielectric strength: 4,000V  
Surge strength: 10,000V
- Glow wire compliant type available which satisfies GWT required for relay in IEC/EN60335-1
- Cadmium free contact for eco-program
- Safety standards
- UL, CSA, VDE, CQC
- Plastic sealed relay, RTIII
- RoHS compliant



### ■ APPLICATIONS

Control of factory automation equipment, home appliances etc.

### ■ PART NUMBERS

[Example] FTR-F3 A A 012 E - HA - GW  
(a) (b) (c) (d) (e) (f) (g)

(a)	Relay type	FTR-F3 series
(b)	Contact configuration	A : 1a (1 Form A, SPST-NO)
(c)	Coil type (power)	A : 200mW
(d)	Coil rated voltage	012 : 5...24VDC Please refer to coil rating table
(e)	Contact material	E : AgNi
(f)	Contact rating	Nil : 3A type flux free HA : 5A type sealing confirmed KS : 5A type sealing confirmed
(g)	Special type	GW : Comply with GWEPT (IEC60695-2-11)

Actual marking does not carry the type name : "FTR"

E.g.: Ordering code: FTR-F3AA012E-HA Actual marking: F3AA012E

HT marking not part of type number printing but next to coil rating print.

## ■ SPECIFICATIONS

Item		Specifications		Remarks/Conditions	
		FTR-F3AA( )E	FTR-F3AA( )E-HA		
Contact Data	Configuration	1a (1 Form A, SPST)			
	Construction	Single			
	Material	AgNi			
	Resistance	Max. 100mΩ		Initial at 1A, 6VDC	
	Contact rating	3A, 125VAC/30VDC	5A, 250VAC/30VDC	Resistive	
	Max. carrying current	5A			
	Max. switching voltage	277VAC/30VDC			
	Max. switching power	750VA/90W	1,250VA/150W		
	Min. switching load *1	10mA, 5VDC			
Coil	Rated power (20°C)	200mW			
	Operate power	113mW			
	Operating temperature range	-40 °C to +70 °C		No frost	
Time	Operate	Max. 10ms		Without bounce, no diode	
	Release	Max. 10ms		Without bounce, no diode	
Life	Mechanical	Min. 5 x 10 <sup>6</sup> operations			
	Electrical	Min. 200 x 10 <sup>3</sup> operations	Min. 100 x 10 <sup>3</sup> operations	At rated load	
Insulation	Insulation resistance	Min. 1,000MΩ		At 500VDC	
	Dielectric strength	Open contacts	750VAC (50/60Hz) 1min		
		Coil to contacts	4,000VAC (50/60Hz) 1min		
	Surge strength	Coil to contacts	10,000V / 1.2 x 50μs standard wave		
	Clearance	6mm			
	Creepage	6mm			
	EN61810-1	Voltage	250V		
		Pollution	2		
Material group		III			
Others	Vibration resistance	Misoperation	10 to 55 to 10Hz single amplitude 0.75mm		Coil ON/OFF, 3 axis, total 6 cycles
		Endurance	10 to 55 to 10Hz single amplitude 0.75mm		Coil OFF, 3 axis, total 6 hours
	Shock resistance	Misoperation	Min. 100m/s <sup>2</sup> (11±1ms)		Coil ON/OFF, 3 axis, total 36 operations
		Endurance	Min. 1,000m/s <sup>2</sup> (6 ±1ms)		Coil OFF, 3 axis, total 18 operations
	Dimensions / Weight	7.0 x 20.3 x 15.0 mm / approx. 4g			
	Sealing	Plastic sealed RTIII			

\*1: Minimum switching loads mentioned above are reference values. Please perform the confirmation test with actual load before production since reference values may vary according to switching frequencies, environmental conditions

## ■ COIL DATA

Coil Code	Rated Coil Voltage (VDC)	Coil Resistance $\pm 10\%$ ( $\Omega$ )	Must Operate Voltage (VDC)	Must Release Voltage (VDC)	Rated Power (mW)
005	5	125	3.75	0.5	200
006	6	180	4.5	0.6	
009	9	405	6.75	0.9	
012	12	720	9	1.2	
018	18	1,620	13.5	1.8	
024	24	2,880	18	2.4	

Note 1: All values given in the coil table(s) are valid at 20°C ambient temperature, at zero contact current, without pre-energizing and are specified at pulse wave voltage.

Note 2: When applying a higher than rated coil voltage, please refer to the "coil temperature rise" and "operating range". Reference graphs for the effects on the relay operating behaviour.

## ■ SAFETY STANDARDS

Type	Compliance	Contact Rating	
		FTR-F3AA( )E	FTR-F3AA( )E-HA
UL	Flammability: UL 94-V-0 (plastics)		
	UL60947-1, UL60947-4-1 File No. E63614	[Certified part number: FTR-F3AA( )E] 5A, 277VAC/30VDC (resistive) 6A, 277VAC (resistive) 3A, 277VAC/30VDC (resistive)	[Certified part number: FTR-F3AA( )E] 3A, 277VAC/30VDC (resistive) 6A, 277VAC (resistive) 5A, 277VAC/277VAC (resistive)
CSA	C22.2 No. 14 File No. LR 40304	1/10 HP, 125VAC 1/8 HP, 277VAC Pilot duty: D300	1/10 HP, 250VAC (UL only), 1/10HP 125VAC 1/8 HP, 277VAC Pilot duty: D300
VDE	IEC/EN61810-1	3A, 250VAC, $\cos\phi = 1$ 3A, 30VDC, L/R=0ms	5A, 250VAC, $\cos\phi = 1$ 5A, 30VDC, L/R=0ms
CQC	GB/T21711.1, GB4943.1; IEC61810-1 File No. 10002049449, 04001010925, 17002164382	3A, 250VAC/30VDC 5A (except-KS, -GW type)	5A 250VAC/30VDC

The part numbers on the safety standards' certifications and the ordering part numbers may differ. Coil code is in ( ).

## ■ PART NUMBER LIST

Part Number	Contact Configuration	Rated Power	Contact Material	Contact rating	Special type
FTR-F3AA( )E	1a (1 Form A)	Approx. 200mW	AgNi	3A, 125VAC/30VDC	-
FTR-F3AA( )E-KS					Plastic seal
FTR-F3AA( )E-GW					Comply with GWEPT
FTR-F3AA( )E-KS-GW					Plastic seal, comply with GWEPT
FTR-F3AA( )E-HA	1a (1 Form A)	Approx. 200mW	AgNi	5A, 250VAC/30VDC	-
FTR-F3AA( )E-HA-GW					Comply with GWEPT

+ Please contact us for -GW.

## ■ DIMENSIONS

Dimensions

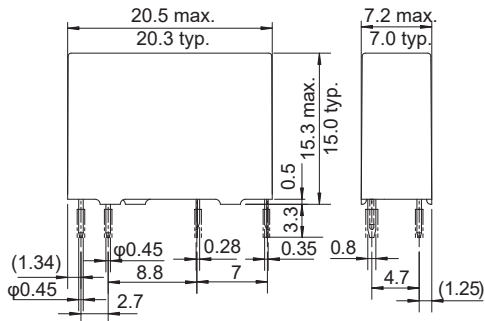

Schematics  
(BOTTOM VIEW)

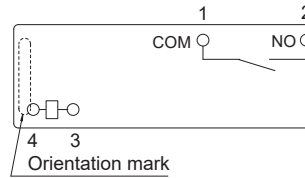

PC board mounting hole layout  
(BOTTOM VIEW)

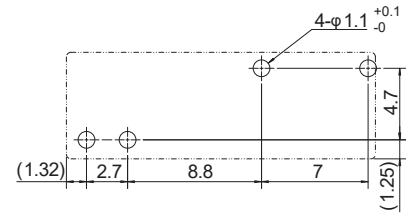

- Dimensions of the terminals do not include thickness of pre-soldering.
- Tolerance of PC board mounting hole layout :  $\pm 0.1$  unless otherwise specified.

Unit: mm  
( ) : Reference

## CHARACTERISTIC DATA

(Characteristic data is not guaranteed value but measured values of samples from production line.)

### Coil temperature rise

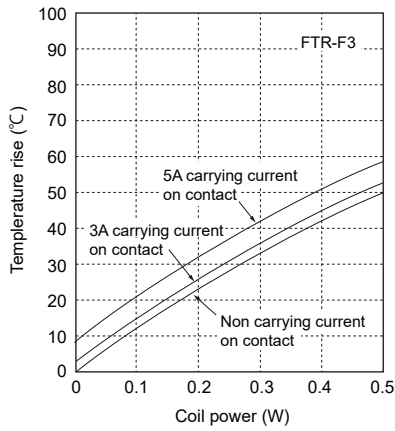

### Operating range

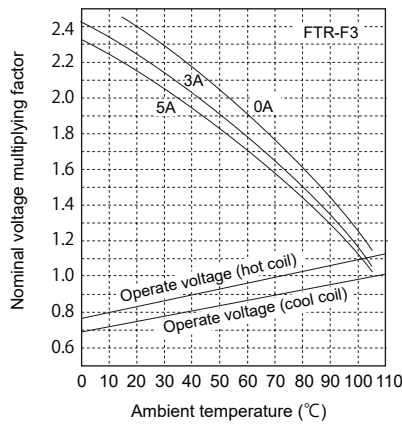

### Maximum switching power

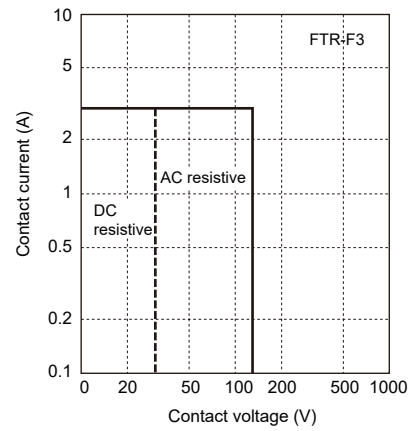

### Maximum switching power

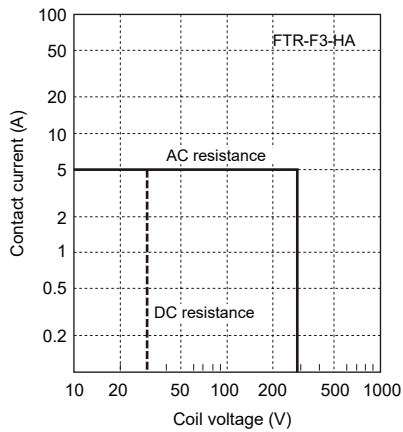

### Life curve - 3A type

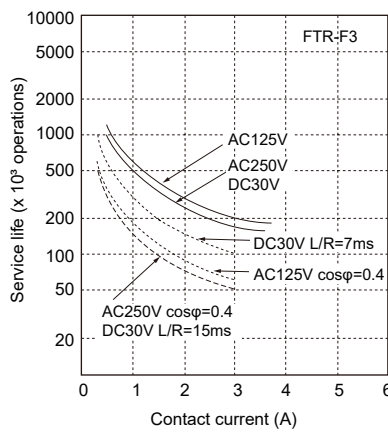

### Life curve - 5A type

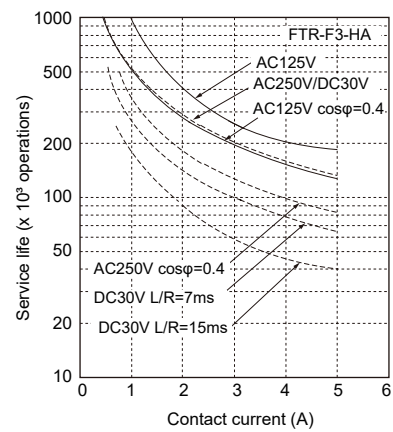

### Distribution of operate/release voltage

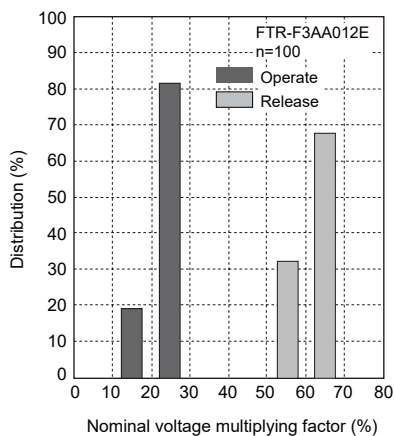

### Distribution of contact resistance

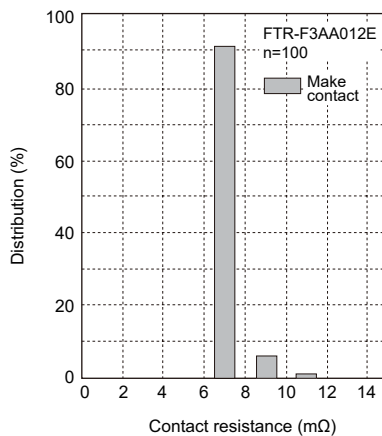

## CAUTIONS

- All values mentioned in this datasheet are provided under ideal conditions. Please perform the confirmation test before actual use.
- Reflow soldering is prohibited.
- Do not use relays in the atmosphere with sulfide gas, chloride gas or nitric oxide. Contact resistance may increase.
- Do not use silicon or silicon-containing product or materials near relays. It may cause contact failure.

## GENERAL INFORMATION

### 1. ROHS Compliance

- All relays produced by FCL Components are compliant with RoHS directive 2011/65/EU, including commission delegated directive 2015/863.

### 2. Recommended lead free solder condition

- Lead free solder plating on relay terminals is Sn-3.0Ag-0.5Cu, unless otherwise specified. This material has been verified to be compatible with PbSn assembly process.
- Recommended solder for assembly: Sn-3.0Ag-0.5Cu.

#### Flow Solder Condition:

Pre-Heating: Maximum 120°C within 90 sec.

Soldering: Dip within 5 sec. at 255°C±5°C solder bath

Relay must be cooled by air immediately after soldering

#### Solder by Soldering Iron:

Soldering Iron: 30-60W

Temperature: Maximum 340-360°C

Duration: Maximum 3 sec.

**We highly recommend that you confirm your actual solder conditions**

### 3. Moisture Sensitivity

- Moisture Sensitivity Level standard is not applicable to electromechanical relays, unless otherwise indicated.

### 4. Tin Whiskers

- Dipped SnAgCu solder is known as presenting a low risk to tin whisker development. No considerable length whisker was found by our in-house test.

## Contact

### Japan

FCL COMPONENTS LIMITED  
Shinagawa Seaside Park Tower  
12-4, Higashi-shinagawa 4-chome,  
Tokyo 140 0002, Japan  
Tel: +81-3-3450-1682  
Email: fcl-contact@cs.fcl-components.com

### North and South America

FCL COMPONENTS AMERICA, INC.  
2055 Gateway Place Suite 480,  
San Jose, CA 95110 USA  
Tel: +1-408-745-4900  
Email: contact@fcl-components.us

### Europe

FCL COMPONENTS EUROPE B.V.  
Diamantlaan 25  
2132 WV Hoofddorp, Netherlands  
Tel: +31-23-556-0910  
Email: info@fcl-components.eu

### Asia Pacific

FCL COMPONENTS ASIA PTE LTD.  
51 Changi Business Park Central 2, #06-07  
The Signature Singapore 486066  
Tel: +65-6375-8560  
Email: fcal@fcl-components.com

### China

FCL COMPONENTS (SHANGHAI) CO.,LTD.  
Unit 1105, Central Park - Jing An,  
No.329 Heng Feng Road, Shanghai  
200070, China  
Tel: +86-21-3253 0998  
Email: fcsh@fcl-components.com

### Hong Kong

FCL COMPONENTS HONG KONG CO.,  
LIMITED  
Unit 2313, Seapower Tower, Concordia  
Plaza, No.1 Science Museum Road,  
TST, Kowloon, Hong Kong  
Tel: +852-2881-8495  
Email: fcal@fcl-components.com

Web: [www.fcl-components.com/en/](http://www.fcl-components.com/en/)

---

© 2026 FCL Components Limited. All rights reserved. All trademarks or registered trademarks are the property of their respective owners.

FCL Components Products are intended for general use, including without limitation, in personal, household and office environments, in buildings and for ordinary use in the industry. FCL Components Products are not intended to be used in applications where extremely high safety is required ("High Safety Required Applications"), such as, but not limited to, applications in nuclear facilities, in aircraft automatic flight control, in air traffic control, in mass transit system control, in missile launch system, in weapon systems, in medical equipment for life support or any application involving a direct serious risk of physical injury or death.

Please do not use FCL Components Products without securing the sufficient safety and reliability required for the High Safety Required Applications.

In addition, FCL Components shall not be liable against the customer and/or any third party for any claims or damages arising in connection with the use of FCL Components Products in the High Safety Required Applications.

FCL Components warrants that its Products, if properly used and services, will conform to their specification and will be free from defects in material and workmanship for twelve months from delivery.

The implied warranties of merchantability and fitness for a particular purpose and all other warranties, representations and conditions, express or implied by statute, trade usage or otherwise, except as set forth in this warranty, are excluded and shall not apply to the Products delivered.

The contents, data and information in this datasheet are provided by FCL Components Limited as a service only to its user and only for general information purposes. The use of the contents, data and information provided in this datasheet is at the users' own risk.

FCL Components has assembled this datasheet with care and will endeavor to keep the contents, data and information correct, accurate, comprehensive, complete and up to date.

FCL Components Limited and affiliated companies do however not accept any responsibility or liability on their behalf, nor on behalf of its employees, for any loss or damage, direct, indirect or consequential, with respect to this datasheet, its contents, data, and information and related graphics and the correctness, reliability, accuracy, comprehensiveness, usefulness, availability and completeness thereof. Nor do FCL Components Limited and affiliated companies accept on their behalf, nor on behalf of its employees, any responsibility or liability with respect to these datasheets, its contents, data, information and related graphics and the correctness, reliability, accuracy, comprehensiveness, usefulness, availability and completeness thereof. Rev. March 10, 2026.