

Data Sheet | Item Number: 2010-1305

3-conductor through terminal block; 10 mm²; suitable for Ex e II applications; side and center marking; for DIN-rail 35 x 15 and 35 x 7.5; Push-in CAGE CLAMP®; 10,00 mm²; black

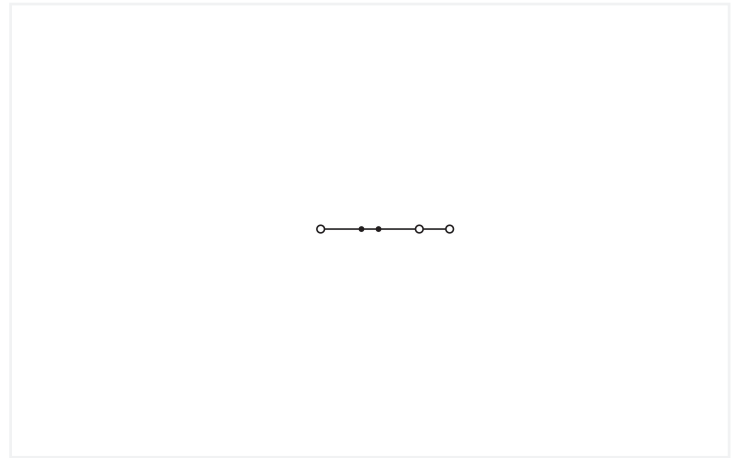

<https://www.wago.com/2010-1305>

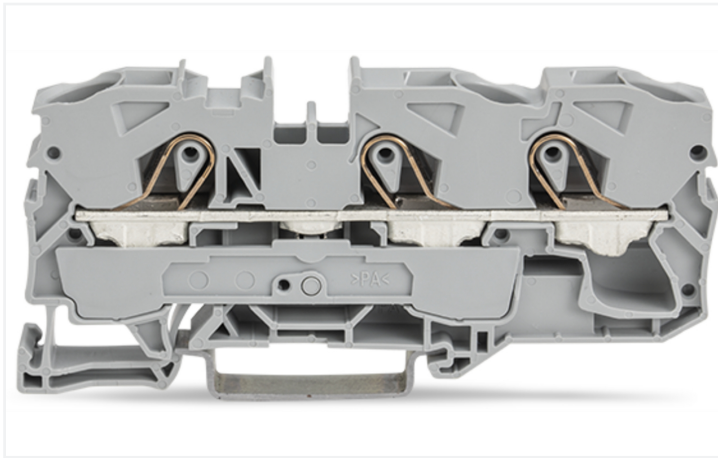

Color: ■ black

Similar to illustration

Similar to illustration

Through terminal block, 2010 Series, operating tool

Our through terminal block (item number 2010-1305) is the perfect way to connect conductors quickly and easily. Ensure that the strip lengths are between 17 and 19 mm when connecting conductors to this through terminal block. Whether in industrial or building applications, our rail-mount through terminal blocks are the perfect solution to quickly and securely connect electrical conductors. Depending on the version, you can use them for either typical through-wiring or potential distribution. This product features conductor terminals and utilizes Push-in CAGE CLAMP®. Our Push-in CAGE CLAMP® is a universal, maintenance-free connection solution for all conductor types, boasting a key feature: both solid and fine-stranded conductors with ferrules can be directly inserted without the need for tools or any preparation, such as crimping the ferrule. The item's dimensions are (10 x 89 x 43.5) mm (width x height x depth). This through terminal block is suitable for conductor cross sections ranging from 0.5 mm² to 16 mm².

An operating tool is used to operate this through rail-mount terminal block. Our TOPJOB® S rail-mount terminal blocks guarantee secure electrical connections in different industrial applications and modern building installations. They make wiring work easier as you can quickly plug in solid, stranded, and fine-stranded conductors with ferrules. This product is designed for specific Ex applications (please refer to the product datasheet).

Electrical data

Ratings per	IEC/EN 60947-7-1		
Overvoltage category	III	III	II
Pollution degree	3	2	2
Nominal voltage	800 V	-	-
Rated impulse withstand voltage	8 kV	-	-
Rated current	57 A	-	-
Current at conductor cross-section (max.) mm ²	76 A	-	-

Approvals per	UL 1059		
Use group	B	C	D
Rated voltage	600 V	600 V	-
Rated current	65 A	65 A	-

Approvals per	CSA 22.2 No 158		
Use group	B	C	D
Rated voltage	600 V	600 V	-
Rated current	65 A	65 A	-

Ex information	
Reference to hazardous areas	See application instructions in section "Knowledge and Downloads – Documentation – Additional Information: Technical Section; Technical Explanations"
Ratings per	ATEX: PTB 05 ATEX 1070 U / IECEx: PTB 06.0003U (Ex eb IIC Gb)

Ex information

Rated voltage EN (Ex e II)	550 V
Rated current (Ex e II)	50 A

Power Loss

Power loss, per pole (potential)	1.8194 W
Rated current I_N for power loss specification	57 A
Resistance value for specified, current-dependent power loss	0.00056 Ω

General information

Wiring direction	Front-entry wiring
------------------	--------------------

Connection Data

Clamping units	3
Total number of potentials	1
Number of levels	1
Number of jumper slots	2

Connection 1

Connection technology	Push-in CAGE CLAMP®
Actuation type	Operating tool
Connectable conductor materials	Copper
Nominal cross-section	10 mm ²
Solid conductor	0.5 ... 16 mm ² / 20 ... 6 AWG
Solid conductor; push-in termination	4 ... 16 mm ² / 14 ... 6 AWG
Fine-stranded conductor	0.5 ... 16 mm ² / 20 ... 6 AWG
Fine-stranded conductor; with insulated ferrule	0.5 ... 10 mm ² / 20 ... 8 AWG
Fine-stranded conductor; with ferrule; push-in termination	4 ... 10 mm ² / 12 ... 8 AWG
Note (conductor cross-section)	Depending on the conductor characteristic, a conductor with a smaller cross-section can also be inserted via push-in termination. AWG specifications were converted according to IEC.
Strip length	17 ... 19 mm / 0.67 ... 0.75 inches
Wiring direction	Front-entry wiring

Physical data

Width	10 mm / 0.394 inches
Height	89 mm / 3.504 inches
Depth from upper-edge of DIN-rail	36.9 mm / 1.453 inches
Depth	43.5 mm / 1.713 inches

Mechanical data

Mounting type	DIN-35 rail
Marking level	Center/side marking

Material data

Note (material data)	Information on material specifications can be found here
Color	black
Material group	I
Insulation material (main housing)	Polyamide (PA66)
Flammability class per UL94	V0
Fire load	0.344 MJ
Weight	23.3 g

Environmental requirements

Processing temperature	-35 ... +85 °C
Continuous operating temperature	-60 ... +105 °C

Environmental Testing

Test specification: Railway applications – Rolling stock – Electronic equipment	DIN EN 50155 (VDE 0115-200):2022-06
Test procedure: Railway applications – Rolling stock equipment – Vibration and shock tests	DIN EN 61373 (VDE 0115-0106):2011-04
Spectrum/Mounting location	Service life test, Category 1, Class A/B
Functional test with noise-like oscillations	Test passed according to Section 8 of the standard
Frequency	$f_1 = 5 \text{ Hz}$ to $f_2 = 150 \text{ Hz}$
Acceleration	0.101g (highest test level used for all axes)
Test duration per axis	10 min.
Test directions	X, Y and Z axes
Monitoring of contact faults and interruptions	Passed
Voltage drop measurement before and after each axis	Passed
Simulated service life test through increased levels of noise-like oscillations	Test passed according to Section 9 of the standard
Frequency	$f_1 = 5 \text{ Hz}$ to $f_2 = 150 \text{ Hz}$
Acceleration	0.572g (highest test level used for all axes)
Test duration per axis	5 h
Test directions	X, Y and Z axes
Extended testing: Monitoring of contact faults and interruptions	Passed
Extended testing: Voltage drop measurement before and after each axis	Passed
Shock test	Test passed according to Section 10 of the standard
Shock pulse form	Half sine
Acceleration	5g (highest test level used for all axes)
Shock duration	30 ms
Number of shocks (per axis)	3 pos. und 3 neg.
Test directions	X, Y and Z axes
Extended testing: Monitoring of contact faults and interruptions	Passed
Extended testing: Voltage drop measurement before and after each axis	Passed
Vibration and shock stress for rolling stock equipment	Passed

Commercial data

PU (SPU)	25 pcs
Packaging type	Box
Country of origin	DE
GTIN	4055143645881
Customs tariff number	85369010000

Product Classification

UNSPSC	39121410
eCl@ss 10.0	27-14-11-20
eCl@ss 9.0	27-14-11-20
ETIM 9.0	EC000897
ETIM 10.0	EC000897
ECCN	NO US CLASSIFICATION

Environmental Product Compliance

RoHS Compliance Status	Compliant, No Exemption
------------------------	-------------------------

Approvals / Certificates

General approvals



Approval	Standard	Certificate Name
CCA DEKRA Certification B.V.	EN 60947	NTR NL 7876
CSA DEKRA Certification B.V.	C22.2 No. 158	70111238
KEMA/KEUR DEKRA Certification B.V.	EN 60947	71-119201
UL UL International Germany GmbH	UL 1059	E45172

Declarations of conformity and manufacturer's declarations



Approval	Standard	Certificate Name
ATEX-Attestation of Conformity WAGO GmbH & Co. KG	-	-
EU-Declaration of Conformity WAGO GmbH & Co. KG	-	-
Railway WAGO GmbH & Co. KG	-	Railway Ready
UK-Declaration of Conformity WAGO GmbH & Co. KG	-	-

Approvals for marine applications



Approval	Standard	Certificate Name
ABS American Bureau of Shipping	-	24-0152298-PDA
DNV GL Det Norske Veritas, Germanischer Lloyd	-	TAE00001V2
PRS Polski Rejestr Statków	-	TE/1094/880590/23

Approvals for hazardous areas



Approval	Standard	Certificate Name
AEx UL International Germany GmbH c/o Physikalisch Technische Bundesanstalt	UL 60079	E185892 (Ex e II)
ATEX Physikalisch Technische Bundesanstalt (PTB)	EN 60079	PTB 05 ATEX 1070 U (II 2 G Ex eb II C bzw. I M 2 Ex eb I Mb)
CCC CNEX	GB/T 3836.3	2020312313000161 (Ex eb IIC Gb, Ex eb I Mb)
IECEx Physikalisch Technische Bundesanstalt (PTB)	IEC 60079	IECEx PTB 06.0003 U (Ex eb IIC Gb and Ex ebl Mb)
INMETRO TÜV Rheinland do Brasil Ltda.	IEC 60079	TÜV 12.1311 U

Downloads

Environmental Product Compliance

Compliance Search

Environmental Product Compliance 2010-1305



CAD/CAE-Data

CAD data

2D/3D Models
2010-1305



CAE data

EPLAN Data Portal
2010-1305



ZUKEN Portal
2010-1305



1 Compatible Products

1.1 Required Accessories

1.1.1 End plate

1.1.1.1 End plate



Item No.: 2010-1391

End and intermediate plate; 1 mm thick; gray



Item No.: 2010-1392

End and intermediate plate; 1 mm thick; orange



Item No.: 209-191

Separator for Ex e/Ex i applications; 3 mm thick; 120 mm wide; orange

1.2 Optional Accessories

1.2.1 Cover

1.2.1.1 Cover



Item No.: 2010-100

Finger guard; touchproof cover protects unused conductor entries; yellow

1.2.2 DIN-rail

1.2.2.1 Mounting accessories



Item No.: 210-196

Aluminum carrier rail; 35 x 8.2 mm; 1.6 mm thick; 2 m long; unslotted; similar to EN 60715; silver-colored



Item No.: 210-198

Copper carrier rail; 35 x 15 mm; 2.3 mm thick; 2 m long; unslotted; according to EN 60715; copper-colored



Item No.: 210-197

Steel carrier rail; 35 x 15 mm; 1.5 mm thick; 2 m long; slotted; similar to EN 60715; silver-colored



Item No.: 210-114

Steel carrier rail; 35 x 15 mm; 1.5 mm thick; 2 m long; unslotted; similar to EN 60715; silver-colored



Item No.: 210-118

Steel carrier rail; 35 x 15 mm; 2.3 mm thick; 2 m long; unslotted; according to EN 60715; silver-colored



Item No.: 210-113

Steel carrier rail; 35 x 7.5 mm; 1 mm thick; 2 m long; unslotted; according to EN 60715; silver-colored

1.2.3 Ferrule

1.2.3.1 Ferrule



Item No.: 216-284

Ferrule; Sleeve for 1.5 mm² / AWG 16; insulated; electro-tin plated; electrolytic copper; gastight crimped; acc. to DIN 46228, Part 4/09.90; black

Item No.: 216-289

Ferrule; Sleeve for 10 mm² / AWG 8; insulated; electro-tin plated; electrolytic copper; gastight crimped; acc. to DIN 46228, Part 4/09.90; red

Item No.: 216-286

Ferrule; Sleeve for 2.5 mm² / AWG 14; insulated; electro-tin plated; electrolytic copper; gastight crimped; acc. to DIN 46228, Part 4/09.90; blue

Item No.: 216-287

Ferrule; Sleeve for 4 mm² / AWG 12; insulated; electro-tin plated; electrolytic copper; gastight crimped; acc. to DIN 46228, Part 4/09.90; gray



Item No.: 216-288

Ferrule; Sleeve for 6 mm² / AWG 10; insulated; electro-tin plated; electrolytic copper; gastight crimped; acc. to DIN 46228, Part 4/09.90; yellow

1.2.4 Installation

1.2.4.1 Cover



Item No.: 709-156

Cover; Type 3; suitable for cover carrier, type 3; 1 m long; transparent

1.2.4.2 Cover carrier



Item No.: 709-169

Cover carrier; Type 3; incl. fixing/retaining screws and knurled nut; suitable for 279 to 282 and 880 Series rail-mounted terminal blocks; suitable for 264 Series miniature rail-mounted terminal blocks; suitable for 270 Series sensor and actuator terminal blocks; gray

1.2.5 Jumper

1.2.5.1 Jumper



Item No.: 2010-402

Jumper; 2-way; insulated; light gray



Item No.: 2010-403

Jumper; 3-way; insulated; light gray



Item No.: 2010-404

Jumper; 4-way; insulated; light gray



Item No.: 2010-405

Jumper; 5-way; insulated; light gray



Item No.: 2010-433

Jumper; from 1 to 3; insulated; light gray



Item No.: 2010-434

Jumper; from 1 to 4; insulated; light gray



Item No.: 2010-435

Jumper; from 1 to 5; insulated; light gray



Item No.: 2010-405/011-000

Star point jumper; 3-way; insulated; light gray



Item No.: 2016-499

Step-down jumper; from 2016/2010 to 2010/2006/2004/2002 series; from 2216/2210 to 2210/2206/2204/2202 series; insulated; light gray



Item No.: 285-430

Step-down jumper; from 285 (35mm²) to 2016/2010 series; insulated; gray

1.2.6 Marking

1.2.6.1 Group marker carrier



Item No.: [2009-191](#)

Group marker carrier; gray

Item No.: [2009-192](#)

Group marker carrier; gray

Item No.: [2009-193](#)

Group marker carrier; gray

1.2.6.2 Marker

Item No.: [2009-145/000-006](#)

Mini-WSB Inline; for Smart Printer; 1700 pieces on roll; stretchable 5 - 5.2 mm; plain; snap-on type; blue

Item No.: [2009-145/000-007](#)

Mini-WSB Inline; for Smart Printer; 1700 pieces on roll; stretchable 5 - 5.2 mm; plain; snap-on type; gray

Item No.: [2009-145/000-023](#)

Mini-WSB Inline; for Smart Printer; 1700 pieces on roll; stretchable 5 - 5.2 mm; plain; snap-on type; green

Item No.: [2009-145/000-012](#)

Mini-WSB Inline; for Smart Printer; 1700 pieces on roll; stretchable 5 - 5.2 mm; plain; snap-on type; orange

Item No.: [2009-145/000-005](#)

Mini-WSB Inline; for Smart Printer; 1700 pieces on roll; stretchable 5 - 5.2 mm; plain; snap-on type; red

Item No.: [2009-145/000-024](#)

Mini-WSB Inline; for Smart Printer; 1700 pieces on roll; stretchable 5 - 5.2 mm; plain; snap-on type; violet

Item No.: [2009-145](#)

Mini-WSB Inline; for Smart Printer; 1700 pieces on roll; stretchable 5 - 5.2 mm; plain; snap-on type; white

Item No.: [2009-145/000-002](#)

Mini-WSB Inline; for Smart Printer; 1700 pieces on roll; stretchable 5 - 5.2 mm; plain; snap-on type; yellow



Item No.: [248-501/000-006](#)

Mini-WSB marking card; as card; not stretchable; plain; snap-on type; blue

Item No.: [248-501/000-007](#)

Mini-WSB marking card; as card; not stretchable; plain; snap-on type; gray

Item No.: [248-501/000-023](#)

Mini-WSB marking card; as card; not stretchable; plain; snap-on type; green

Item No.: [248-501/000-017](#)

Mini-WSB marking card; as card; not stretchable; plain; snap-on type; light green



Item No.: [248-501/000-012](#)

Mini-WSB marking card; as card; not stretchable; plain; snap-on type; orange

Item No.: [248-501/000-005](#)

Mini-WSB marking card; as card; not stretchable; plain; snap-on type; red

Item No.: [248-501/000-024](#)

Mini-WSB marking card; as card; not stretchable; plain; snap-on type; violet

Item No.: [248-501](#)

Mini-WSB marking card; as card; not stretchable; plain; snap-on type; white



Item No.: [248-501/000-002](#)

Mini-WSB marking card; as card; not stretchable; plain; snap-on type; yellow

Item No.: [793-5501/000-006](#)

WMB marking card; as card; for terminal block width 5 - 17.5 mm; stretchable 5 - 5.2 mm; plain; snap-on type; blue

Item No.: [793-5501/000-007](#)

WMB marking card; as card; for terminal block width 5 - 17.5 mm; stretchable 5 - 5.2 mm; plain; snap-on type; gray

Item No.: [793-5501/000-023](#)

WMB marking card; as card; for terminal block width 5 - 17.5 mm; stretchable 5 - 5.2 mm; plain; snap-on type; green



Item No.: [793-5501/000-017](#)

WMB marking card; as card; for terminal block width 5 - 17.5 mm; stretchable 5 - 5.2 mm; plain; snap-on type; light green

Item No.: [793-5501/000-012](#)

WMB marking card; as card; for terminal block width 5 - 17.5 mm; stretchable 5 - 5.2 mm; plain; snap-on type; orange

Item No.: [793-5501/000-005](#)

WMB marking card; as card; for terminal block width 5 - 17.5 mm; stretchable 5 - 5.2 mm; plain; snap-on type; red

Item No.: [793-5501/000-024](#)

WMB marking card; as card; for terminal block width 5 - 17.5 mm; stretchable 5 - 5.2 mm; plain; snap-on type; violet



Item No.: [793-5501](#)

WMB marking card; as card; for terminal block width 5 - 17.5 mm; stretchable 5 - 5.2 mm; plain; snap-on type; white

Item No.: [793-5501/000-002](#)

WMB marking card; as card; for terminal block width 5 - 17.5 mm; stretchable 5 - 5.2 mm; plain; snap-on type; yellow

Item No.: [793-501/000-006](#)

WMB marking card; as card; not stretchable; plain; snap-on type; blue

Item No.: [793-501/000-007](#)

WMB marking card; as card; not stretchable; plain; snap-on type; gray



Item No.: [793-501/000-023](#)

WMB marking card; as card; not stretchable; plain; snap-on type; green

Item No.: [793-501/000-017](#)

WMB marking card; as card; not stretchable; plain; snap-on type; light green

Item No.: [793-501/000-012](#)

WMB marking card; as card; not stretchable; plain; snap-on type; orange

Item No.: [793-501/000-005](#)

WMB marking card; as card; not stretchable; plain; snap-on type; red



Item No.: [793-501/000-024](#)

WMB marking card; as card; not stretchable; plain; snap-on type; violet

Item No.: [793-501](#)

WMB marking card; as card; not stretchable; plain; snap-on type; white

Item No.: [793-501/000-002](#)

WMB marking card; as card; not stretchable; plain; snap-on type; yellow

Item No.: [2009-115/000-006](#)

WMB-Inline; for Smart Printer; 1500 pieces on roll; stretchable 5 - 5.2 mm; plain; snap-on type; blue



Item No.: [2009-115/000-007](#)

WMB-Inline; for Smart Printer; 1500 pieces on roll; stretchable 5 - 5.2 mm; plain; snap-on type; gray

Item No.: [2009-115/000-023](#)

WMB-Inline; for Smart Printer; 1500 pieces on roll; stretchable 5 - 5.2 mm; plain; snap-on type; green

Item No.: [2009-115/000-017](#)

WMB-Inline; for Smart Printer; 1500 pieces on roll; stretchable 5 - 5.2 mm; plain; snap-on type; light green

Item No.: [2009-115/000-012](#)

WMB-Inline; for Smart Printer; 1500 pieces on roll; stretchable 5 - 5.2 mm; plain; snap-on type; orange

1.2.6.2 Marker



Item No.: 2009-115/000-024

WMB-Inline; for Smart Printer; 1500 pieces on roll; stretchable 5 - 5.2 mm; plain; snap-on type; violet



Item No.: 2009-115

WMB-Inline; for Smart Printer; 1500 pieces on roll; stretchable 5 - 5.2 mm; plain; snap-on type; white



Item No.: 2009-115/000-002

WMB-Inline; for Smart Printer; 1500 pieces on roll; stretchable 5 - 5.2 mm; plain; snap-on type; yellow

1.2.6.3 Marker carrier



Item No.: 2009-198

Adaptor; gray

1.2.6.4 Marking strip



Item No.: 2009-110

Marking strips; for Smart Printer; on reel; not stretchable; plain; snap-on type; white

1.2.7 Protective warning marker

1.2.7.1 Cover



Item No.: 2010-115

Protective warning marker; for 5 terminal blocks; with high-voltage symbol, black; yellow

1.2.8 Screwless end stop

1.2.8.1 Mounting accessories



Item No.: 249-117

Screwless end stop; 10 mm wide; for DIN-rail 35 x 15 and 35 x 7.5; gray



Item No.: 249-116

Screwless end stop; 6 mm wide; for DIN-rail 35 x 15 and 35 x 7.5; gray

1.2.9 Test and measurement

1.2.9.1 Testing accessories



Item No.: 2010-511

Modular TOPJOB®S connector; modular; for jumper contact slot; 1-pole; gray



Item No.: 2010-549

Spacer module; modular; e.g., for bridging commoned terminal blocks; gray



Item No.: 2009-174

Test plug adapter; for 4 mm Ø test plugs; for testing TOPJOB®S rail-mounted terminal blocks; gray



Item No.: 2009-182

Testing tap; for max. 2.5 mm²; tool-free connection for individual test wires 0.08 - 2.5 mm; gray

1.2.10 Tool

1.2.10.1 Operating tool



Item No.: 210-721

Operating tool; Blade: 5.5 x 0.8 mm; with a partially insulated shaft; multicoloured

Installation Notes

Conductor termination



All conductor types at a glance

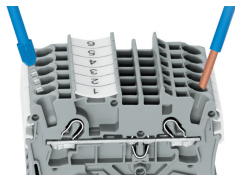

Push-in termination of solid and ferruled conductors

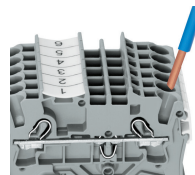

Inserting a conductor via push-in termination:

Solid conductors with cross-sections from either one size above, or up to two sizes below, the rated cross-section can be simply pushed in – no tools needed.

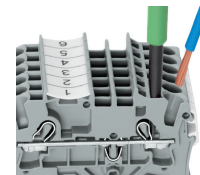

Inserting a conductor via operating tool:

Connecting fine-stranded conductors without ferrules, or small cross-sectional conductors that cannot be pushed in, is performed similarly to the original CAGE CLAMP® – just use an operating tool.

Advantage:

To open the clamp, the operating tool is inserted vertically. The conductor entry is less than 15 degrees for easier wiring.

Commoning

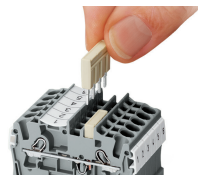

Insert push-in type jumper bar and push down until it hits backstop.

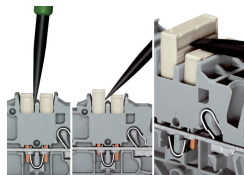

Removing a push-in type jumper bar:

Insert the operating tool between the jumper and partition wall of the dual jumper slots, then lift up the jumper.

Place the operating tool in the center of jumpers for up to five contacts (see above), or alternately on both sides for jumpers with more than five contacts.

Commoning

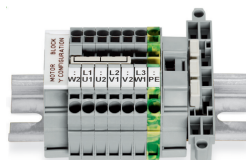

This star point jumper has been specially developed to create a "star point" and is used on motor terminal boards equipped with Rail-Mount Terminal Blocks TOPJOB® S.

Commoning

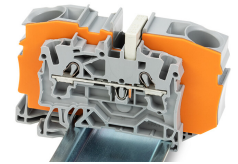
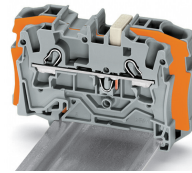
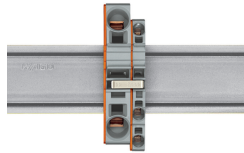
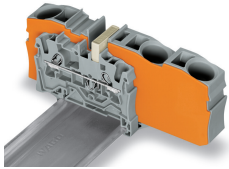

Step-down jumpers common terminal blocks of different sizes, without losing a conductor clamping point. This can be beneficial on long conductor runs where voltage drop can be a problem. A large conductor can be easily connected to smaller conductors at the distribution point. Commoning may be made in either direction using the special thin end plate to cover the open side. Additional through terminal blocks having a smaller cross-section may be commoned using push-in type jumper bars.

Using step-down jumpers, an end plate must be inserted between the terminal blocks to be commoned.

Step-down jumper (Item No. 2006-499) commons 6/4 mm² (10/12 AWG) terminal blocks (2006/2004 Series) with 4/2.5/1.5 mm² (AWG 12/14/16) terminal blocks (2004/2002/2001 Series).

Step-down jumper (Item No. 2016-499) commons 16/10 mm² (16/8 AWG) terminal blocks (2016/2010 Series) with 10/6/4/2.5 mm² (8/10/12/14 AWG) terminal blocks (2010/2006/2004/2002 Series).

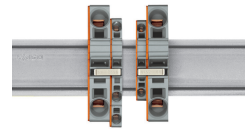
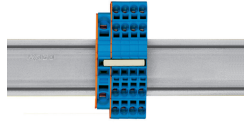
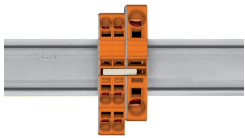

Stepping down via push-in type jumper bar: Commoning via open terminal side with end plate allows jumpering over two cross-section sizes for 16 mm² (6 AWG) and 10 mm² (8 AWG) and one cross-section size for 6/4/2.5 mm² (10/12/14 AWG). An example: from 16 mm² (6 AWG) to 6 mm² (10 AWG) (see illustration above) or from 10 mm² (8 AWG) to 4 mm² (12 AWG).

Stepping down via push-in type jumper bar: Commoning via closed terminal side with end plate allows jumpering over two cross-section sizes, e.g., from 16 mm² (6 AWG) to 6 mm² (10 AWG) or from 6 mm² (10 AWG) to 2.5 mm² (14 AWG) (see illustration above).

Note: The total current of the outgoing circuits must not exceed the nominal current of the step-down jumper/push-in type jumper bar.

Testing

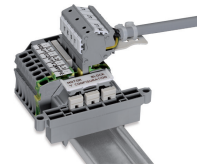
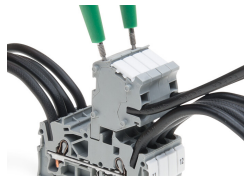
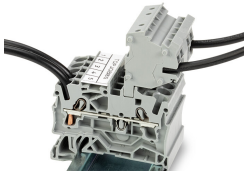

The modular TOPJOB® S connectors also connect conductors of the same size as the terminal blocks being used.

TOPJOB® S Connectors with a 2 mm Ø test socket for testing voltage via 2-pole voltage tester

Rail-mount terminal block assembly for electric motor wiring

Test plug adapter (Item No. 2009-174, CAT I) for 4 mm Ø plugs – compatible with 2000 to 2016 Series

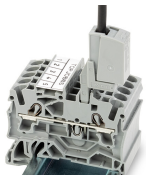

Testing tap (Item No. 2009-182) for tool-free connection of test cables up to 2.5 mm² (12 AWG) – compatible with 2000 to 2016 Series

Marking

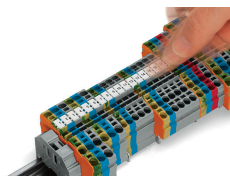

Snapping WMB Inline markers into marker slots.

TOPJOB® S 2009-193 Group Marker Carrier (equipped with a marking strip) for all 2001 to 2016 Series TOPJOB® S Rail-Mount Terminal Blocks
Do not use on an end plate!

Ex application

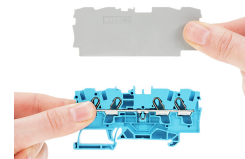
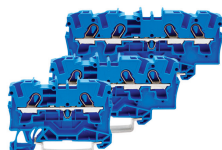
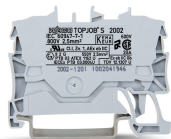

Through terminal blocks with a blue insulated housing are suitable for Ex i applications.

All through and ground conductor terminal blocks are suitable for Ex e II applications.

Separator plate for Ex e/Ex i applications

An end plate must be applied to the terminal block located directly behind an Ex e/Ex i separator plate.

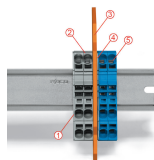

Ex e II/Ex i terminal strip

Note:
The movable feet of terminal blocks and separator plates must face the same direction.

A separator plate is located between the Ex e II and Ex i terminal strip.

End plate
Ex e II terminal blocks
Separator plate for Ex e/Ex i applications
End plate

Ex i terminal blocks
According to EN 50020, a minimum distance of 50 mm must be kept between live parts of Ex e and Ex i circuits. The use of Ex e/Ex i separators is a space-saving solution when Ex e and Ex i terminal blocks are mounted on a common DIN-rail.