

**RCL425024****Weidmüller Interface GmbH & Co. KG**

Klingenbergstraße 26

D-32758 Detmold

Germany

[www.weidmueller.com](http://www.weidmueller.com)**Product image**

Similar to illustration

Individual relays for TERMSERIES

- Electromechanical relays
- Different contact materials

**General ordering data**

Version	TERMSERIES, Relay, Number of contacts: 2, CO contact AgNi gold-plated, Rated control voltage: 24 V DC, Continuous current: 8 A, Plug-in connection, Test button available: No
Order No.	<a href="#">4058580000</a>
Type	RCL425024
GTIN (EAN)	4032248269129
Qty.	20 items

RCL425024

Weidmüller Interface GmbH &amp; Co. KG

Klingenbergstraße 26

D-32758 Detmold

Germany

www.weidmueller.com

## Technical data

## Approvals

Approvals



ROHS Conform

UL File Number Search [UL Website](#)

Certificate No. (cURus) E522350

## Dimensions and weights

Depth	15.7 mm	Depth (inches)	0.6181 inch
Height	29 mm	Height (inches)	1.1417 inch
Width	12.7 mm	Width (inches)	0.5 inch
Net weight	12.32 g		

## Temperatures

Storage temperature	-40 °C...85 °C	Ambient temperature	-40 °C...70 °C
Operating temperature		Humidity	40 °C / 93 % rel. humidity, no condensation

## Environmental Product Compliance

RoHS Compliance Status	Compliant without exemption
REACH SVHC	No SVHC above 0.1 wt%

## Rated data UL

Certificate No. (cURus)	E522350
-------------------------	---------

## Control side

Rated control voltage	24 V DC	Rated current DC	16.7 mA
Power rating	400 mW	Coil resistance	1440 Ω ± 10 %
Status indicator	No		

## Load side

Rated switching voltage	250 V AC	Continuous current	8 A
Max. switching frequency at rated load	0.1 Hz	Inrush current	15 A / 4 s
AC switching capacity (resistive), max.	2000 VA	DC switching capacity (resistive), max.	192 W @ 24 V
Switch-on delay	≤ 8 ms	Switch-off delay	≤ 6 ms
Contact type	2 CO contact (AgNi gold-plated)	Mechanical service life	30 x 106 switching cycles
Min. switching power	1 mA @ 1 V		

## General data

Test button available	No	Mechanical switch position indicator	No
Colour	Transparent	UL 94 flammability rating	V-2

## Insulation coordination

Rated voltage	250 V	Pollution severity	2
Surge voltage category	III	Insulating material group	IIIa

Creation date 18.02.2026 08:30:29 MEZ

Catalogue status / Drawings

## RCL425024

**Weidmüller Interface GmbH & Co. KG**  
 Klingenbergstraße 26  
 D-32758 Detmold  
 Germany

www.weidmueller.com

## Technical data

Clearance and creepage distances for control side - load side	≥ 10 mm	Dielectric strength for control side - load side	5 kVeff / 1min
Dielectric strength of neighbouring contacts	2.5 kVeff / 1 Min.	Dielectric strength of open contact	1 kVeff / 1 min
Protection degree	IP20		

### Further details of approvals / standards

Certificate No. (CSA)	249409-2426937	Certificate No. (VDE)	40020589
Certificate No. (cURus)	E522350		

### Connection data

Wire connection method	Plug-in connection	Pitch in mm (P)	5.00 mm
------------------------	--------------------	-----------------	---------

### Classifications

ETIM 8.0	EC001437	ETIM 9.0	EC001437
ETIM 10.0	EC001437	ECLASS 14.0	27-37-16-01
ECLASS 15.0	27-37-16-01		

**Drawings**

**Wiring diagram**



View of Pins from below

**Graph**

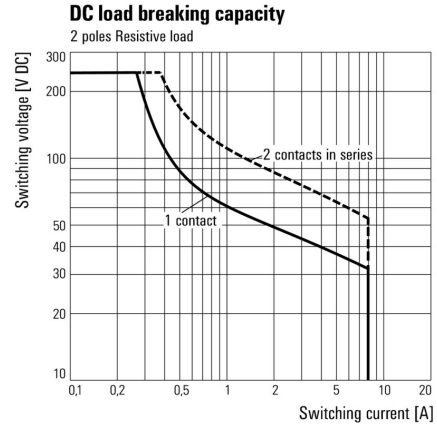

DC load limit curve Resistive load

**Graph**



Electrical service life 250 V AC resistive load



Miscellaneous

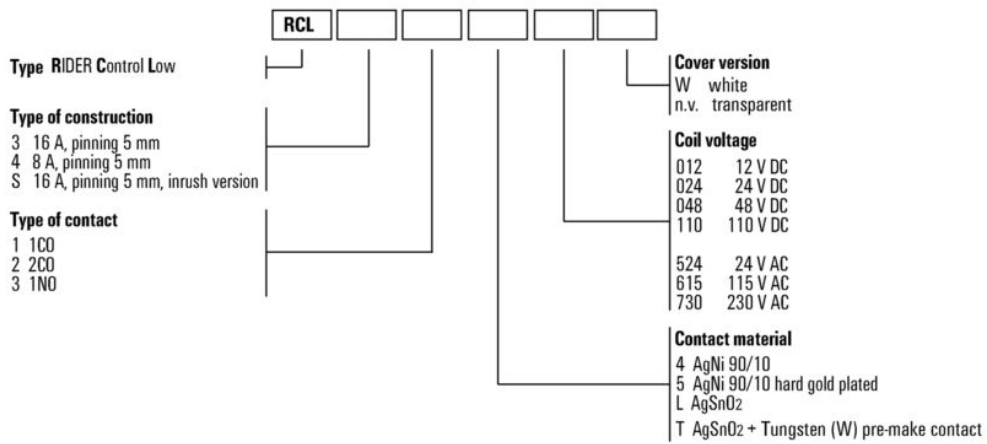

Type codes

## RCL425024

Weidmüller Interface GmbH &amp; Co. KG

Klingenbergstraße 26

D-32758 Detmold

Germany

www.weidmueller.com

## Accessories

## Screw connection



TERMSERIES empty sockets with:

- 2 CO contacts
- Unique multi-voltage input from 24 to 230 V UC
- Input voltages from 5 V DC to 230 V UC with coloured marking: AC: red, DC: blue, UC: white
- Due to high-quality design and no sharp edges no risk of injuries during installation
- Partition plates for optical separation and reinforcement of insulation

## General ordering data

Type	TRS 24VDC 2CO EMPTY	Version	
Order No.	<a href="#">1123980000</a>	TERMSERIES, Relay socket, Number of contacts: 2, CO contact, Rated control voltage: 24 V DC $\pm$ 20 %, Continuous current: 10 A, Screw connection	
GTIN (EAN)	4032248905997		
Qty.	10 ST		

## Tension clamp connection

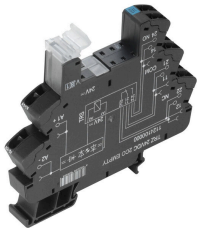

TERMSERIES empty sockets with:

- 2 CO contacts
- Unique multi-voltage input from 24 to 230 V UC
- Input voltages from 5 V DC to 230 V UC with coloured marking: AC: red, DC: blue, UC: white
- Due to high-quality design and no sharp edges no risk of injuries during installation
- Partition plates for optical separation and reinforcement of insulation

## General ordering data

Type	TRZ 24VDC 2CO EMPTY	Version	
Order No.	<a href="#">1124100000</a>	TERMSERIES, Relay socket, Number of contacts: 2, CO contact, Rated control voltage: 24 V DC $\pm$ 20 %, Continuous current: 10 A, Tension-clamp connection	
GTIN (EAN)	4032248906048		
Qty.	10 ST		

## PUSH IN connection

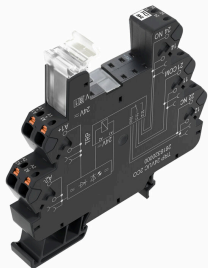

TERMSERIES empty sockets with:

- 2 CO contacts
- Unique multi-voltage input from 24 to 230 V UC
- Input voltages from 5 V DC to 230 V UC with coloured marking: AC: red, DC: blue, UC: white
- Due to high-quality design and no sharp edges no risk of injuries during installation
- Partition plates for optical separation and reinforcement of insulation

## General ordering data

Type	TRP 24VDC 2CO EMPTY	Version	
Order No.	<a href="#">2680970000</a>	TERMSERIES, Relay socket, Number of contacts: 2, CO contact, Rated control voltage: 24 V DC $\pm$ 20 %, Continuous current: 10 A, PUSH IN	
GTIN (EAN)	4050118695175		
Qty.	10 ST		

## RCL425024

Weidmüller Interface GmbH &amp; Co. KG

Klingenbergstraße 26

D-32758 Detmold

Germany

www.weidmueller.com

## Accessories

## Screw connection

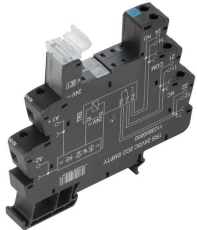

TERMSERIES empty sockets with:

- 2 CO contacts
- Unique multi-voltage input from 24 to 230 V UC
- Input voltages from 5 V DC to 230 V UC with coloured marking: AC: red, DC: blue, UC: white
- Due to high-quality design and no sharp edges no risk of injuries during installation
- Partition plates for optical separation and reinforcement of insulation

## General ordering data

Type	TRS 24VUC 2CO EMPTY	Version	
Order No.	<a href="#">1123990000</a>	TERMSERIES, Relay socket, Number of contacts: 2, CO contact, Rated	
GTIN (EAN)	4032248905805	control voltage: 24 V UC $\pm 10\%$ , Continuous current: 10 A, Screw	
Qty.	10 ST	connection	

## Tension clamp connection

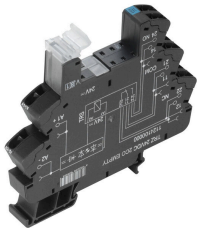

TERMSERIES empty sockets with:

- 2 CO contacts
- Unique multi-voltage input from 24 to 230 V UC
- Input voltages from 5 V DC to 230 V UC with coloured marking: AC: red, DC: blue, UC: white
- Due to high-quality design and no sharp edges no risk of injuries during installation
- Partition plates for optical separation and reinforcement of insulation

## General ordering data

Type	TRZ 24VUC 2CO EMPTY	Version	
Order No.	<a href="#">1124110000</a>	TERMSERIES, Relay socket, Number of contacts: 2, CO contact, Rated	
GTIN (EAN)	4032248906031	control voltage: 24 V UC $\pm 10\%$ , Continuous current: 10 A, Tension-	
Qty.	10 ST	clamp connection	

## PUSH IN connection

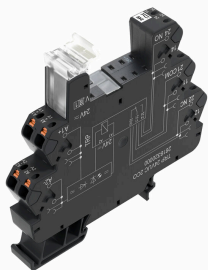

TERMSERIES empty sockets with:

- 2 CO contacts
- Unique multi-voltage input from 24 to 230 V UC
- Input voltages from 5 V DC to 230 V UC with coloured marking: AC: red, DC: blue, UC: white
- Due to high-quality design and no sharp edges no risk of injuries during installation
- Partition plates for optical separation and reinforcement of insulation

## General ordering data

Type	TRP 24VUC 2CO EMPTY	Version	
Order No.	<a href="#">2680980000</a>	TERMSERIES, Relay socket, Number of contacts: 2, CO contact, Rated	
GTIN (EAN)	4050118695182	control voltage: 24 V UC $\pm 10\%$ , Continuous current: 10 A, PUSH IN	
Qty.	10 ST		

## RCL425024

Weidmüller Interface GmbH &amp; Co. KG

Klingenbergstraße 26

D-32758 Detmold

Germany

www.weidmueller.com

## Accessories

## Screw connection

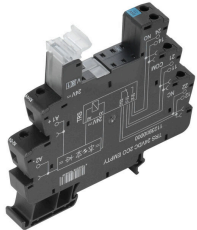

TERMSERIES empty sockets with:

- 2 CO contacts
- Unique multi-voltage input from 24 to 230 V UC
- Input voltages from 5 V DC to 230 V UC with coloured marking: AC: red, DC: blue, UC: white
- Due to high-quality design and no sharp edges no risk of injuries during installation
- Partition plates for optical separation and reinforcement of insulation

## General ordering data

Type	TRS 24-230VUC 2CO EMPTY	Version
Order No.	<a href="#">1124070000</a>	TERMSERIES, Relay socket, Number of contacts: 2, CO contact, Rated
GTIN (EAN)	4032248906024	control voltage: 24...230 V UC $\pm 10\%$ , Continuous current: 10 A,
Qty.	10 ST	Screw connection

## Tension clamp connection

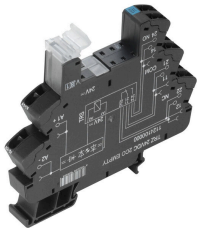

TERMSERIES empty sockets with:

- 2 CO contacts
- Unique multi-voltage input from 24 to 230 V UC
- Input voltages from 5 V DC to 230 V UC with coloured marking: AC: red, DC: blue, UC: white
- Due to high-quality design and no sharp edges no risk of injuries during installation
- Partition plates for optical separation and reinforcement of insulation

## General ordering data

Type	TRZ 24-230VUC 2CO EMPTY	Version
Order No.	<a href="#">1124190000</a>	TERMSERIES, Relay socket, Number of contacts: 2, CO contact, Rated
GTIN (EAN)	4032248905782	control voltage: 24...230 V UC $\pm 10\%$ , Continuous current: 10 A,
Qty.	10 ST	Tension-clamp connection

## PUSH IN connection

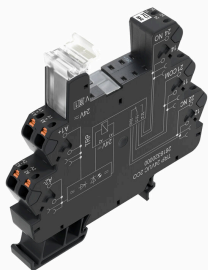

TERMSERIES empty sockets with:

- 2 CO contacts
- Unique multi-voltage input from 24 to 230 V UC
- Input voltages from 5 V DC to 230 V UC with coloured marking: AC: red, DC: blue, UC: white
- Due to high-quality design and no sharp edges no risk of injuries during installation
- Partition plates for optical separation and reinforcement of insulation

## General ordering data

Type	TRP 24-230VUC 2CO EMPTY...	Version
Order No.	<a href="#">2663060000</a>	TERMSERIES, Relay socket, Number of contacts: 2, CO contact, Rated
GTIN (EAN)	4050118698015	control voltage: 24...230 V UC $\pm 10\%$ , Continuous current: 10 A,
Qty.	10 ST	PUSH IN

## RCL425024

**Weidmüller Interface GmbH & Co. KG**  
 Klingenbergstraße 26  
 D-32758 Detmold  
 Germany

## Counterpart

www.weidmueller.com

### Screw connection

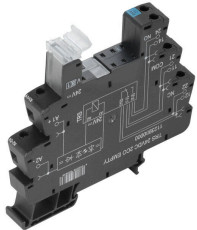

TERMSERIES empty sockets with:

- 2 CO contacts
- Unique multi-voltage input from 24 to 230 V UC
- Input voltages from 5 V DC to 230 V UC with coloured marking: AC: red, DC: blue, UC: white
- Due to high-quality design and no sharp edges no risk of injuries during installation
- Partition plates for optical separation and reinforcement of insulation

### General ordering data

Type	TRS 24VDC 2CO EMPTY	Version
Order No.	<a href="#">1123980000</a>	TERMSERIES, Relay socket, Number of contacts: 2, CO contact, Rated control voltage: 24 V DC $\pm 20\%$ , Continuous current: 10 A, Screw connection
GTIN (EAN)	4032248905997	
Qty.	10 ST	
Type	TRS 24VUC 2CO EMPTY	Version
Order No.	<a href="#">1123990000</a>	TERMSERIES, Relay socket, Number of contacts: 2, CO contact, Rated control voltage: 24 V UC $\pm 10\%$ , Continuous current: 10 A, Screw connection
GTIN (EAN)	4032248905805	
Qty.	10 ST	

### Tension clamp connection

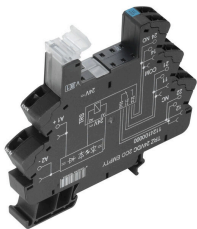

TERMSERIES empty sockets with:

- 2 CO contacts
- Unique multi-voltage input from 24 to 230 V UC
- Input voltages from 5 V DC to 230 V UC with coloured marking: AC: red, DC: blue, UC: white
- Due to high-quality design and no sharp edges no risk of injuries during installation
- Partition plates for optical separation and reinforcement of insulation

### General ordering data

Type	TRZ 24VDC 2CO EMPTY	Version
Order No.	<a href="#">1124100000</a>	TERMSERIES, Relay socket, Number of contacts: 2, CO contact, Rated control voltage: 24 V DC $\pm 20\%$ , Continuous current: 10 A, Tension-clamp connection
GTIN (EAN)	4032248906048	
Qty.	10 ST	
Type	TRZ 24VUC 2CO EMPTY	Version
Order No.	<a href="#">1124110000</a>	TERMSERIES, Relay socket, Number of contacts: 2, CO contact, Rated control voltage: 24 V UC $\pm 10\%$ , Continuous current: 10 A, Tension-clamp connection
GTIN (EAN)	4032248906031	
Qty.	10 ST	

## RCL425024

**Weidmüller Interface GmbH & Co. KG**  
 Klingenbergstraße 26  
 D-32758 Detmold  
 Germany

www.weidmueller.com

## Counterpart

## Screw connection

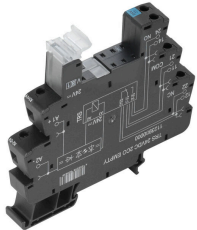

TERMSERIES empty sockets with:

- 2 CO contacts
- Unique multi-voltage input from 24 to 230 V UC
- Input voltages from 5 V DC to 230 V UC with coloured marking: AC: red, DC: blue, UC: white
- Due to high-quality design and no sharp edges no risk of injuries during installation
- Partition plates for optical separation and reinforcement of insulation

## General ordering data

Type	TRS 24-230VUC 2CO EMPTY	Version	
Order No.	<a href="#">1124070000</a>	TERMSERIES, Relay socket, Number of contacts: 2, CO contact, Rated	
GTIN (EAN)	4032248906024	control voltage: 24...230 V UC $\pm 10\%$ , Continuous current: 10 A,	
Qty.	10 ST	Screw connection	

## Tension clamp connection

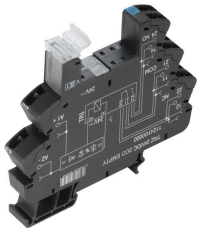

TERMSERIES empty sockets with:

- 2 CO contacts
- Unique multi-voltage input from 24 to 230 V UC
- Input voltages from 5 V DC to 230 V UC with coloured marking: AC: red, DC: blue, UC: white
- Due to high-quality design and no sharp edges no risk of injuries during installation
- Partition plates for optical separation and reinforcement of insulation

## General ordering data

Type	TRZ 24-230VUC 2CO EMPTY	Version	
Order No.	<a href="#">1124190000</a>	TERMSERIES, Relay socket, Number of contacts: 2, CO contact, Rated	
GTIN (EAN)	4032248905782	control voltage: 24...230 V UC $\pm 10\%$ , Continuous current: 10 A,	
Qty.	10 ST	Tension-clamp connection	

## PUSH IN connection

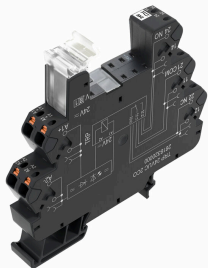

TERMSERIES empty sockets with:

- 2 CO contacts
- Unique multi-voltage input from 24 to 230 V UC
- Input voltages from 5 V DC to 230 V UC with coloured marking: AC: red, DC: blue, UC: white
- Due to high-quality design and no sharp edges no risk of injuries during installation
- Partition plates for optical separation and reinforcement of insulation

## General ordering data

Type	TRP 24VDC 2CO EMPTY	Version	
Order No.	<a href="#">2680970000</a>	TERMSERIES, Relay socket, Number of contacts: 2, CO contact, Rated	
GTIN (EAN)	4050118695175	control voltage: 24 V DC $\pm 20\%$ , Continuous current: 10 A, PUSH IN	
Qty.	10 ST		

## RCL425024

Weidmüller Interface GmbH &amp; Co. KG

Klingenbergstraße 26

D-32758 Detmold

Germany

www.weidmueller.com

## Counterpart

Type	TRP 24VUC 2CO EMPTY	Version
Order No.	<a href="#">2680980000</a>	TERMSERIES, Relay socket, Number of contacts: 2, CO contact, Rated
GTIN (EAN)	4050118695182	control voltage: 24 V UC $\pm$ 10 %, Continuous current: 10 A, PUSH IN
Qty.	10 ST	
Type	TRP 24-230VUC 2CO EMPTY...	Version
Order No.	<a href="#">2663060000</a>	TERMSERIES, Relay socket, Number of contacts: 2, CO contact, Rated
GTIN (EAN)	4050118698015	control voltage: 24...230 V UC $\pm$ 10 %, Continuous current: 10 A,
Qty.	10 ST	PUSH IN

## Screw connection

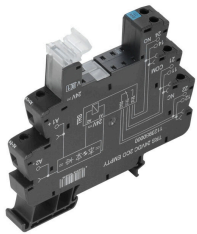

TERMSERIES empty sockets with:

- 2 CO contacts
- Unique multi-voltage input from 24 to 230 V UC
- Input voltages from 5 V DC to 230 V UC with coloured marking: AC: red, DC: blue, UC: white
- Due to high-quality design and no sharp edges no risk of injuries during installation
- Partition plates for optical separation and reinforcement of insulation

## General ordering data

Type	TRS 24-230VUC 2CO EMPTY...	Version
Order No.	<a href="#">2662900000</a>	TERMSERIES, Relay socket, Number of contacts: 2, CO contact, Rated
GTIN (EAN)	4050118698176	control voltage: 24...230 V UC $\pm$ 10 %, Continuous current: 10 A,
Qty.	10 ST	Screw connection